



buffet | tabletop | bar



*SINCE 1933*

**2026**  
NOVELTIES  
SPRING

The image shows a top-down view of a dining table. The table is covered with a white surface that has a pattern of light blue and white geometric shapes, including triangles and rectangles. Several light blue plates are arranged on the table. One plate in the upper right contains a small, round, dark-colored appetizer with a white center, garnished with green herbs and a slice of yellow citrus. Another plate in the lower right shows a white, creamy dish, possibly a risotto or pasta, garnished with green herbs and a slice of yellow citrus. A white circular callout is positioned in the center-left of the image, containing the text "DISCOVER OVER 300 NEW PRODUCTS!".

DISCOVER  
OVER **300 NEW**  
**PRODUCTS!**



# NEW PRODUCTS

Spring 2026

## Nie war unser Frühling vielfältiger

Über 300 Produkte feiern Premiere – zahlreiche Ergänzungen schließen Lücken in bestehenden Linien, neue Farbvarianten schärfen die visuelle Aussage, und ganz neue Serien eröffnen zusätzliche Spielräume in Design und Funktion. Über alle Produktwelten hinweg entsteht ein in sich stimmiges, aufeinander abgestimmtes Sortiment: Größen und Proportionen greifen ineinander, Varianten lassen sich nahtlos kombinieren – mit durchdachter Systemlogik, hoher Alltagstauglichkeit und klarer, durchgängiger Gestaltung.

## Never has our spring been more diverse

Over 300 products are making their debut – numerous additions close gaps in existing lines, new colour variants sharpen the visual statement, and entirely new series open up additional possibilities in design and function. Across all product worlds, a coherent, well-balanced range is emerging: sizes and proportions interlock, variants can be combined seamlessly – with a thoughtful system logic, high everyday practicality, and a clear, consistent design language.

p. 16



p. 44



p. 56



p. 84



p. 96



p. 100





**GN 1/1 Holzbox „VALO“**

GN 1/1 woodbox  
GN 1/1 caja madera  
GN 1/1 base bois

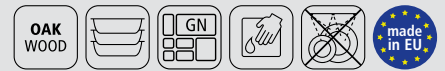

	cm	cm	GN	Farbe / colour
14000	53 x 32,5	4,5	1/1	(oiled)
14001	53 x 32,5	8,5	1/1	(oiled)
14002	53 x 32,5	16,5	1/1	(oiled)
14100	53 x 32,5	4,5	1/1	(lacquered)
14101	53 x 32,5	8,5	1/1	(lacquered)
14102	53 x 32,5	16,5	1/1	(lacquered)





**GN 1/2 Holzbox „VALO“**

GN 1/2 woodbox  
GN 1/2 caja madera  
GN 1/2 base bois



	cm	cm	GN	Farbe / colour
14003	32,5 x 26,5	4,5	1/2	(oiled)
14004	32,5 x 26,5	8,5	1/2	(oiled)
14005	32,5 x 26,5	16,5	1/2	(oiled)
14103 <b>NEW</b>	32,5 x 26,5	4,5	1/2	(lacquered)
14104 <b>NEW</b>	32,5 x 26,5	8,5	1/2	(lacquered)
14105 <b>NEW</b>	32,5 x 26,5	16,5	1/2	(lacquered)

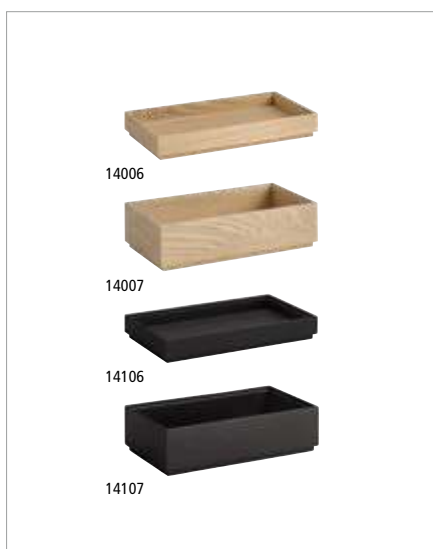

**GN 1/3 Holzbox „VALO“**

GN 1/3 woodbox  
GN 1/3 caja madera  
GN 1/3 base bois



	cm	cm	GN	Farbe / colour
14006	32,5 x 17,6	4,5	1/3	(oiled)
14007	32,5 x 17,6	8,5	1/3	(oiled)
14106 <b>NEW</b>	32,5 x 17,6	4,5	1/3	(lacquered)
14107 <b>NEW</b>	32,5 x 17,6	8,5	1/3	(lacquered)



**GN 1/6 Holzbox „VALO“**

GN 1/6 woodbox  
GN 1/6 caja madera  
GN 1/6 base bois



	cm	cm	GN	Farbe / colour
14027	17,6 x 16,2	8,5	1/6	(oiled)
14127	17,6 x 16,2	8,5	1/6	(lacquered)



**GN 2/4 Holzbox „VALO“**

GN 2/4 woodbox  
GN 2/4 caja madera  
GN 2/4 base bois

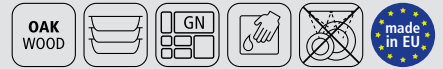

	cm	cm	GN	Farbe / colour
14008	53 x 16,2	4,5	2/4	(oiled)
14009	53 x 16,2	8,5	2/4	(oiled)
14108 <small>NEW</small>	53 x 16,2	4,5	2/4	(lacquered)
14109 <small>NEW</small>	53 x 16,2	8,5	2/4	(lacquered)



**GN Naturschieferplatte**

GN natural slate tray  
GN bandeja de pizarra natural  
GN plat ardoise naturelle



**Schieferplatten mit möbelschonenden Füßchen – ideal als Auflage für GN Holzboxen**  
slate trays with furniture-friendly feet – ideal as an overlay for GN wooden boxes  
bandejas pizarra con pies protege-muebles – ideales como soporte para cajas de madera GN  
plateaux en ardoise avec pieds protégé-meubles – idéals pour les caisses en bois GN

	cm	✦ mm	GN
01001	53,0 x 32,5	6-9	1/1
01003	32,5 x 26,5	6-9	1/2
01004	32,5 x 17,6	6-9	1/3
01002	53,0 x 16,2	6-9	2/4



**Einsatz für GN 1/1 Holzbox „VALO“**

insert for GN 1/1 woodbox  
separador para GN 1/1 caja madera  
insert pour GN 1/1 base bois



**Einsatz ergibt 15 Fächer (9,5 x 9,5 cm)**  
insert creates 15 compartments (9,5 x 9,5 cm)  
separador ofrece 15 compartimentos (9,5 x 9,5 cm)  
insert donnant 15 compartiments (9,5 x 9,5 cm)

	cm	cm	fits to	fits to
14021	50,5 x 30	6	GN 1/1	14001, 14101





**Einsatz für GN 1/2 Holzbox, 2er Set „VALO“**

insert for GN 1/2 woodbox, set of 2  
 separador para GN 1/2 caja madera, set de 2  
 insert pour GN 1/2 base bois, set de 2



**Einsatz ergibt 3 Fächer, ideal für Besteck**

insert creates 3 compartments, ideal for cutlery  
 separador ofrece 3 compartimentos, ideal para cubiertos  
 insert donnant 3 compartiments, idéal pour les couverts

	cm	cm	fits to	pcs.
14022	24 x 10,5	6	GN 1/2, 14004, 14104	2



**Einsatz für GN Holzbox „VALO“**

insert for GN woodbox  
 inserto para GN caja madera  
 insert pour GN base bois



**passende Einsätze für GN Holzboxen, ideal zum Befüllen mit Crushed Eis**

suitable insert for GN wooden boxes, ideal for filling with crushed ice  
 inserto para cajas de madera GN, ideal para rellenar con hielo picado  
 insert supérieur pour caisses en bois GN, idéal pour le remplissage avec de la glace pilée

	cm	cm	GN	fits to
14041	51,5 x 31	6	1/1	14001, 14101
14036	51,5 x 31	14	1/1	14002, 14102
14042	31,0 x 25	6	1/2	14004, 14104
14037	31,0 x 25	14	1/2	14005, 14105
14043 <small>NEW</small>	51,5 x 15	6	2/4	14009, 14109



**Antirutschmatte für GN Holzbox „VALO“**

anti-slip mat for GN woodbox  
 alfombra antideslizante para GN caja madera  
 tapis antidérapant pour GN base bois



**zur Einlage in GN Holzboxen, schützt das Holz vor fettenden oder ölhaltigen Lebensmitteln**

for insertion into GN wooden boxes, protects the wood from greasy or oily foods  
 para colocar en cajas de madera GN, protege la madera de alimentos grasos o aceitosos  
 a placer dans des caisses en bois GN, protège le bois des aliments gras ou huileux

	cm	fits to
14038	50,4 x 30,0	GN 1/1
14039	30,0 x 24,1	GN 1/2
14040	50,4 x 13,8	GN 2/4



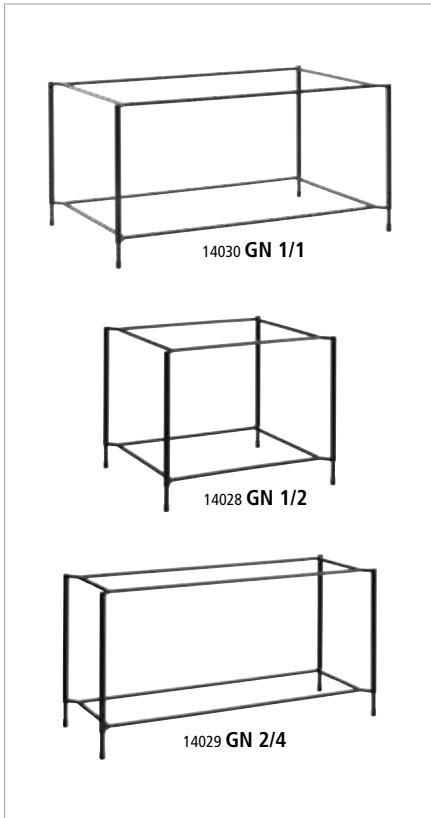

**GN Buffetständer „VALO“**

GN buffet stand  
GN soporte para buffet  
GN présentoir buffet



**multifunktionaler, stapelbarer Buffetständer aus pulverbeschichtetem Metall**

multifunctional, stackable buffet stand made of powder-coated metal  
soporte multifuncional apilable para buffet fabricado en metal con recubrimiento en polvo  
support de buffet multifonctionnel empilable en métal revêtu par poudre

	cm	cm	GN
14030	57,0 x 37	28,5	1/1
14028 <small>NEW</small>	36,5 x 31	28,5	1/2
14029 <small>NEW</small>	57,0 x 21	28,5	2/4

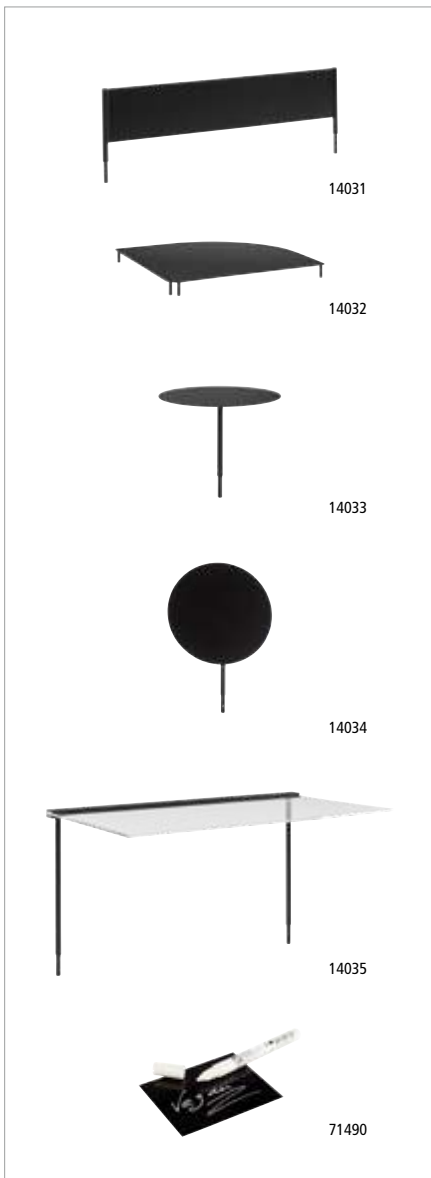

**Buffetständer Zubehör „VALO“**

buffet stand accessories  
accesorios para soportes de buffet  
accessoires pour présentoirs de buffet



**multifunktionales Zubehör aus pulverbeschichtetem Metall:**

• Stecktafel (beschriftbar) • Eckverbindung • Podest • Schild (beschriftbar) • Hygieneschutz

multifunctional accessories made of powder-coated metal:

• pegboard • corner connection • platform • shield • hygienic protection

accesorios multifuncionales de metal con recubrimiento en polvo:

• tablero de anuncios • conexión de esquina • plataforma • cartel • protección higiénica

accessoires multifonctionnels en métal thermolaqué:

• panneau d'affichage • raccord d'angle • plateforme • panneau • protection hygiénique

	cm	cm	fits to
14031	57,0 x 1,0	19,5	14029, 14030
14032	39,0 x 39,0	3,0	14028, 14030
14033	Ø 25	20,5	14028, 14029, 14030
14034	Ø 25	33,0	14028, 14029, 14030
14035	60,5 x 36,5	33,5	14029, 14030

**Kreidemarker, 2er Set**

chalk marker, set of 2  
rotulador de tiza, set de 2  
marqueur a la craie liquide, set de 2



	Ø cm	cm	Farbe / colour	pcs.
71490	1	13		2





### Etagère, 3-stufig „VALO“

3-tier tray  
bandeja 3 alturas  
étagère carré 3 hauteurs



**untere Ebene GN 1/1, mittlere Ebene 53 x 26,5 cm, obere Ebene GN 2/4**

lower level GN 1/1, middle level 53 x 26,5 cm, upper level GN 2/4

nivel inferior GN 1/1, nivel medio 53 x 26,5 cm, nivel superior GN 2/4

niveau inférieur GN 1/1, niveau intermédiaire 53 x 26,5 cm, niveau supérieur GN 2/4

	cm	cm	fits to
14012	55,5 x 32,5	64	GN 1/1, 2/4



### Etagère, 2-stufig „VALO“

2-tier tray  
bandeja 2 alturas  
étagère carré 2 hauteurs



**untere Ebene 53 x 26,5 cm, obere Ebene GN 2/4**

lower level 53 x 26,5 cm, upper level GN 2/4

nivel inferior 53 x 26,5 cm, nivel superior GN 2/4

niveau inférieur 53 x 26,5 cm, niveau supérieur GN 2/4

	cm	cm	fits to
14011	55,5 x 26,5	44,5	GN 2/4



### Etagère, 2-stufig „VALO“

2-tier tray  
bandeja 2 alturas  
étagère carré 2 hauteurs



**untere Ebene GN 1/2, obere Ebene GN 1/3**

lower level GN 1/2, upper level GN 1/3

nivel inferior GN 1/2, nivel superior GN 1/3

niveau inférieur GN 1/2, niveau supérieur GN 1/3

	cm	cm	fits to
14010	35,0 x 26,5	44,5	GN 1/2, 1/3



### Etagère, 3-stufig „VALO“

3-tier tray  
bandeja 3 alturas  
étagère carré 3 hauteurs



**untere Ebene Ø 30 cm, mittlere Ebene Ø 25 cm, obere Ebene Ø 17 cm**

lower level Ø 30 cm, middle level Ø 25 cm, upper level Ø 17 cm

nivel inferior Ø 30 cm, nivel medio Ø 25 cm, nivel superior Ø 17 cm

niveau inférieur Ø 30 cm, niveau intermédiaire Ø 25 cm, niveau supérieur Ø 17 cm

	Ø cm	cm
14014	30	42



### Etagère, 2-stufig „VALO“

2-tier tray  
bandeja 2 alturas  
étagère carré 2 hauteurs



**untere Ebene Ø 30 cm, obere Ebene Ø 25 cm**

lower level Ø 30 cm, upper level Ø 25 cm

nivel inferior Ø 30 cm, nivel superior Ø 25 cm

niveau inférieur Ø 30 cm, niveau supérieur Ø 25 cm

	Ø cm	cm
14013	30	28

NEW



14024



**Buffetgestell für GN Holzboxen „VALO“**

buffet stand for GN wooden boxes  
 soporte para buffet para cajas de madera GN  
 présentoir buffet pour caisses en bois GN  
**multifunktionales Gestell, kombinierbar mit GN Holzboxen**  
 multifunctional rack, can be combined with GN wooden boxes  
 estructura multifuncional, combinable con cajas de madera GN  
 support multifonctionnel, combinable avec des caisses en bois GN

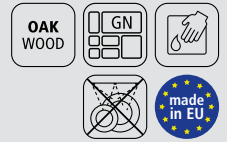

	cm	cm	fits to
14024	55,5 x 32	32	GN wooden boxes

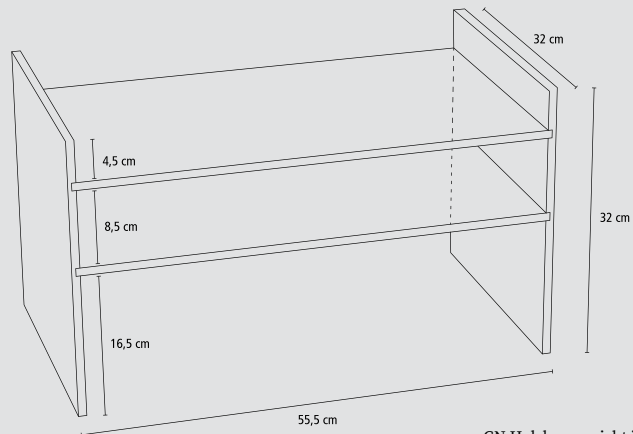

GN Holzboxen nicht im Lieferumfang enthalten  
 GN wooden boxes not included in delivery



01002  
1x GN 2/4



14009  
1x GN 2/4



14008  
1x GN 2/4



14004  
2x GN 1/2



14002  
1x GN 1/1



**Etagère, 2-stufig „VALO“**

2-tier tray  
bandeja 2 alturas  
étagère carré 2 hauteurs



**untere Ebene 52 x 26,5 cm, obere Ebene 52 x 16 cm**  
lower level 52 x 26,5 cm, upper level 52 x 16 cm  
nivel inferior 52 x 26,5 cm, nivel superior 52 x 16 cm  
niveau inférieur 52 x 26,5 cm, niveau supérieur 52 x 16 cm

	cm	cm
14020	54 x 26,5	26,5



**angewinkelte Innenbox für ideale Präsentation**  
angled inner box for ideal presentation



**GN 1/1 Brotschneidebrett „VALO“**

GN 1/1 cutting board  
GN 1/1 tabla de cortar  
GN 1/1 planche à découper

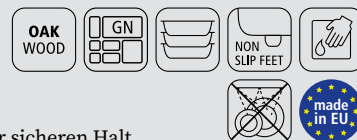

**massives Brotschneidebrett mit Antirutschfüßchen für sicheren Halt**  
solid cutting board with non-slip feet for a secure hold  
tabla de cortar pan maciza con pies antideslizantes para una sujeción segura  
planche à découper massive avec pieds antidérapants pour une bonne stabilité

	cm	cm	GN
00764	53 x 32,5	3,5	1/1



**Brotmesser**

bread knife  
cuchillo para pan  
couteau à pain



**Brotmesser aus rostfreiem Edelstahl, dreifach genietet, mit Griff aus Buchenholz**  
bread knife made of stainless steel, triple riveted, with beech wood handle  
cuchillo para pan de acero inoxidable, triple remachado, con mango de madera de haya  
couteau à pain en acier inox, triplement riveté, avec manche en bois de hêtre

	→ cm
88990	34

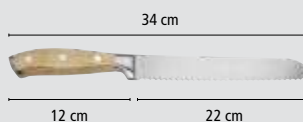

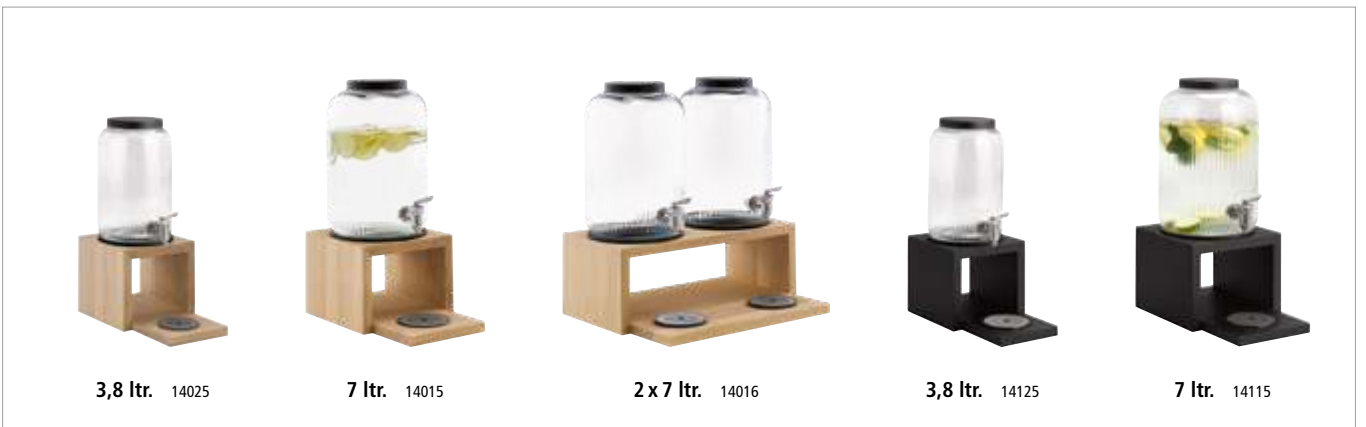

**Getränkespender „VALO“**

beverage dispenser  
dispensador de bebidas  
distributeur de boissons

Podest wasserfest lackiert, Zapfhahn aus Edelstahl,  
Untersetzer aus Melamin, Bodenplatte (Gläserntablett) herausnehmbar

platform waterproof lacquered, stainless steel tap,  
melamine coaster, removeable base plate

podio con barniz impermeable, grifo de acero inoxidable,  
posavasos de melamina, placa base extraíble

podium verni imperméable, robinet en acier inox,  
dessous de verre en mélamine, plaque de fond amovible



	cm	cm	ltr.	Farbe / colour
14025	18,0 x 18,0	41,0	3,8	
14015	21,0 x 21,0	46,5	7,0	
14016	43,5 x 21,0	46,5	2x 7,0	
14125 <b>NEW</b>	18,0 x 18,0	41,0	3,8	
14115 <b>NEW</b>	21,0 x 21,0	46,5	7,0	



### Eiswasserröhre

ice cube cooling tube  
tubo enfriador para cubitos  
tube pour glaçons

	Ø cm	cm	fits to
10849	11	23	14015, 14016, 14025, 14115, 14125



10725  
0,5 ltr.

10726  
1,0 ltr.

10727  
1,5 ltr.

### Glaskaraffe „LINES“

glass carafe  
jarra de vidrio  
carafe en verre

ideal für Cerealien, Säfte oder Milch, Deckel aus Kork

ideal for cereals, juices or milk, cork lid

ideal para cereales, zumos o leche, tapa de corcho

idéal pour les céréales, les jus de fruits ou le lait, couvercle en liège

GLASS

CORK

	Ø cm	cm	ltr.	fits to
10725	9	19,5	0,5	14023, 14070, 14075, 14077, 14123, 14170
10726	9	27,5	1,0	14023, 14070, 14075, 14077, 14123, 14170
10727	9	35,0	1,5	14023, 14070, 14075, 14077, 14123, 14170



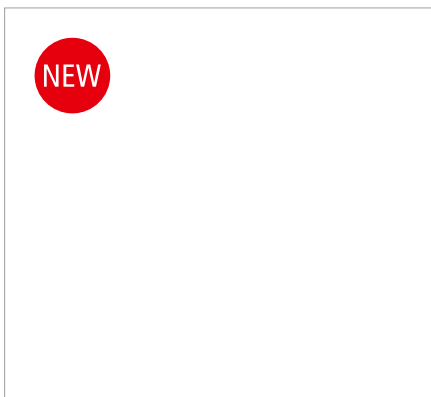

**Glaskaraffe „LINES“**

glass carafe  
jarra de vidrio  
carafe en verre



ideal für Milch oder Säfte, Deckel aus Kork  
ideal for milk or juices, cork lid  
ideal para leche o zumos, tapa de corcho  
idéal pour le lait ou les jus de fruits, couvercle en liège

	Ø cm	cm	ltr.	fits to
10735	9	27	1	10736, 14023, 14123

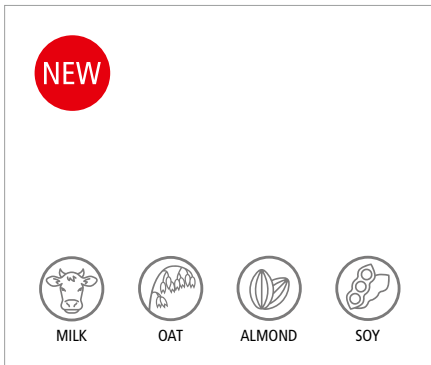

**Labelclips, 4er Set**

label clips, set of 4  
etiqueta clip, set de 4  
étiquette clip, set de 4



vier verschiedene Beschriftungen (milk, oat, almond, soy) – passend für Glaskaraffe Nr. 10735  
four different labels (milk, oat, almond, soy) – suitable for glass carafe no. 10735  
cuatro etiquetas diferentes (milk, oat, almond, soy) – aptas para jarra de cristal no. 10735  
quatre inscriptions différentes (milk, oat, almond, soy) – pour la carafe en verre no. 10735

	Ø cm	cm	fits to	pcs.
10736	4,5	2,5	10735	4

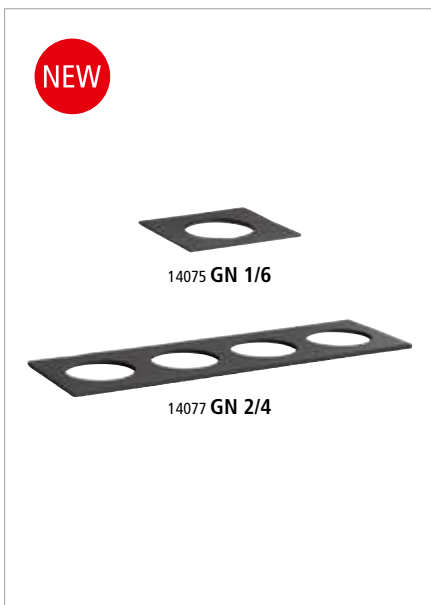

**GN Naturschieferplatte**

GN natural slate tray  
GN bandeja de pizarra natural  
GN plat ardoise naturelle



Schieferplatte mit Ausschnitt (Ø 10,5 cm) – passend für Glaskaraffe Nr. 10735  
slate plate with cut-out (Ø 10,5 cm) – suitable for glass carafe no. 10735  
placa de pizarra con recorte (Ø 10,5 cm) – apta para jarra de cristal no. 10735  
plaque d'ardoise avec découpe (Ø 10,5 cm) – pour la carafe en verre no. 10735

	cm	✂ mm	GN	fits to
14075	17,6 x 16,2	6-9	1/6	14027, 14127
14077	53,0 x 16,2	6-9	2/4	14009, 14109



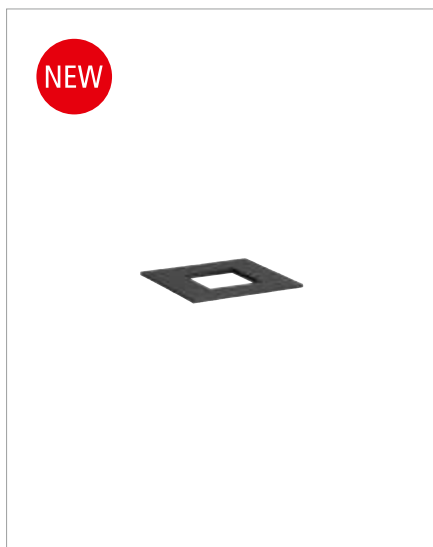

### GN 1/6 Naturschieferplatte

GN 1/6 natural slate tray  
GN 1/6 bandeja de pizarra natural  
GN 1/6 plat ardoise naturelle



**Schieferplatte mit Ausschnitt (8,3 x 8,3 cm) – passend für handelsübliche Milch- oder Saftkartons**

slate plate with cut-out (8,3 x 8,3 cm) – suitable for standard milk or juice cartons

placa de pizarra con recorte (8,3 x 8,3 cm) – para envases estándar de leche o zumo

plaque en ardoise avec découpe (8,3 x 8,3 cm) – pour briques de lait ou de jus standard

	cm	✂ mm	GN	fits to
14076	17,6 x 16,2	6-9	1/6	14027, 14127



### GN 1/6 Kühlbox, 4-tlg. Set „VALO“

GN 1/6 cool box, 4-piece set  
GN 1/6 nevera portátil, set de 4 piezas  
GN 1/6 glacière, set de 4 pièces



4-teiliges Set, bestehend aus:

- 1 GN 1/6 Holzbox, 1 Einsatz aus EPP, 1 Kühlakku aus PE, 1 GN 1/6 Naturschieferplatte mit Ausschnitt (Ø 10,5 cm)

4 pcs., consisting of:

- 1 GN 1/6 woodbox, 1 insert made of EPP, 1 cooling pack made of PE, 1 GN 1/6 natural slate plate with cut-out (Ø 10,5 cm)

set de 4, compuesto por:

- 1 caja de madera GN 1/6, 1 inserto de EPP, 1 acumulador de frío de PE, 1 placa de pizarra natural GN 1/6 con recorte (Ø 10,5 cm)

set de 4, composé de:

- 1 boîte en bois GN 1/6, 1 insert en EPP, 1 accumulateur de froid en PE, 1 plaque en ardoise naturelle GN 1/6 avec découpe (Ø 10,5 cm)

	cm	cm	GN	Farbe / colour
14070	17,6 x 16,2	9	1/6	(oiled)
14170	17,6 x 16,2	9	1/6	(lacquered)



### Kühlakku

cooler  
acumulador de frío  
accumulateur de froid



	cm	cm	fits to
10662 <span style="color:red">NEW</span>	Ø 10,5	2,0	14079
10791	25 x 19	2,5	14078



### Einsatz „VALO“

insert  
inserto  
insert



	cm	cm	fits to
14079	14 x 12,5	5	GN 1/6, GN 2/4
14078	30 x 24,0	4	GN 1/2, GN 1/1



**Frischhaltehaube „VALO“**

cover  
campana  
cloche



stilvoll abgedeckt und geschützt – passend für Servier- und Tortenplatten Nr. 14095 & 14096  
 stylishly covered and protected – compatible with cake stands no. 14095 & 14096  
 elegante y protegida – compatible con porta pasteles no. 14095 & 14096  
 couverts et protégés avec style – compatible avec présentoir à gâteaux no. 14095 & 14096

	Ø cm	cm	fits to
14097	30	16	14095, 14096, 19044, 19084



**Teller „THE GRID“**

plate  
plato  
assiette



	Ø cm	cm	fits to	Farbe / colour
19044	32,0	2,5	14097	 sand
19084	32,0	2,5	14097	 mud



NEW



### Servier- und Tortenplatte „VALO“

cake stand  
porta pasteles  
présentoir à gâteaux

für eine stilvolle Präsentation von Kuchen und Gebäck, Ø Standfuß: 12 cm

for a stylish presentation of cakes and pastries, Ø base: 12 cm

presentación elegante de pasteles y repostería, Ø base: 12 cm

présentation élégante de gâteaux et pâtisseries, Ø socle: 12 cm



	Ø cm	cm	fits to	Farbe / colour
14095	32	8,5	14097	(oiled)



NEW



### Servier- und Tortenplatte „VALO“

cake stand  
porta pasteles  
présentoir à gâteaux

für eine stilvolle Präsentation von Kuchen und Gebäck, Ø Standfuß: 15 cm

for a stylish presentation of cakes and pastries, Ø base: 15 cm

presentación elegante de pasteles y repostería, Ø base: 15 cm

présentation élégante de gâteaux et pâtisseries, Ø socle: 15 cm



	Ø cm	cm	fits to	Farbe / colour
14096	32	17	14097	(oiled)





**Glaskaraffe „LINES“**

glass carafe  
jarra de vidrio  
carafe en verre

GLASS CORK

ideal für Cerealien, Säfte oder Milch, Deckel aus Kork

ideal for cereals, juices or milk, cork lid

ideal para cereales, zumos o leche, tapa de corcho

idéal pour les céréales, les jus de fruits ou le lait, couvercle en liège

	Ø cm	cm	ltr.	fits to
10725	9	19,5	0,5	14023, 14123
10726	9	27,5	1,0	14023, 14123
10727	9	35,0	1,5	14023, 14123



**3er-Podest für Glaskaraffen „VALO“**

podest for 3 glass carafes  
pedestal para 3 jarras de vidrio  
podium pour 3 carafes en verre

OAK WOOD

ideal für eine stets geordnete Präsentation am Buffet

ideal for a constantly organised presentation at the buffet

ideal para una presentación constantemente organizada en el buffet

idéal pour une présentation toujours ordonnée au buffet

	cm	cm	fits to	Farbe / colour
14023	41 x 16	12	10725, 10726, 10727, 10735	(oiled)
14123	41 x 16	12	10725, 10726, 10727, 10735	(lacquered)



0,75 ltr.

**Glaskaraffe „LINES“**

glass carafe  
jarra de vidrio  
carafe en verre

GLASS

CORK

**ideal für Cerealien, Säfte oder Milch, Deckel aus Kork**

ideal for cereals, juices or milk, cork lid

ideal para cereales, zumos o leche, tapa de corcho

idéal pour les céréales, les jus de fruits ou le lait, couvercle en liège

	Ø cm	cm	ltr.	fits to
10738	8	28	0,75	14019

**1er-Podest für Glaskaraffen „VALO“**

podest for 1 glass carafe  
pedestal para 1 jarra de vidrio  
podium pour 1 carafe en verre

OAK  
WOOD**ideal für eine stets geordnete Präsentation am Buffet**

ideal for a constantly organised presentation at the buffet

ideal para una presentación constantemente organizada en el buffet

idéal pour une présentation toujours ordonnée au buffet

	cm	cm	fits to
14019	15 x 15	12	10738

**Serviettenhalter „VALO“**

napkin holder  
servilletero  
porte-serviettes

OAK  
WOOD

METAL

**für ca. 100 Servietten mit 1/4 Falz, inklusive Beschwerer**

for approx. 100 napkins with 1/4 fold, including weight

para aprox. 100 servilletas con 1/4 de pliegue, con barra de contrapeso

pour env. 100 serviettes pliées en 1/4, avec barre de contrepois

	cm	cm
14092	19 x 19	16

**Table Caddy „VALO“**

table caddy  
caddy de mesa  
caddy de table

OAK  
WOOD

METAL

**2 Fächer: 6 x 6 cm / 1 Fach: 6 x 13 cm**

2 compartments: 6 x 6 cm / 1 compartment: 6 x 13 cm

2 compart. 6 x 6 cm, 1 compart. 6 x 13 cm

2 compart. 6 x 6 cm, 1 compart. 6 x 13 cm

	cm	cm
14090	15 x 15	28

**Table Caddy „VALO“**

table caddy  
caddy de mesa  
caddy de table

OAK  
WOOD**2 Fächer: 6 x 6 cm / 1 Fach: 6 x 13 cm**

2 compartments: 6 x 6 cm / 1 compartment: 6 x 13 cm

2 compart. 6 x 6 cm, 1 compart. 6 x 13 cm

2 compart. 6 x 6 cm, 1 compart. 6 x 13 cm

	cm	cm
14091	15 x 15	31



14050

14150

**Induktionsstation, 2-tlg. Set „VALO“**

induction station, 2-piece set  
 estación de inducción, set de 2 piezas  
 station à induction, set de 2 pièces



2-teiliges Set, bestehend aus:

- 1 Induktionskochplatte inklusive Kabelfernbedienung, Leistung in Stufen regelbar
- 1 Rahmen (wasserfest lackiert)

2 pcs., consisting of:

- 1 induction hotplate including cable remote control, power adjustable in steps
- 1 frame (waterproof lacquered)

set de 2, compuesto por:

- 1 placa de inducción con mando a distancia con cable, potencia regulable por niveles
- 1 marco (barnizado resistente al agua)

set de 2, composé de :

- 1 plaque à induction avec télécommande filaire, puissance réglable par paliers
- 1 cadre (vernis imperméable)

	cm	cm		Farbe / colour
14050	38,5 x 38,5	10	2000 W	
14150 <span style="color: red;">NEW</span>	38,5 x 38,5	10	2000 W	



Kabelfernbedienung  
 cable remote control



### Serviertablett „VALO“

tray  
bandeja  
plateau



**Innenmaß 56 x 36 cm, kombinierbar mit dem Tablettständer Nr. 14061**

inside dimension 56 x 36 cm, can be combined with tray stand no. 14061

dimension interior 56 x 36 cm, combinable con el soporte para bandejas no. 14061

dimension intérieure 56 x 36 cm, combinable avec le support pour plateau no. 14061

	cm	cm	fits to
14060	60 x 40	3	14061



### Tablettständer „VALO“

tray stand  
soporte para bandeja  
support de plateau



**zusammenklappbar, kombinierbar mit dem Serviertablett Nr. 14060, Tragfähigkeit: 50 kg**

collapsible, can be combined with serving tray no. 14060, load capacity: 50 kg

plegable, combinable con la bandeja de servicio no. 14060, capacidad de carga: 50 kg

pliable, combinable avec le plateau de service no. 14060, capacité de charge: 50 kg

	cm	cm	fits to
14061	56 x 35,5	75	14060



mit Magnetbefestigung  
with magnetic attachment





## VALUMO – Ihr Buffet, perfekt beleuchtet. Kabellos. Flexibel. Stilvoll.

VALUMO – Your buffet, perfectly illuminated.  
Wireless. Flexible. Stylish.

Das Buffet-Beleuchtungssystem **VALUMO** überzeugt durch seine Kombination aus modernem Design und praktischer Funktionalität. Es besteht aus den Leuchtköpfen Nr. 17090 & 17096 und fünf flexiblen Halterungen. Dank der Magnetkugelfestigung lässt sich der Leuchtkopf nahezu 360 Grad drehen, um das Licht präzise auszurichten.

Die Steuerung erfolgt ganz bequem über eine Fernbedienung oder direkt über den Touch-Button am Gehäuse. Mit Kaltweiß, Warmweiß und RGB-Farben bietet **VALUMO** vielfältige Beleuchtungsoptionen für jede Stimmung und jeden Anlass.

Der Leuchtkopf wird über die mitgelieferte Ladeplatte oder die optional erhältlichen Mehrfach-Ladeplatten aufgeladen – eine Lösung, die kabellosen Komfort und maximale Flexibilität garantiert.

**VALUMO** ist die ideale Ergänzung für jedes Buffet und eignet sich perfekt für unser Buffetsystem **VALO**. Es lässt sich nahtlos integrieren und flexibel kombinieren, um individuellen Anforderungen gerecht zu werden.

The **VALUMO** buffet lighting system impresses with its combination of modern design and practical functionality. It consists of the light heads no. 17090 & 17096 and five flexible brackets. Thanks to the magnetic ball attachment, the light head can be rotated almost 360 degrees to precisely align the light.

It can be conveniently controlled via a remote control or directly via the touch button on the housing. With cool white, warm white and RGB colours, **VALUMO** offers a wide range of lighting options for every mood and occasion.

The light head is charged via the supplied charging plate or the optionally available multiple charging plates - a solution that guarantees wireless convenience and maximum flexibility.

**VALUMO** is the ideal addition to any buffet and the perfect complement to our **VALO** buffet system. It integrates seamlessly and can be flexibly combined to meet individual requirements.



Magnetkugelfestigung  
magnetic ball mounting



nahezu 360 Grad drehbar  
almost 360 degrees rotatable



Ladestation  
charging station



### Leuchtkopf light head cabezal luminoso tête lumineuse



inklusive Ladestation, USB Ladekabel (ohne Netzteil), Fernbedienung inklusive Batterie  
charging station included, USB charging cable (without mains adapter), remote control including battery  
con estación de carga, cable de carga USB (sin adaptador de red), mando a distancia con pila incluida  
avec station de charge, câble de charge USB (sans bloc d'alimentation), télécommande incluse pile

	∅ cm	cm
17096	10,0	4,5



### Leuchtkopf light head cabezal luminoso tête lumineuse



inklusive Ladestation, USB Ladekabel (ohne Netzteil), Fernbedienung inklusive Batterie  
charging station included, USB charging cable (without mains adapter), remote control including battery  
con estación de carga, cable de carga USB (sin adaptador de red), mando a distancia con pila incluida  
avec station de charge, câble de charge USB (sans bloc d'alimentation), télécommande incluse pile

	∅ cm	cm
17090	7,5	5,0



**2er Standfuß inklusive Stab „VALUMO“**

2-piece stand including rod  
soporte de 2 con varilla incluida  
piéd de 2 avec tige incluse

**bestehend aus 3 Elementen: Standfuß mit Stab, Erweiterungsstab, Magnetkugeln**

consisting of 3 elements: stand with rod, extension rod, magnetic spheres  
compuesto por 3 elementos: soporte con varilla, varilla de prolongación, esferas magnéticas  
composé de 3 éléments : pied avec tige, tige de rallonge, boules magnétiques

	∅ cm	cm
17095	17	31 - 51



**1er Standfuß inklusive Stab „VALUMO“**

stand including rod  
soporte con varilla incluida  
piéd de support, tige incluse

**bestehend aus 3 Elementen: Standfuß mit Stab, Erweiterungsstab, Magnetkugel**

consisting of 3 elements: stand with rod, extension rod, magnetic sphere  
compuesto por 3 elementos: soporte con varilla, varilla de prolongación, esfera magnética  
composé de 3 éléments : pied avec tige, tige de rallonge, boule magnétique

	∅ cm	cm
17092	14	31 - 51

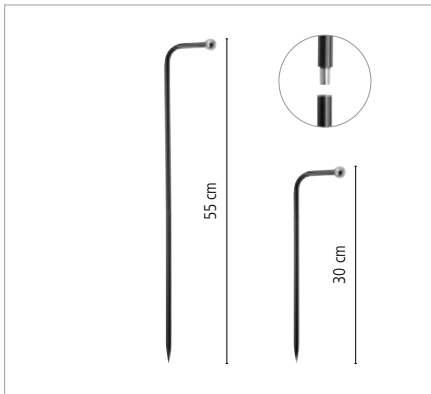

**Stab zum Stecken „VALUMO“**

stick for insertion  
varilla de inserción  
tige à enfoncer

**bestehend aus 3 Elementen: Spitze (24 cm), Erweiterungsstab, Magnetkugel**

consisting of 3 elements: tip (24 cm), extension rod, magnetic sphere  
compuesto por 3 elementos: punta (24 cm), varilla de prolongación, esfera magnética  
composé de 3 éléments : pointe (24 cm), tige de rallonge, boule magnétique

	∅ cm	cm	fits to
17093	0,9	30 - 55	14028, 14029, 14030

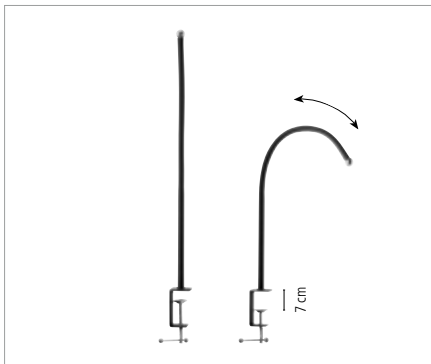

**Schraubklammer mit flexiblem Arm „VALUMO“**

screw clamp with flexible arm  
abrazadera de tornillo con brazo flexible  
pince à visser avec bras flexible

**zum Befestigen an Buffetelementen oder Tischplatten, mit flexiblem Arm**

for attachment to buffet elements or table tops, with flexible arm  
para fijar a elementos de buffet o tableros de mesa, con brazo flexible  
à fixer sur des éléments de buffet ou des plateaux de table, avec bras flexible

	cm	cm
17094	4,5 x 4	64

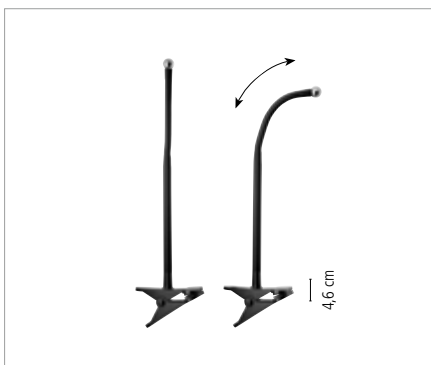

**Klammer mit flexiblem Arm „VALUMO“**

clamp with flexible arm  
pinza con brazo flexible  
agrafe avec bras flexible

**zum einfachen Befestigen an Buffetelementen oder Tischplatten, mit flexiblem Arm**

for easy attachment to buffet elements or table tops, with flexible arm  
para fijar fácilmente a elementos de buffet o tableros de mesa, con brazo flexible  
pour une fixation facile sur des éléments de buffet ou des plateaux de table, avec bras flexible

	cm	cm
17091	11 x 7,5	40





When buffet meets table –  
a modular link





THE GRID überträgt das modulare Prinzip von VALO auf eine neue Ebene: Das System schafft fließende Übergänge zwischen Buffet und Tisch – für ein durchgängiges Konzept, das Effizienz, Design und Atmosphäre harmonisch verbindet.

THE GRID takes the modular principle of VALO to a new level: the system creates seamless transitions between buffet and table – delivering a coherent concept that harmoniously combines efficiency, design and atmosphere.

THE GRID lleva el principio modular de VALO a un nuevo nivel: el sistema crea transiciones fluidas entre el bufé y la mesa, dando lugar a un concepto continuo que combina de forma armoniosa eficiencia, diseño y ambiente.

THE GRID transpose le principe modulaire de VALO dans une nouvelle dimension : le système crée des transitions fluides entre le buffet et la table et développe un concept cohérent où efficacité, design et atmosphère s'unissent naturellement.

# THE GRID

25 porcelain items, 6 glass items and 6 wood items –  
one fully combinable system, seamlessly compatible with VALO.

Diameter: cm    4,5                  6                  7,5                  9\*                  12,5                  14\*                  16

Height: cm

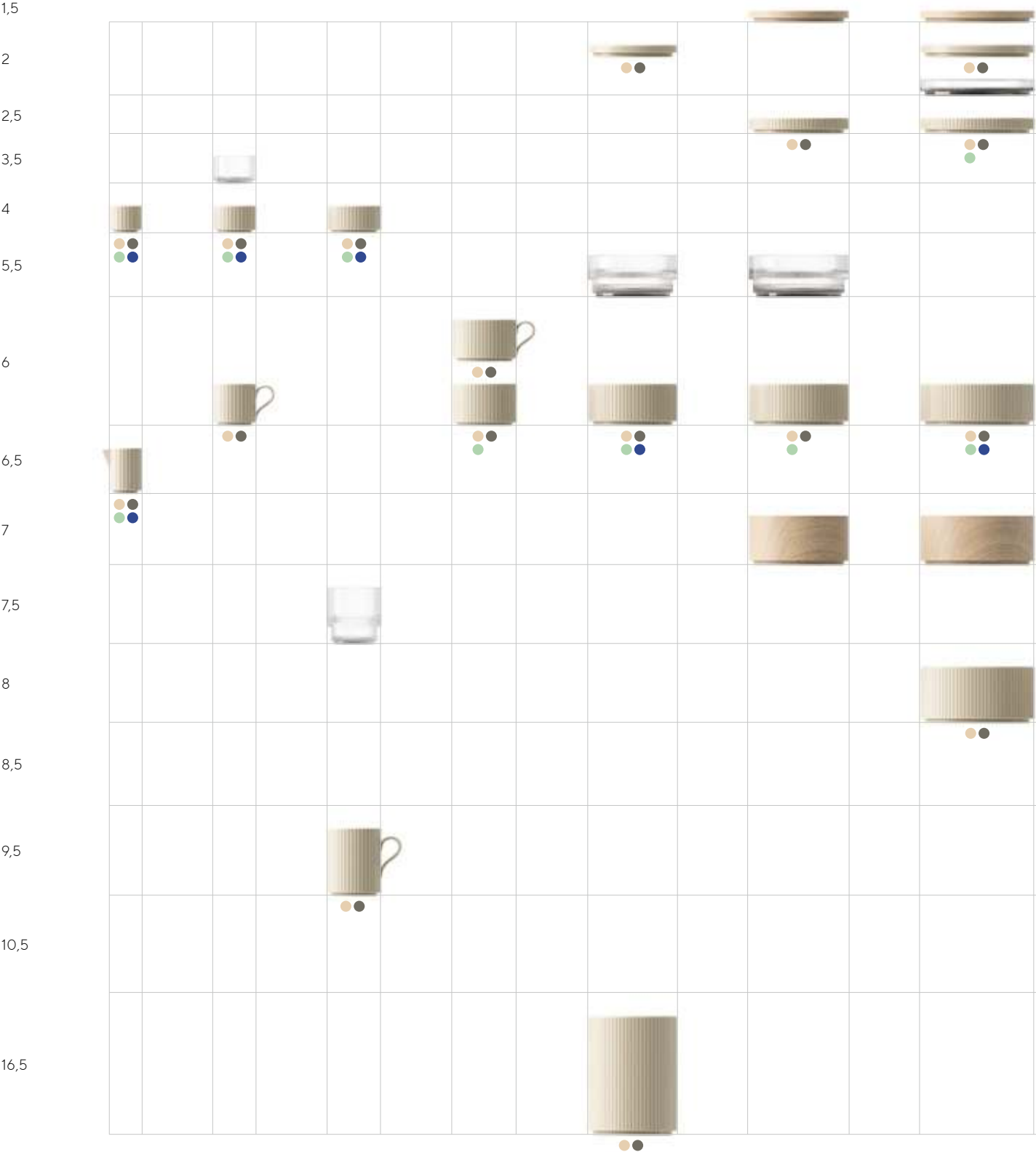

20\*\*

23\*

26\*\*

32

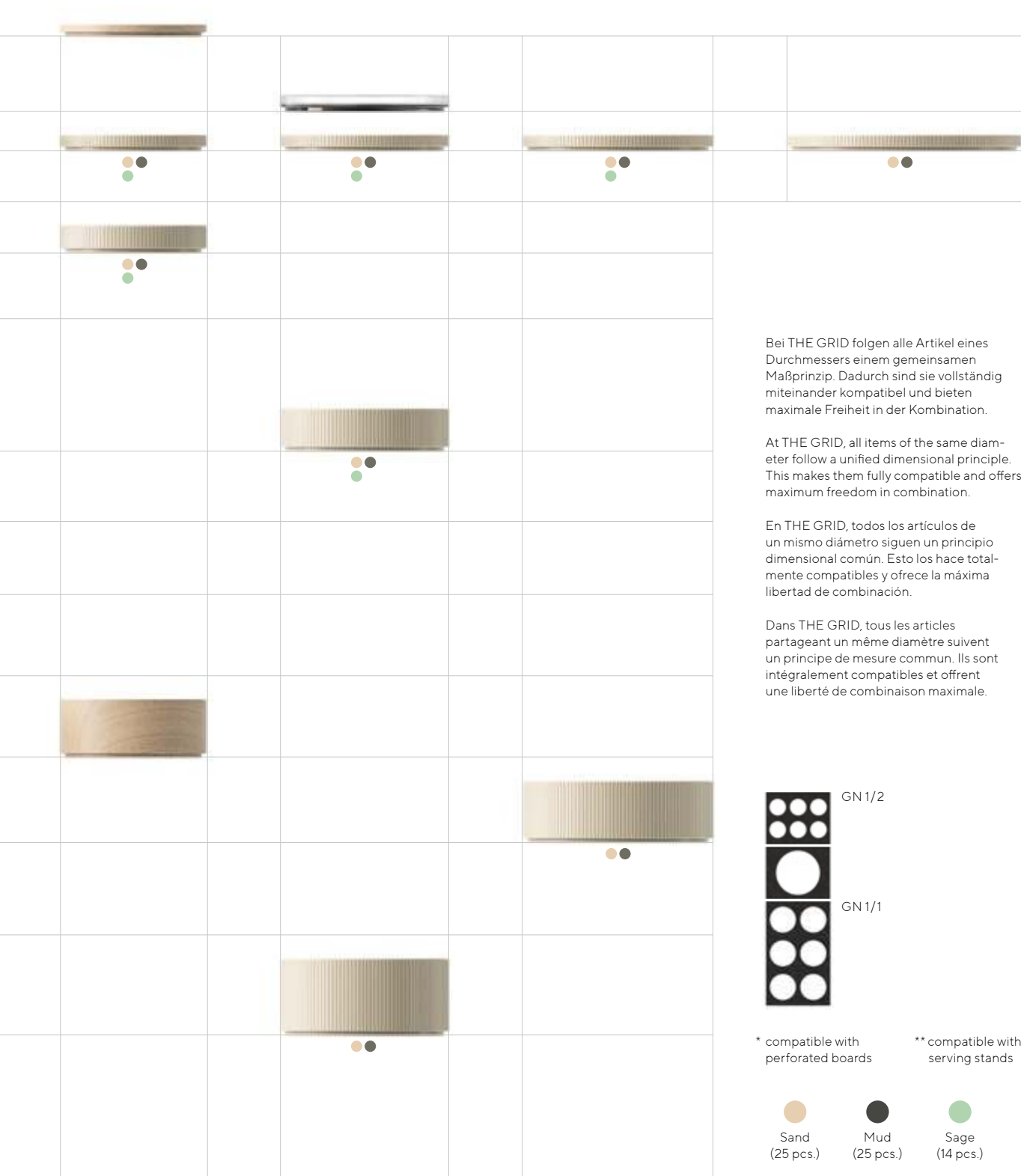

Bei THE GRID folgen alle Artikel eines Durchmessers einem gemeinsamen Maßprinzip. Dadurch sind sie vollständig miteinander kompatibel und bieten maximale Freiheit in der Kombination.

At THE GRID, all items of the same diameter follow a unified dimensional principle. This makes them fully compatible and offers maximum freedom in combination.

En THE GRID, todos los artículos de un mismo diámetro siguen un principio dimensional común. Esto los hace totalmente compatibles y ofrece la máxima libertad de combinación.

Dans THE GRID, tous les articles partageant un même diamètre suivent un principe de mesure commun. Ils sont intégralement compatibles et offrent une liberté de combinaison maximale.

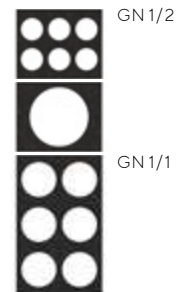

\* compatible with perforated boards

\*\* compatible with serving stands

 Sand (25 pcs.)

 Mud (25 pcs.)

 Sage (14 pcs.)

 Marine (6 pcs.)

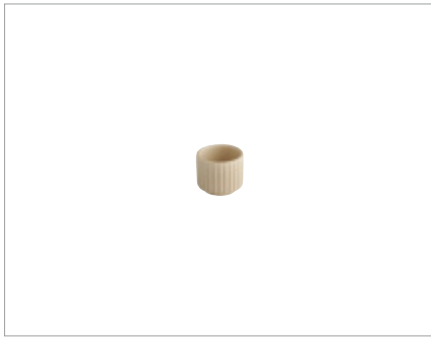

Schale „THE GRID“

bowl  
cuenco  
bol



	Ø cm	cm	ltr.	VE / unit
19020	4,5	4,0	0,025	12



Schale „THE GRID“

bowl  
cuenco  
bol



	Ø cm	cm	ltr.	VE / unit
19022	6,0	4,0	0,045	12



Schale „THE GRID“

bowl  
cuenco  
bol



	Ø cm	cm	ltr.	VE / unit
19024	7,5	4,0	0,070	6

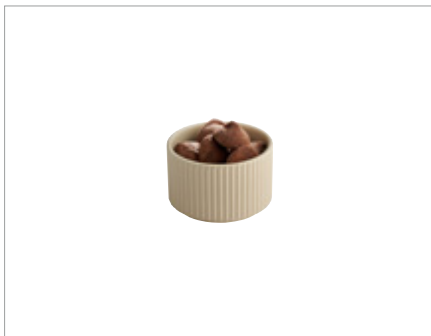

Schale „THE GRID“

bowl  
cuenco  
bol



	Ø cm	cm	ltr.	VE / unit
19027	9,0	6,0	0,20	6



Schale „THE GRID“

bowl  
cuenco  
bol



	Ø cm	cm	ltr.	VE / unit
19029	12,5	6,0	0,35	6
19030	12,5	16,5	1,30	-





**Teller / Schale „THE GRID“**

plate / bowl  
plato / cuenco  
assiette / bol



	Ø cm	cm	ltr.	VE / unit
19031	14,0	2,5	-	6
19032	14,0	6,0	0,45	6



**Teller / Schale „THE GRID“**

plate / bowl  
plato / cuenco  
assiette / bol



	Ø cm	cm	ltr.	VE / unit
19034	16,0	2,5	-	6
19035	16,0	6,0	0,55	6
19036	16,0	8,0	1,60	6



**Teller / Schale „THE GRID“**

plate / bowl  
plato / cuenco  
assiette / bol



	Ø cm	cm	ltr.	VE / unit
19037	20,0	2,5	-	6
19038	20,0	4,0	0,45	3



Teller / Schale „THE GRID“

plate / bowl  
plato / cuenco  
assiette / bol



	Ø cm	cm	ltr.	VE / unit
19039	23,0	2,5	-	3
19040	23,0	6,0	1,30	3
19041	23,0	10,5	2,50	-



Teller / Schale „THE GRID“

plate / bowl  
plato / cuenco  
assiette / bol



	Ø cm	cm	ltr.	VE / unit
19042	26,0	2,5	-	3
19043	26,0	8,5	2,50	-



Teller „THE GRID“

plate  
plato  
assiette



	Ø cm	cm	VE / unit
19044	32,0	2,5	-



**Gießer „THE GRID“**

pouyer  
vertedor  
pichet



	Ø cm	cm	ltr.	VE / unit
19021	4,5	6,5	0,04	6



**Espressotasse „THE GRID“**

espresso cup  
taza de espresso  
tasse à espresso



	Ø cm	cm	ltr.	VE / unit
19023	6,0	6,0	0,08	6

**Untertasse „THE GRID“**

saucer  
plattillo  
soucoupe



	Ø cm	cm	VE / unit
19028	12,5	2,0	6



**Kaffeebecher „THE GRID“**

coffee mug  
taza de café  
tasse à café



	Ø cm	cm	ltr.	VE / unit
19025	7,5	9,5	0,24	6

**Untertasse „THE GRID“**

saucer  
plattillo  
soucoupe



	Ø cm	cm	VE / unit
19033	16,0	2,0	6



**Cappuccinotasse „THE GRID“**

cappuccino cup  
taza de cappuccino  
tasse à cappuccino



	Ø cm	cm	ltr.	VE / unit
19026	9,0	6,0	0,20	6

**Untertasse „THE GRID“**

saucer  
plattillo  
soucoupe



	Ø cm	cm	VE / unit
19033	16,0	2,0	6

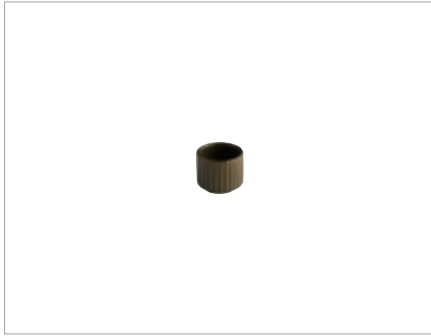

Schale „THE GRID“

bowl  
cuenco  
bol



	Ø cm	cm	ltr.	VE / unit
19060	4,5	4,0	0,025	12



Schale „THE GRID“

bowl  
cuenco  
bol



	Ø cm	cm	ltr.	VE / unit
19062	6,0	4,0	0,045	12



Schale „THE GRID“

bowl  
cuenco  
bol



	Ø cm	cm	ltr.	VE / unit
19064	7,5	4,0	0,070	6

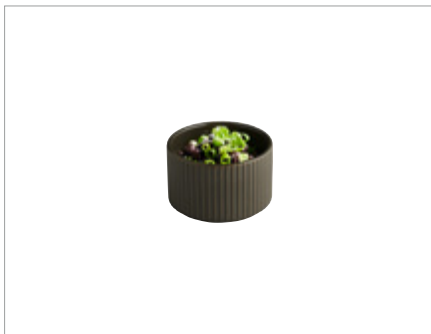

Schale „THE GRID“

bowl  
cuenco  
bol



	Ø cm	cm	ltr.	VE / unit
19067	9,0	6,0	0,20	6



Schale „THE GRID“

bowl  
cuenco  
bol



	Ø cm	cm	ltr.	VE / unit
19069	12,5	6,0	0,35	6
19070	12,5	16,5	1,30	-





**Teller / Schale „THE GRID“**

plate / bowl  
plato / cuenco  
assiette / bol



	Ø cm	cm	ltr.	VE / unit
19071	14,0	2,5	-	6
19072	14,0	6,0	0,45	6



**Teller / Schale „THE GRID“**

plate / bowl  
plato / cuenco  
assiette / bol



	Ø cm	cm	ltr.	VE / unit
19074	16,0	2,5	-	6
19075	16,0	6,0	0,55	6
19076	16,0	8,0	1,60	6



**Teller / Schale „THE GRID“**

plate / bowl  
plato / cuenco  
assiette / bol



	Ø cm	cm	ltr.	VE / unit
19077	20,0	2,5	-	6
19078	20,0	4,0	0,45	3



Teller / Schale „THE GRID“

plate / bowl  
plato / cuenco  
assiette / bol



	Ø cm	cm	ltr.	VE / unit
19079	23,0	2,5	-	3
19080	23,0	6,0	1,30	3
19081	23,0	10,5	2,50	-



Teller / Schale „THE GRID“

plate / bowl  
plato / cuenco  
assiette / bol



	Ø cm	cm	ltr.	VE / unit
19082	26,0	2,5	-	3
19083	26,0	8,5	2,50	-



Teller „THE GRID“

plate  
plato  
assiette



	Ø cm	cm	VE / unit
19084	32,0	2,5	-



**Gießer „THE GRID“**

pouyer  
vertedor  
pichet



	Ø cm	cm	ltr.	VE / unit
19061	4,5	6,5	0,04	6



**Espressotasse „THE GRID“**

espresso cup  
taza de espresso  
tasse à espresso



	Ø cm	cm	ltr.	VE / unit
19063	6,0	6,0	0,08	6

**Untertasse „THE GRID“**

saucer  
plattilo  
soucoupe



	Ø cm	cm	VE / unit
19068	12,5	2,0	6



**Kaffeebecher „THE GRID“**

coffee mug  
taza de café  
tasse à café



	Ø cm	cm	ltr.	VE / unit
19065	7,5	9,5	0,24	6

**Untertasse „THE GRID“**

saucer  
plattilo  
soucoupe



	Ø cm	cm	VE / unit
19073	16,0	2,0	6



**Cappuccinotasse „THE GRID“**

cappuccino cup  
taza de cappuccino  
tasse à cappuccino



	Ø cm	cm	ltr.	VE / unit
19066	9,0	6,0	0,20	6

**Untertasse „THE GRID“**

saucer  
plattilo  
soucoupe



	Ø cm	cm	VE / unit
19073	16,0	2,0	6



Schale „THE GRID“

bowl  
cuenco  
bol



	Ø cm	cm	ltr.	VE / unit
19100	4,5	4,0	0,025	12



Gießer „THE GRID“

pourer  
vertedor  
pichet



	Ø cm	cm	ltr.	VE / unit
19101	4,5	6,5	0,04	6



Schale „THE GRID“

bowl  
cuenco  
bol



	Ø cm	cm	ltr.	VE / unit
19102	6,0	4,0	0,045	12

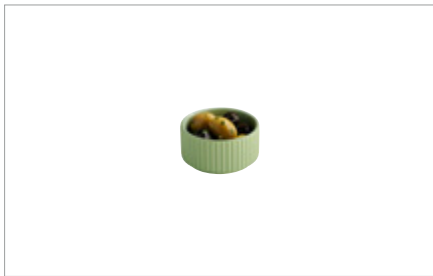

Schale „THE GRID“

bowl  
cuenco  
bol



	Ø cm	cm	ltr.	VE / unit
19104	7,5	4,0	0,070	6



Schale „THE GRID“

bowl  
cuenco  
bol



	Ø cm	cm	ltr.	VE / unit
19107	9,0	6,0	0,20	6



Schale „THE GRID“

bowl  
cuenco  
bol



	Ø cm	cm	ltr.	VE / unit
19109	12,5	6,0	0,35	6



Schale „THE GRID“

bowl  
cuenco  
bol



	Ø cm	cm	ltr.	VE / unit
19112	14,0	6,0	0,45	6



**Teller / Schale „THE GRID“**

plate / bowl  
plato / cuenco  
assiette / bol



	Ø cm	cm	ltr.	VE / unit
19114	16,0	2,5	-	6
19115	16,0	6,0	0,55	6



**Teller / Schale „THE GRID“**

plate / bowl  
plato / cuenco  
assiette / bol



	Ø cm	cm	ltr.	VE / unit
19117	20,0	2,5	-	6
19118	20,0	4,0	0,45	3



**Teller / Schale „THE GRID“**

plate / bowl  
plato / cuenco  
assiette / bol



	Ø cm	cm	ltr.	VE / unit
19119	23,0	2,5	-	3
19120	23,0	6,0	1,30	3



**Teller „THE GRID“**

plate bowl  
plato cuenco  
assiette bol



	Ø cm	cm	VE / unit
19122	26,0	2,5	3



Schale „THE GRID“

bowl  
cuenco  
bol



	Ø cm	cm	ltr.	VE / unit
19140	4,5	4,0	0,025	12

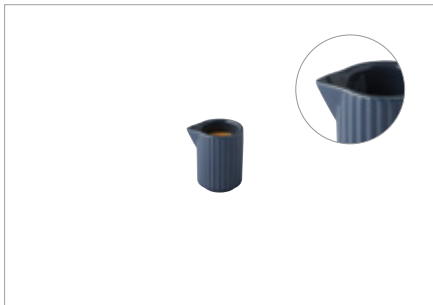

Gießer „THE GRID“

pourer  
vertedor  
pichet



	Ø cm	cm	ltr.	VE / unit
19141	4,5	6,5	0,04	6



Schale „THE GRID“

bowl  
cuenco  
bol



	Ø cm	cm	ltr.	VE / unit
19142	6,0	4,0	0,045	12



Schale „THE GRID“

bowl  
cuenco  
bol



	Ø cm	cm	ltr.	VE / unit
19144	7,5	4,0	0,070	6



Schale „THE GRID“

bowl  
cuenco  
bol



	Ø cm	cm	ltr.	VE / unit
19149	12,5	6,0	0,35	6

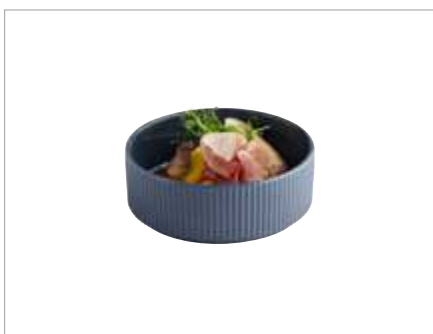

Schale „THE GRID“

bowl  
cuenco  
bol



	Ø cm	cm	ltr.	VE / unit
19155	16,0	6,0	0,55	6



Schale „THE GRID“

bowl  
cuenco  
bol

GLASS

	Ø cm	cm	ltr.	VE / unit
19000	6,0	3,5	0,045	12



Trinkglas „THE GRID“

drinking glass  
vaso de agua  
verre à boire

GLASS

	Ø cm	cm	ltr.	VE / unit
19001	7,5	7,5	0,175	6



Schale „THE GRID“

bowl  
cuenco  
bol

GLASS

	Ø cm	cm	ltr.	VE / unit
19002	12,5	5,5	0,35	12



Schale „THE GRID“

bowl  
cuenco  
bol

GLASS

	Ø cm	cm	ltr.	VE / unit
19003	14,0	5,5	0,45	6



Teller „THE GRID“

plate  
plato  
assiette

GLASS

	Ø cm	cm	VE / unit
19004	16,0	2,0	6



Teller „THE GRID“

plate  
plato  
assiette

GLASS

	Ø cm	cm	VE / unit
19005	23,0	2,0	6



**Teller / Schale „THE GRID“**  
 plate / bowl  
 plato / cuenco  
 assiette / bol

**OAK WOOD**

Eichenholz (geölt) / oak wood (oiled) / madera de roble (aceitada) / chêne (huilé)

	Ø cm	cm	ltr.
19010	14,0	1,5	-
19011	14,0	7,0	0,55



**Teller / Schale „THE GRID“**  
 plate / bowl  
 plato / cuenco  
 assiette / bol

**OAK WOOD**

Eichenholz (geölt) / oak wood (oiled) / madera de roble (aceitada) / chêne (huilé)

	Ø cm	cm	ltr.
19012	16,0	1,5	-
19013	16,0	7,0	0,72



**Teller / Schale „THE GRID“**  
 plate / bowl  
 plato / cuenco  
 assiette / bol

**OAK WOOD**

Eichenholz (geölt) / oak wood (oiled) / madera de roble (aceitada) / chêne (huilé)

	Ø cm	cm	ltr.
19014	20,0	1,5	-
19015	20,0	8,0	1,5

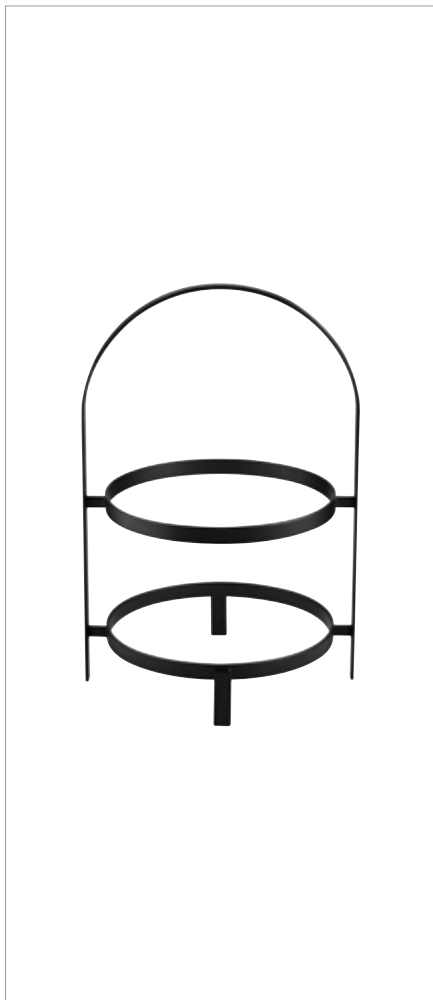

**Serviergestell „THE GRID“**

serving stand  
soporte platos  
présentoir à assiettes

**kompatibel mit allen Artikeln der Serie „THE GRID“ mit Ø 20 cm**

compatible with all items in the „THE GRID“ series with a Ø 20 cm

compatible con todos los artículos de la serie „THE GRID“ con un Ø de 20 cm

compatible avec tous les articles de la série „THE GRID“ d'un Ø de 20 cm

	cm	cm
19180	23,5 x 20,5	35,5

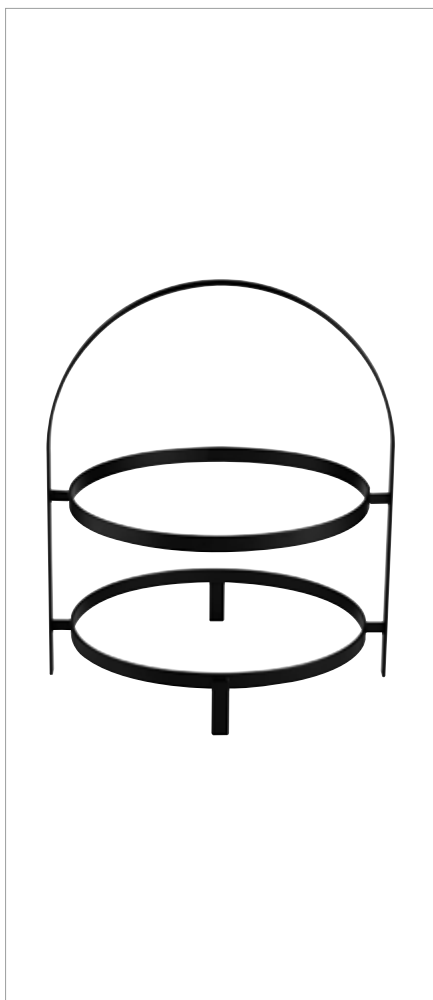

**Serviergestell „THE GRID“**

serving stand  
soporte platos  
présentoir à assiettes

**kompatibel mit allen Artikeln der Serie „THE GRID“ mit Ø 26 cm**

compatible with all items in the „THE GRID“ series with a Ø 26 cm

compatible con todos los artículos de la serie „THE GRID“ con un Ø de 26 cm

compatible avec tous les articles de la série „THE GRID“ d'un Ø de 26 cm

	cm	cm
19181	29,5 x 26,5	35,5





**NEW** THE GRID COOLING



**GN 1/1 Naturschieferplatte**

GN 1/1 natural slate tray  
GN 1/1 bandeja de pizarra natural  
GN 1/1 plat ardoise naturelle



**kompatibel mit allen Artikeln der Serie „THE GRID“ mit Ø 14 cm**

compatible with all items in the „THE GRID“ series with a Ø 14 cm

compatible con todos los artículos de la serie „THE GRID“ con un Ø de 14 cm

compatible avec tous les articles de la série „THE GRID“ d'un Ø de 14 cm

	cm	✦ mm	GN	fits to
19185	53,0 x 32,5	6-9	1/1	VALO GN 1/1



**GN 1/2 Naturschieferplatte**

GN 1/2 natural slate tray  
GN 1/2 bandeja de pizarra natural  
GN 1/2 plat ardoise naturelle



**kompatibel mit allen Artikeln der Serie „THE GRID“ mit Ø 23 cm**

compatible with all items in the „THE GRID“ series with a Ø 23 cm

compatible con todos los artículos de la serie „THE GRID“ con un Ø de 23 cm

compatible avec tous les articles de la série „THE GRID“ d'un Ø de 23 cm

	cm	✦ mm	GN	fits to
19186	32,5 x 26,5	6-9	1/2	VALO GN 1/2, GN 1/1





**GN 1/2 Naturschieferplatte**

GN 1/2 natural slate tray  
GN 1/2 bandeja de pizarra natural  
GN 1/2 plat ardoise naturelle



kompatibel mit allen Artikeln der Serie „THE GRID“ mit Ø 9 cm

compatible with all items in the „THE GRID“ series with a Ø 9 cm

compatible con todos los artículos de la serie „THE GRID“ con un Ø de 9 cm

compatible avec tous les articles de la série „THE GRID“ d'un Ø de 9 cm

	cm	✂ mm	GN	fits to
19187	32,5 x 26,5	6-9	1/2	VALO GN 1/2, GN 1/1



**Kühlakku**

cooler  
acumulador de frío  
accumulateur de froid



	cm	cm	fits to
10791	25 x 19	2,5	14078



**GN 1/2 Einsatz „VALO“**

GN 1/2 insert  
GN 1/2 inserto  
GN 1/2 insert



	cm	cm	fits to
14078	30 x 24	4	VALO GN 1/2, GN 1/1 with height: 8,5 cm

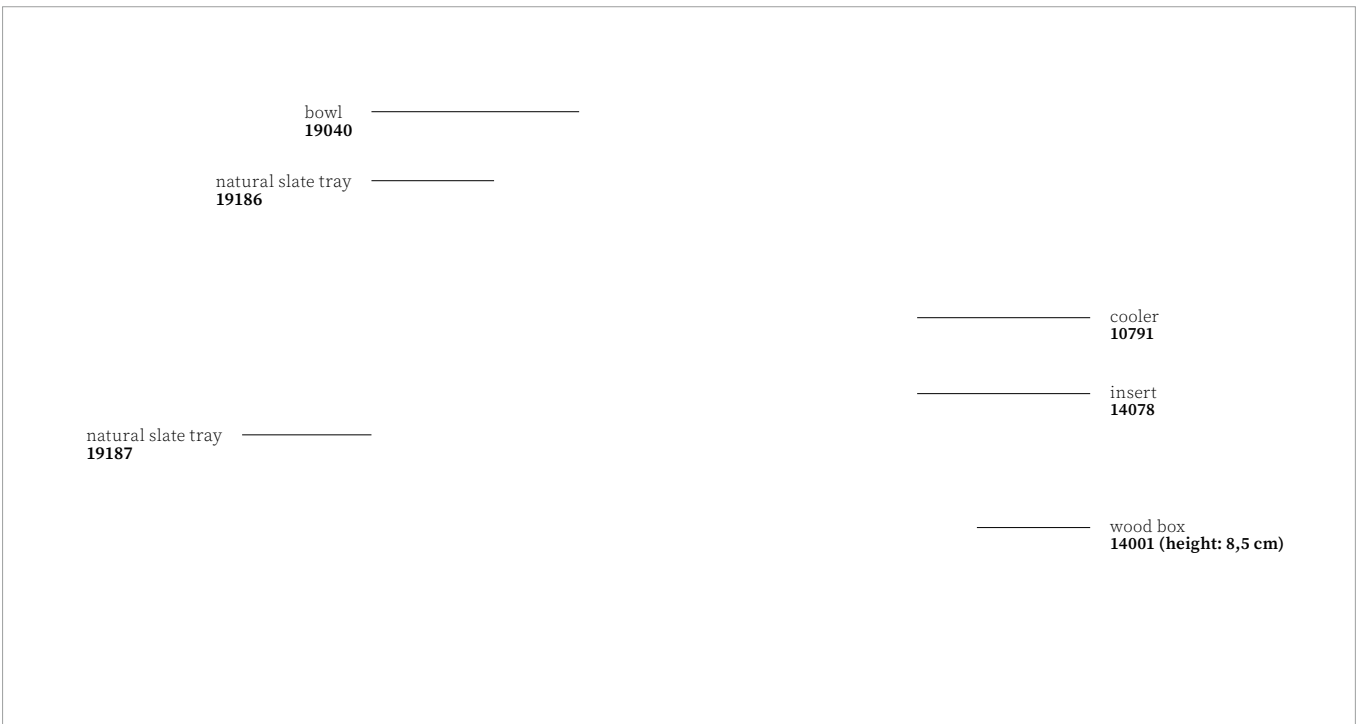

## THE GRID x VALO



### GN 1/1 Holzbox „VALO“

GN 1/1 woodbox  
GN 1/1 caja madera  
GN 1/1 base bois

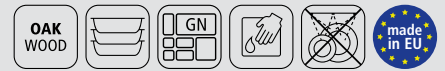

	cm	cm	GN	Farbe / colour
14000	53 x 32,5	4,5	1/1	(oiled)
14001	53 x 32,5	8,5	1/1	(oiled)
14002	53 x 32,5	16,5	1/1	(oiled)

Kompatibel mit den Naturschieferplatten Nr. 19185, 19186 und 19187.

Die Kombination mit dem Kühlsystem (Einsatz Nr. 14078 + Kühlakku Nr. 10791) passt nur in VALO-Boxen mit der Höhe 8,5 cm.

Compatible with natural slate plates no. 19185, 19186 and 19187.

The combination with the cooling system (insert no. 14078 + cooling pack no. 10791) only fits VALO boxes with height 8,5 cm.



### GN 1/1 Holzbox „VALO“

GN 1/1 woodbox  
GN 1/1 caja madera  
GN 1/1 base bois



	cm	cm	GN	Farbe / colour
14100	53 x 32,5	4,5	1/1	(lacquered)
14101	53 x 32,5	8,5	1/1	(lacquered)
14102	53 x 32,5	16,5	1/1	(lacquered)

Kompatibel mit den Naturschieferplatten Nr. 19185, 19186 und 19187.

Die Kombination mit dem Kühlsystem (Einsatz Nr. 14078 + Kühlakku Nr. 10791) passt nur in VALO-Boxen mit der Höhe 8,5 cm.

Compatible with natural slate plates no. 19185, 19186 and 19187.

The combination with the cooling system (insert no. 14078 + cooling pack no. 10791) only fits VALO boxes with height 8,5 cm.





GN 1/2 Holzbox „VALO“

GN 1/2 woodbox  
GN 1/2 caja madera  
GN 1/2 base bois

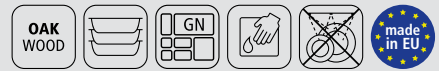

	cm	cm	GN	Farbe / colour
14003	32,5 x 26,5	4,5	1/2	(oiled)
14004	32,5 x 26,5	8,5	1/2	(oiled)
14005	32,5 x 26,5	16,5	1/2	(oiled)

Kompatibel mit den Naturschieferplatten Nr. 19186 und 19187.  
Die Kombination mit dem Kühlsystem (Einsatz Nr. 14078 + Kühlakku Nr. 10791)  
passt nur in VALO-Boxen mit der Höhe 8,5 cm.

Compatible with natural slate plates no. 19186 and 19187.  
The combination with the cooling system (insert no. 14078 + cooling pack no. 10791)  
only fits VALO boxes with height 8,5 cm.



GN 1/2 Holzbox „VALO“

GN 1/2 woodbox  
GN 1/2 caja madera  
GN 1/2 base bois



	cm	cm	GN	Farbe / colour
14103	32,5 x 26,5	4,5	1/2	(lacquered)
14104	32,5 x 26,5	8,5	1/2	(lacquered)
14105	32,5 x 26,5	16,5	1/2	(lacquered)

Kompatibel mit den Naturschieferplatten Nr. 19186 und 19187.  
Die Kombination mit dem Kühlsystem (Einsatz Nr. 14078 + Kühlakku Nr. 10791)  
passt nur in VALO-Boxen mit der Höhe 8,5 cm.

Compatible with natural slate plates no. 19186 and 19187.  
The combination with the cooling system (insert no. 14078 + cooling pack no. 10791)  
only fits VALO boxes with height 8,5 cm.



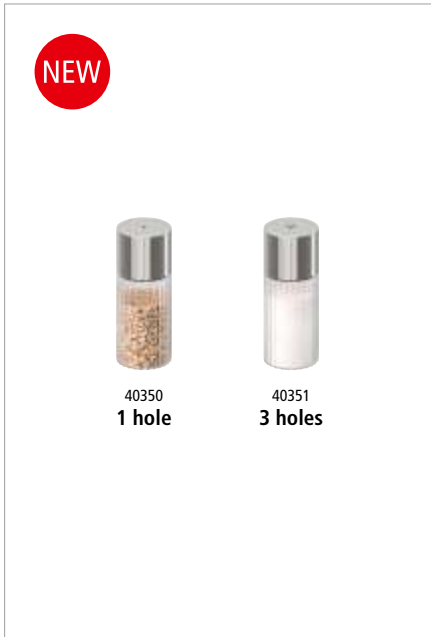

**Salz- / Pfefferstreuer „THE GRID“**

salt / pepper shaker  
salero / pimentero  
salière / poivrière



	Ø cm	cm	ltr.	
40350	3,5	9	0,04	1 hole – Ø 2 mm
40351	3,5	9	0,04	3 holes – Ø 2 mm



**Essig- & Öl-Flasche „THE GRID“**

oil- and vinegar bottle  
botella de aceite y vinagre  
bouteille d'huile et vinaigre



mit Deckel und integriertem Dosierrohr für ein präzises und kontrolliertes Ausgießen

with lid and integrated measuring tube for precise and controlled pouring

con tapa y tubo dosificador integrado para un vertido preciso y controlado

avec couvercle et tube doseur intégré pour un versement précis et contrôlé

	Ø cm	cm	ltr.
40352	6	15,5	0,2



**Zuckerdosierer „THE GRID“**

sugar dispenser  
azucarero  
sucrier



mit integriertem Dosierrohr für ein präzises und kontrolliertes Portionieren

with integrated measuring tube, for precise and controlled portioning

con tubo dosificador integrado para un dosificado preciso y controlado

avec tube doseur intégré pour un dosage précis et contrôlé

	Ø cm	cm	ltr.
40353	6	17	0,2





Allzweckgießer „THE GRID“

pourer  
bote vertedor universal  
pot verseur universel  
ideal für Kaffeesahne und Milch  
ideal for cream and milk  
ideal para crema y leche  
idéal pour la crème et le lait



	Ø cm	cm	ltr.
40354	6	15,5	0,2



Menage „THE GRID“

menage  
menage  
ménage



Metall matt-schwarz, perfekt zur Präsentation von Essig & Öl sowie Milch & Zucker  
metal matte black, perfect for presenting vinegar & oil as well as milk & sugar  
metal negro mate, perfecto para presentar vinagre y aceite, así como leche y azúcar  
métal noir mat, parfait pour présenter le vinaigre et l'huile ainsi que le lait et le sucre

	cm	cm	fits to
40358	14,5 x 7	30	40352, 40353, 40354



Menage „THE GRID“

menage  
menage  
ménage



Metall matt-schwarz, perfekt zur Präsentation von Essig & Öl, Milch & Zucker sowie Gewürzen  
metal matte black, perfect for presenting vinegar & oil, milk & sugar, as well as spices  
metal negro mate, perfecto para presentar vinagre y aceite, leche y azúcar, así como especias  
métal noir mat, parfait pour présenter le vinaigre et l'huile, le lait et le sucre, ainsi que des épices

	cm	cm	fits to
40359	14,5 x 10,5	30	40350, 40351, 40352, 40353, 40354



# PERFECTO



## Buffetständer „PERFECTO“

buffet stand  
soporte para buffet  
présentoir buffet



Gestell aus Metall mit schwarzer Antirutschbeschichtung  
metal frame with black anti-slide coating  
soporte de metal con revestimiento antideslizante negro  
structure en métal avec revêtement antidérapant noir

	cm	cm	fits to
33304	23 x 19	40,5	33302, 33303
33308 <small>NEW</small>	23 x 19	59,5	33302, 33303



## Buffetbrett „PERFECTO“

buffet board  
tabla de buffet  
planche de buffet



	cm	cm	fits to
33302	20 x 20	2	33304, 33308
33303	80 x 20	2	33304, 33308

3 tlg.  
3 pcs.



2-stufige Etagère „PERFECTO SMALL“

2-tier tray  
bandeja dos alturas  
étagère carré 2 hauteurs



3-teiliges Set, bestehend aus:

- 1 Buffetständer aus Metall mit schwarzer Antirutschbeschichtung, 23 x 19 cm, H: 40,5 cm
- 2 Bretter aus Eichenholz, geölt, 20 x 20 cm, H: 2 cm

3 pcs., consisting of:

- 1 buffet stand, metal with black anti-slide coating, 23 x 19 cm, h: 40,5 cm
- 2 boards, oiled oak, 20 x 20 cm, h: 2 cm

set de 3, compuesto por:

- 1 soporte para buffet, metal con revestimiento antideslizante negro, 23 x 19 cm, a: 40,5 cm
- 2 tablas de roble, aceitadas, 20 x 20 cm, a: 2 cm

set de 3, composé de :

- 1 présentoir buffet, métal avec revêtement antidérapant noir, 23 x 19 cm, h: 40,5 cm
- 2 planches en bois de chêne, huilées, 20 x 20 cm, h: 2 cm

	cm	cm
33300	23 x 20	40,5

4 tlg.  
4 pcs.



2-stufige Etagère „PERFECTO LARGE“

2-tier tray  
bandeja dos alturas  
étagère carré 2 hauteurs



4-teiliges Set, bestehend aus:

- 2 Buffetständer aus Metall mit schwarzer Antirutschbeschichtung, 23 x 19 cm, H: 40,5 cm
- 2 Bretter aus Eichenholz, geölt, 80 x 20 cm, H: 2 cm

4 pcs., consisting of:

- 2 buffet stands, metal with black anti-slide coating, 23 x 19 cm, h: 40,5 cm
- 2 boards, oiled oak, 80 x 20 cm, h: 2 cm

set de 4, compuesto por:

- 2 soportes para buffet, metal con revestimiento antideslizante negro, 23 x 19 cm, a: 40,5 cm
- 2 tablas de roble, aceitadas, 80 x 20 cm, a: 2 cm

set de 4, composé de :

- 2 présentoirs buffet, métal avec revêtement antidérapant noir, 23 x 19 cm, h: 40,5 cm
- 2 planches en bois de chêne, huilées, 80 x 20 cm, h: 2 cm

	cm	cm
33301	80 x 23	40,5





**Dosierspender „DISPENSA“**

dosing dispenser  
dosificador  
distributeur de dosage

Behälter aus Glas, ideal zum Dosieren von Marmelade, Joghurt und Saucen (ohne Stücke / Fruchtfleisch)

glass container, ideal for dosing jam, yoghurt and sauces (without pieces / pulp)

recipiente de cristal, ideal para dosificar mermelada, yogur y salsas (sin trozos / pulpa)

réceptien en verre, idéal pour doser la confiture, le yaourt et les sauces (sans morceaux / pulpe)

	Ø cm	cm	ltr.
93286	10	27	1,0
93291	13	27	1,7



Hubvolumen 15 ml  
stroke volume 15 ml



**Dosierspender „DISPENSA“**

dosing dispenser  
dosificador  
distributeur de dosage

Behälter aus Glas, ideal zum Dosieren von Marmelade, Joghurt und Saucen (ohne Stücke / Fruchtfleisch)

glass container, ideal for dosing jam, yoghurt and sauces (without pieces / pulp)

recipiente de cristal, ideal para dosificar mermelada, yogur y salsas (sin trozos / pulpa)

réceptien en verre, idéal pour doser la confiture, le yaourt et les sauces (sans morceaux / pulpe)

	Ø cm	cm	ltr.
93285 <b>NEW</b>	10	27	1,0
93290	13	27	1,7



Hubvolumen 15 ml  
stroke volume 15 ml





33249



33311



33251



33313

### Buffetständer „MULTI“











buffet stand  
soporte para buffet  
présentoir buffet

die Kombination verschiedener Höhen erzeugt eine ansprechende Tiefe auf dem Buffet

the combination of different heights creates an appealing depth on the buffet

la combinación de diferentes alturas crea una profundidad atractiva en el buffet

la combinaison de différentes hauteurs crée une profondeur attrayante sur le buffet

	cm	cm	Farbe / colour	
33249	18 x 18	5		black
33250	18 x 18	8		black
33251	18 x 18	10		black
33252	18 x 18	20		black
33310 	18 x 18	5		gold
33311 	18 x 18	8		gold
33312 	18 x 18	10		gold
33313 	18 x 18	20		gold



mit Antirutschbeschichtung  
with anti-slide coating



33269



33271

### Buffetständer „MULTI“



buffet stand  
soporte para buffet  
présentoir buffet

die Kombination verschiedener Höhen erzeugt eine ansprechende Tiefe auf dem Buffet

the combination of different heights creates an appealing depth on the buffet

la combinación de diferentes alturas crea una profundidad atractiva en el buffet

la combinaison de différentes hauteurs crée une profondeur attrayante sur le buffet

	Ø cm	cm	Farbe / colour	
33269	15,5 / 18	8		black
33270	15,5 / 18	10		black
33271	15,5 / 18	18		black



mit Antirutschbeschichtung  
with anti-slide coating

# MANGO



01050

01053

01056

01057

## Schale „MANGO“

bowl  
cuenco  
bol

MANGO  
WOOD

EACH  
PIECE  
UNIQUE

MAX  
40°C

handgefertigte Schale mit edler, innenliegender Epoxidharzbeschichtung

handmade bowl with a refined inner epoxy resin coating

cuenco hecho a mano con un elegante revestimiento interior de resina epoxi

bol fabriqué à la main avec un élégant revêtement intérieur en résine époxy

	Ø cm	cm	ltr.
01050	20	7,5	0,8
01053	24	7,5	1,1
01056	30	10,5	3,0
01057	37	9,0	4,0



## Tablett / Teller „MANGO“

tray / plate  
bandeja / plato  
plateau / assiette

MANGO  
WOOD

EACH  
PIECE  
UNIQUE

MAX  
40°C

handgefertigter Teller mit edler, innenliegender Epoxidharzbeschichtung

handmade plate with a refined inner epoxy resin coating

plato hecho a mano con un elegante revestimiento interior de resina epoxi

assiette fabriquée à la main avec un élégant revêtement intérieur en résine époxy

	Ø cm	cm
01058	35,5	2,5

NEW



01060



01062

## Schale „MANGO“

bowl  
cuenco  
bolMANGO  
WOODEACH  
PIECE  
UNIQUEMAX  
40°C

handgefertigte Schale mit edler, innenliegender Epoxidharzbeschichtung

handmade bowl with a refined inner epoxy resin coating

cuenco hecho a mano con un elegante revestimiento interior de resina epoxi

bol fabriqué à la main avec un élégant revêtement intérieur en résine époxy

	Ø cm	cm	ltr.
01060	20	7,5	0,8
01062	30	10,5	3,0



01051



01054

## Schale „MANGO“

bowl  
cuenco  
bolMANGO  
WOODEACH  
PIECE  
UNIQUEMAX  
40°C

handgefertigte Schale mit edler, innenliegender Epoxidharzbeschichtung

handmade bowl with a refined inner epoxy resin coating

cuenco hecho a mano con un elegante revestimiento interior de resina epoxi

bol fabriqué à la main avec un élégant revêtement intérieur en résine époxy

	Ø cm	cm	ltr.
01051	24	7,5	1,1
01054	30	10,5	3,0

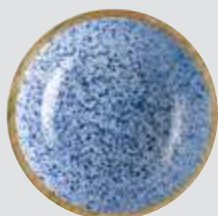

# TERRAZZO



NEW



30080



30081



30082

## Schale „TERRAZZO“

bowl  
cuenco  
bol

**Terrazooptik**

terrazzo look  
aspecto terrazo  
optique terrazzo

	Ø cm	cm	ltr.
30080	22,0	6,0 / 10,5	1,1
30081	26,0	7,5 / 13,0	1,7
30082	29,5	8,5 / 14,5	2,5

Farb- und Strukturabweichungen möglich  
colour and texture variations possible

NEW

**Dose, 2er Set „TERRAZZO“**

container, 2 pcs.  
recipiente, set de 2  
boîte, set de 2

**ideal zum Servieren von Aufstrichen, Butter, Gewürzen oder kleinen Delikatessen**

ideal for serving spreads, butter, spices, or small delicacies

ideal para servir untables, mantequilla, especias o pequeñas delicias

idéal pour servir des tartinades, du beurre, des épices ou de petites gourmandises

	Ø cm	cm	ml
15917	6	5	40

Farb- und Strukturabweichungen möglich  
colour and texture variations possible

**Flaschenkühler „TERRAZZO“**

bottle cooler  
enfriador de botella  
rafraîchisseur de bouteille

**Terrazooptik**

terrazzo look

aspecto terrazo

optique terrazzo

	Ø cm	cm
36150	12,5 / 10	19

Farb- und Strukturabweichungen möglich  
colour and texture variations possible

**Besteckbehälter „TERRAZZO“**

cutlery bin  
recipiente para cubiertos  
récipients pour couverts

**Terrazooptik, mit Abflussloch, Bodeneinlage aus Silikon zum Schonen des Bestecks**

terrazzo look, with drain hole, silicone floor insert for saving the points of knives

aspecto terrazo, con orificio de drenaje, soporte de silicona para proteger las puntas de los cuchillos

optique terrazzo, avec le trou de drainage, insert de silicone pour protéger les pointes des couteaux

	Ø cm	cm
11760	11	13,5

Farb- und Strukturabweichungen möglich  
colour and texture variations possible





Löffel „BULQ“

spoon  
cuchara  
cuillère

18/8  
STAINLESS  
STEEL

die angeschrägte Form sorgt für eine komfortable Entnahme und ein sauberes Servieren  
the bevelled shape ensures easy removal and clean serving  
la forma biselada facilita la extracción y el servicio limpio  
la forme biseautée permet un prélèvement confortable et un service propre

	cm	→ cm	ml	Farbe / colour
75946	8,5 x 8,5	23	120	vintage-look
75947	8,5 x 8,5	23	120	vintage-look gold (PVD)
75948	8,5 x 8,5	23	120	vintage-look copper (PVD)

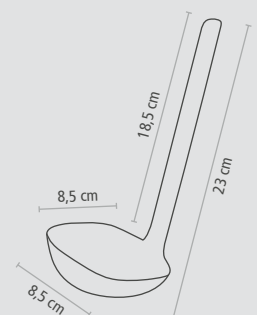



**Löffel, 2er Set „BULQ“**

spoon, set of 2  
cuchara, set de 2  
cuillère, set de 2

**18/8**  
STAINLESS  
STEEL

die angeschrägte Form sorgt für eine komfortable Entnahme und ein sauberes Servieren  
the bevelled shape ensures easy removal and clean serving  
la forma biselada facilita la extracción y el servicio limpio  
la forme biseautée permet un prélèvement confortable et un service propre

	cm	→ cm	ml	Farbe / colour	pcs.
75943	6,5 x 6,5	17,5	60		vintage-look 2
75944	6,5 x 6,5	17,5	60		vintage-look gold (PVD) 2
75945	6,5 x 6,5	17,5	60		vintage-look copper (PVD) 2

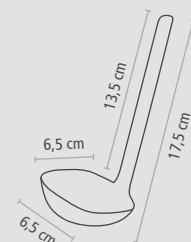

**Löffel, 4er Set „BULQ“**

spoon, set of 4  
cuchara, set de 4  
cuillère, set de 4

**18/8**  
STAINLESS  
STEEL

die angeschrägte Form sorgt für eine komfortable Entnahme und ein sauberes Servieren  
the bevelled shape ensures easy removal and clean serving  
la forma biselada facilita la extracción y el servicio limpio  
la forme biseautée permet un prélèvement confortable et un service propre

	cm	→ cm	ml	Farbe / colour	pcs.
75940	4,5 x 4,5	12,5	20		vintage-look 4
75941	4,5 x 4,5	12,5	20		vintage-look gold (PVD) 4
75942	4,5 x 4,5	12,5	20		vintage-look copper (PVD) 4



# FROSTFIRE

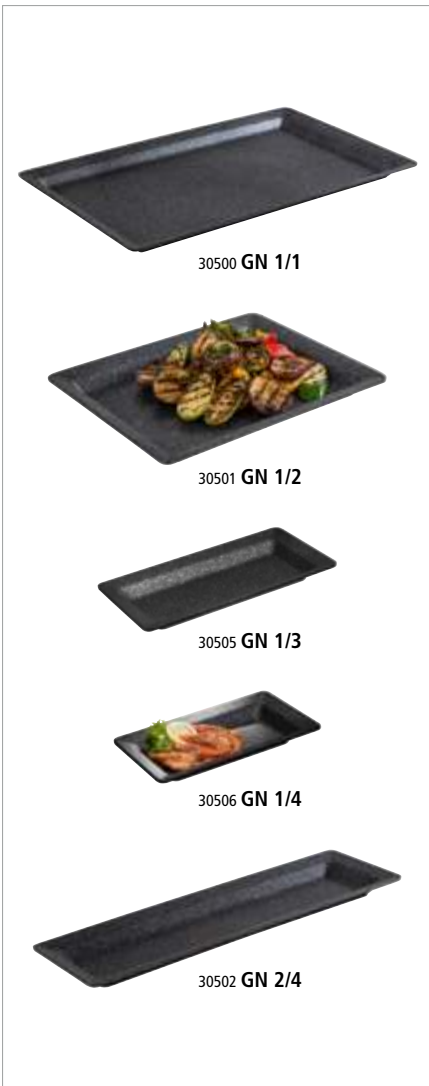

## GN Tablett „FROSTFIRE“

GN tray  
GN bandeja  
GN plateau

Antihafbeschichtung / non stick coating / antiadherente / revêtement anti-adhésif

	cm	cm	GN	Farbe / colour
30500	53,0 x 32,5	3	1/1	black / silver
30501	32,5 x 26,5	3	1/2	black / silver
30505	32,5 x 17,6	3	1/3	black / silver
30506	26,5 x 16,2	3	1/4	black / silver
30502	53,0 x 16,2	3	2/4	black / silver

GN 1/1	GN 1/2	GN 1/3	GN 2/4	GN 1/4
	GN 1/2	GN 1/3		GN 1/4

2 Höhen – 4,5 und 7,5 cm  
2 heights – 4,5 and 7,5 cm



30514  
GN 1/1 – 4,5 cm



30507  
GN 1/2 – 7,5 cm



30511  
GN 1/4 – 4,5 cm



30516  
GN 1/6 – 7,5 cm



30513  
GN 2/4 – 4,5 cm

GN Schale „FROSTFIRE“

GN bowl  
GN cuenco  
GN bol

Antihafbeschichtung / non stick coating / antiadherente / revêtement anti-adhésif

	cm	cm	ltr.	GN	Farbe / colour
30514 <b>NEW</b>	53,0 x 32,5	4,5	4,5	1/1	black / silver
30512 <b>NEW</b>	32,5 x 26,5	4,5	2,4	1/2	black / silver
30511 <b>NEW</b>	26,5 x 16,2	4,5	1,0	1/4	black / silver
30513 <b>NEW</b>	53,0 x 16,2	4,5	2,1	2/4	black / silver

	cm	cm	ltr.	GN	Farbe / colour
30515 <b>NEW</b>	53,0 x 32,5	7,5	9,0	1/1	black / silver
30507	32,5 x 26,5	7,5	4,5	1/2	black / silver
30508	26,5 x 16,2	7,5	2,0	1/4	black / silver
30516 <b>NEW</b>	17,6 x 16,2	7,5	1,3	1/6	black / silver
30509	53,0 x 16,2	7,5	4,25	2/4	black / silver



Schale „FROSTFIRE“

bowl  
cuenco  
bol

Antihafbeschichtung / non stick coating / antiadherente / revêtement anti-adhésif

	Ø cm	cm	ltr.	Farbe / colour
30510	45	10	5,6	black / silver





30517

30503





30504

30518

**Schale „FROSTFIRE“**

bowl  
cuenco  
bol

Antihafbeschichtung / non stick coating / antiadherente / revêtement anti-adhésif

	cm	cm	ltr.	Farbe / colour
30517 <small>NEW</small>	12,5 x 12,5	6,5	0,5	 black / silver
30503	19,0 x 19,0	9,0	1,5	 black / silver
30504	25,0 x 25,0	12,0	3,8	 black / silver
30518 <small>NEW</small>	30,0 x 30,0	14,0	8,0	 black / silver



**Dressingtopf / Flaschenkühler „FROSTFIRE“**

dressing pot / bottle cooler  
salsera / enfriador de botella  
pot à sauce / rafraîchisseur

Antihafbeschichtung / non stick coating / antiadherente / revêtement anti-adhésif

	Ø cm	cm	ltr.	Farbe / colour
36140	11,5 / 11	15	1,4	 black / silver





auch als Flaschenkühler verwendbar  
also usable as a bottle cooler



Schale „FROSTFIRE“

bowl  
cuenco  
bol

Antihafbeschichtung / non stick coating / antiadherente / revêtement anti-adhésif

	Ø cm	cm	ltr.	Farbe / colour
30017	26,5	7 / 12	1,9	 beige / sand
30019	26,5	7 / 12	1,9	 red
30018	26,5	7 / 12	1,9	 green
30015	26,5	7 / 12	1,9	 black / silver
30016	26,5	7 / 12	1,9	 black







# FROSTFIRE



## Schale „FROSTFIRE“

bowl  
cuenco  
bol

Antihafbeschichtung / non stick coating / antiadherente / revêtement anti-adhésif

	Ø cm	cm	ltr.	Farbe / colour
30024	32,5	8 / 14	3	 beige / sand
30014	32,5	8 / 14	3	 red
30013	32,5	8 / 14	3	 green
30010	32,5	8 / 14	3	 black / silver
30011	32,5	8 / 14	3	 black



**Wärmelampe mit 2 Infrarotlampen**

thermal bridge  
puente térmico  
pont thermique

**höhenverstellbar 58 - 77,5 cm, inklusive 2 Lampen, Kabellänge: 1,5 Meter**

height adjustable from 58 to 77,5 cm, including 2 infrared lamps, cable length: 1,5 metres  
regulable en altura de 58 a 77,5 cm, con 2 lámparas de infrarrojas, longitud del cable: 1,5 metros  
réglable en hauteur de 58 à 77,5 cm, avec 2 lampes infrarouges, longueur du câble: 1,5 mètre

	cm	cm	V	W
12265	50 x 35	58 - 77,5	230	2 x 250

**Ersatzbirne für Wärmelampe**

infrared lamp / bulb  
lámpara infrarroja / bombilla  
lampe infrarouge / ampoule

**Fassung E27, Lichtfarbe: warmweiß**

socket: E27, light colour: warm white  
casquillo: E27, color de la luz: blanco cálido  
douille: E27, couleur de lumière: blanc chaud

	W	fits to
12266	250	12265, 12267



**Wärmelampe mit Infrarotlampe**

thermal bridge  
puente térmico  
pont thermique

**mit flexibel einstellbarem Arm, stabiler Standfuß, Kabellänge: 1,5 Meter**

with flexibly adjustable arm, stable base, cable length: 1,5 metres  
con brazo ajustable de forma flexible, base estable, longitud del cable: 1,5 metros  
avec bras réglable de manière flexible, socle stable, longueur de câble : 1,5 mètre

	cm	cm	V	W
12267	27 x 20,5	68	230	1 x 250

**Ersatzbirne für Wärmelampe**

infrared lamp / bulb  
lámpara infrarroja / bombilla  
lampe infrarouge / ampoule

**Fassung E27, Lichtfarbe: warmweiß**

socket: E27, light colour: warm white  
casquillo: E27, color de la luz: blanco cálido  
douille: E27, couleur de lumière: blanc chaud

	W	fits to
12266	250	12265, 12267





NEW

**Brat- und Servierpfanne „5 STARS“**  
 frying and serving pan  
 poêle à frire et à servir  
 sartén para freír y servir





88340 2 ltr.



88341 2 ltr.



88342 2 ltr.

	Ø cm	cm	ltr.	Farbe / colour
88340	29	5,5	2	
88341	29	5,5	2	
88342	29	5,5	2	

NEW



88330 0,35 ltr.



88331 0,35 ltr.



88332 0,35 ltr.

## Mini-Topf mit Deckel „5 STARS“

mini pot with lid

mini olla con tapa

mini casserole avec couvercle

	Ø cm	cm	ltr.	Farbe / colour
88330	11	6,5 / 9	0,35	
88331	11	6,5 / 9	0,35	
88332	11	6,5 / 9	0,35	



NEW



88333 0,45 ltr.



88334 0,45 ltr.



88335 0,45 ltr.

## Mini-Topf mit Deckel „5 STARS“

mini pot with lid

mini olla con tapa

mini casserole avec couvercle

	Ø cm	cm	ltr.	Farbe / colour
88333	14,5 x 11,5	6,5 / 9	0,45	
88334	14,5 x 11,5	6,5 / 9	0,45	
88335	14,5 x 11,5	6,5 / 9	0,45	



**5 STARS**



**Kochtopf mit Deckel „5 STARS“**

cooking pot with lid  
olla con tapa  
marmite avec couvercle

	Ø cm	cm	ltr.	Farbe / colour
88302	25	11,5 / 17,5	4	
88303	25	11,5 / 17,5	4	
88313	25	11,5 / 17,5	4	



inklusive Deckelhalter  
including lid holder



**Kochtopf mit Deckel „5 STARS“**

cooking pot with lid  
olla con tapa  
marmite avec couvercle

	Ø cm	cm	ltr.	Farbe / colour
88306	28	13 / 20	6	
88307	28	13 / 20	6	
88315	28	13 / 20	6	



inklusive Deckelhalter  
including lid holder



88300 2,5 ltr.





88301 2,5 ltr.



88312 2,5 ltr.

### Bräter mit Deckel „5 STARS“

roaster with lid  
cacerola con tapa  
cocotte avec couvercle

	Ø cm	cm	ltr.	Farbe / colour
88300	25	7 / 13	2,5	
88301	25	7 / 13	2,5	
88312	25	7 / 13	2,5	



inklusive Deckelhalter  
including lid holder



88304 3 ltr.



88305 3 ltr.



88314 3 ltr.

### Bräter mit Deckel „5 STARS“

roaster with lid  
cacerola con tapa  
cocotte avec couvercle

	Ø cm	cm	ltr.	Farbe / colour
88304	28	7 / 13,5	3	
88305	28	7 / 13,5	3	
88314	28	7 / 13,5	3	



inklusive Deckelhalter  
including lid holder



**Bräter mit Deckel „5 STARS“**

roaster with lid  
cacerola con tapa  
cocotte avec couvercle

	cm	cm	ltr.	Farbe / colour
88308	33 x 25	11 / 17,5	5	
88309	33 x 25	11 / 17,5	5	
88316	33 x 25	11 / 17,5	5	



inklusive Deckelhalter  
including lid holder



**Deckelhalter, 2er Set**

lid holder, 2 pcs.  
soporte para tapa, set de 2  
support de couvercle, set de 2  
**mit Antirutschbeschichtung, für alle Töpfe mit Deckel einsetzbar, hitzebeständig**  
with non-slip coating, suitable for all pots with lids, heat-resistant  
con revestimiento antideslizante, apto para todas las ollas con tapa, resistente al calor  
avec revêtement antidérapant, adapté à toutes les casseroles avec couvercle, résistant à la chaleur

	cm	cm	Farbe / colour	pcs.
88320	10,5 x 8,5	3,5		2



## Auflaufform „5 STARS“

casserole dish  
fuente para gratinar  
plat à four

	cm	cm	ltr.	Farbe / colour
88310	33 x 24	6,5	3,5	
88311	33 x 24	6,5	3,5	
88317	33 x 24	6,5	3,5	



88310 3,5 ltr.



88311 3,5 ltr.



88317 3,5 ltr.





12344



12342



12343



12330



12335

**Chafing Dish, 4-teiliges Set „ORBIT“**

chafing dish set, 4 pcs.  
chafing dish, set de 4  
chafing dish, set de 4

- 1 Topf (8 Liter), 1 Speisenbehälter (4 Liter), 1 Deckel mit Sichtfenster und 1 Deckelbremse
- 1 pot (8 litres), 1 foodpan (4 litres), 1 lid with glass insert and 1 automatic lid brake
- 1 olla (8 litros), 1 cubeta (4 litros), 1 tapa con ventanilla y 1 sistema de freno en la tapa
- 1 casserole (8 litres), 1 bac (4 litres), 1 couvercle avec fenêtre et 1 frein de couvercle

	Ø cm	cm	ltr.	Farbe / colour
12344 <span style="color:red">NEW</span>	30,5	17,5	4	sand
12342	30,5	17,5	4	vintage-look
12343	30,5	17,5	4	gold
12330	30,5	17,5	4	stainless steel
12335	30,5	17,5	4	copper



12342



abnehmbarer Deckel  
removable lid

induktionsgeeignet  
suitable for induction

Ersatz-Speisenbehälter zu Chafing Dish / replacement foodpan for chafing dish / cubeta interior de repuesto para chafing dish / bac intérieur de remplacement pour le chafing dish

	Ø cm	cm	ltr.	fits to
12329	30,5	8	4	12330, 12335, 12336, 12337, 12338, 12339, 12342, 12343, 12344



Ø 33 cm

8 ltr. Topf  
8 ltr. pot



12329

Ø 30,5 cm

4 ltr. Speisenbehälter  
4 ltr. foodpan

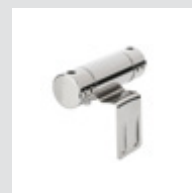

Deckelbremse  
automatic lid break



Sandwich- / Kapsel-  
boden / sandwich base



12336



12337



12338



12339

### Chafing Dish, 4-teiliges Set „ORBIT“

chafing dish set, 4 pcs.

chafing dish, set de 4

chafing dish, set de 4

• 1 Topf (8 Liter), 1 Speisenbehälter (4 Liter), 1 Deckel mit Sichtfenster und 1 Deckelbremse

• 1 pot (8 litres), 1 foodpan (4 litres), 1 lid with glass insert and 1 automatic lid brake

• 1 olla (8 litros), 1 cubeta (4 litros), 1 tapa con ventanilla y 1 sistema de freno en la tapa

• 1 casserole (8 litres), 1 bac (4 litres), 1 couvercle avec fenêtre et 1 frein de couvercle

	Ø cm	cm	ltr.	Farbe / colour
12336	30,5	17,5	4	yellow
12337	30,5	17,5	4	red
12338	30,5	17,5	4	black
12339	30,5	17,5	4	green

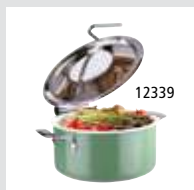

abnehmbarer Deckel  
removable lid

induktionsgeeignet  
suitable for induction

Ersatz-Speisenbehälter zu Chafing Dish / replacement foodpan for chafing dish / cubeta interior de repuesto para chafing dish / bac intérieur de remplacement pour le chafing dish

	Ø cm	cm	ltr.	fits to
12329	30,5	8	4	12330, 12335, 12336, 12337, 12338, 12339, 12342, 12343, 12344



8 ltr. Topf  
8 ltr. pot



4 ltr. Speisenbehälter  
4 ltr. foodpan



Deckelbremse  
automatic lid break



Sandwich- / Kapsel-  
boden / sandwich base



82212 2 x 1,4 ltr.



82211 3 ltr.

### Porzellaneinsatz „ORBIT“

porcelain insert

bandeja de porcelana

bac en porcelaine

	Ø cm	cm	ltr.	fits to
82212	29,5	9	2,8	12330, 12335, 12336, 12337, 12338, 12339, 12342, 12343, 12344
82211	29,5	9	3,0	12330, 12335, 12336, 12337, 12338, 12339, 12342, 12343, 12344



passend zur Serie „ORBIT“  
suitable for the „ORBIT“ series



40360  
GN 1/1 – 6,5 cm



40361  
GN 1/2 – 6,5 cm



40362  
GN 1/3 – 6,5 cm



40363  
GN 1/4 – 6,5 cm



40364  
GN 1/6 – 6,5 cm



40365  
GN 2/4 – 6,5 cm

**GN Korb „TWIRL“**

GN basket  
GN cesta  
GN corbeille



stabile Ausführung mit pulverbeschichtetem Edeldraht zur Stabilisierung  
very solid with powder-coated stainless steel wire to stabilize the basket  
muy resistente, con refuerzo de acero inoxidable para mayor estabilidad  
très résistant avec renfort en acier inoxydable pour plus de stabilité

	cm	cm	GN
40360	53,0 x 32,5	6,5	1/1
40361	32,5 x 26,5	6,5	1/2
40362	32,5 x 17,6	6,5	1/3
40363	26,5 x 16,2	6,5	1/4
40364	17,6 x 16,2	6,5	1/6
40365	53,0 x 16,2	6,5	2/4



**GN Korb „TWIRL“**

GN basket

GN cesta

GN corbeille



stabile Ausführung mit pulverbeschichtetem Edelstahldraht zur Stabilisierung

very solid with powder-coated stainless steel wire to stabilize the basket

muy resistente, con refuerzo de acero inoxidable para mayor estabilidad

très résistant avec renfort en acier inoxydable pour plus de stabilité



40370  
GN 1/1 – 10 cm



40371  
GN 1/2 – 10 cm



40372  
GN 1/3 – 10 cm



40373  
GN 1/4 – 10 cm



40374  
GN 1/6 – 10 cm



40375  
GN 2/4 – 10 cm

	cm	cm	GN
40370	53,0 x 32,5	10	1/1
40371	32,5 x 26,5	10	1/2
40372	32,5 x 17,6	10	1/3
40373	26,5 x 16,2	10	1/4
40374	17,6 x 16,2	10	1/6
40375	53,0 x 16,2	10	2/4



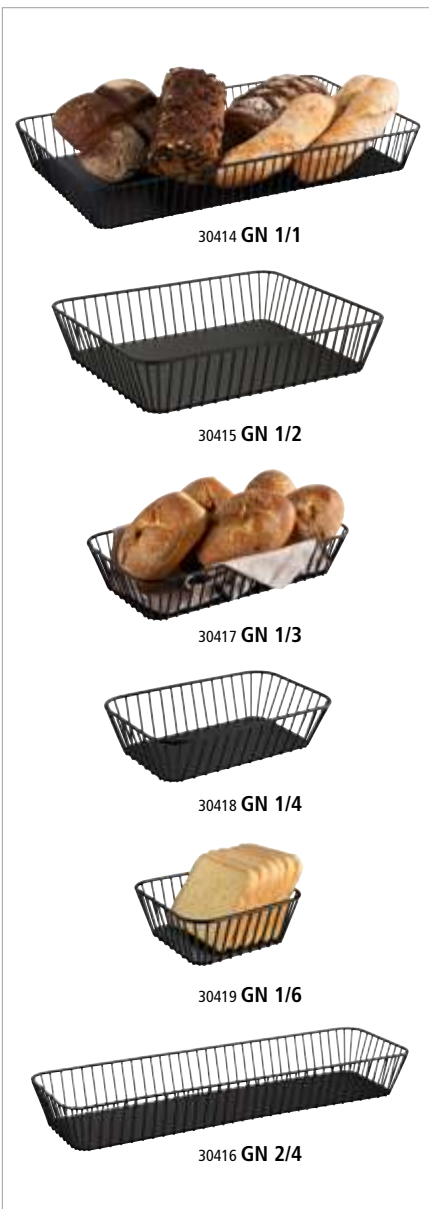

**GN Korb „URBAN“**

GN basket  
GN cesta  
GN corbeille

METAL

	cm	cm	GN
30414	53,0 x 32,5	7	1/1
30415	32,5 x 26,5	7	1/2
30417	32,5 x 17,6	7	1/3
30418	26,5 x 16,2	7	1/4
30419 <small>NEW</small>	17,6 x 16,2	7	1/6
30416	53,0 x 16,2	7	2/4

	GN 1/2	GN 1/3	GN 1/4	GN 1/6	
GN 1/1		GN 1/3		GN 1/6	GN 2/4
	GN 1/2	GN 1/3	GN 1/4	GN 1/6	



30410



30411

**Korb „URBAN“**

basket  
cesta  
corbeille

	Ø cm	cm
30410	17	6,5
30411	20	8,0



**Korb „URBAN“**

basket  
cesta  
corbeille

	cm	cm
30412	21 x 10	6,5



**Korb „URBAN“**

basket  
cesta  
corbeille

	cm	cm
30337	29 x 16	6,5



**Brot- und Obstkorb „URBAN“**

basket for bread or fruits  
cesta para pan o fruta  
corbeille à pain ou à fruits

	Ø cm	cm
30211	22,5	28

# CRAFT



NEW



40687



40688





40689

## Schale „CRAFT“

bowl  
cuenco  
bol



gehämmerte Oberfläche  
hammered surface  
superficie martillada  
surface martelée

	cm	cm	ltr.	Farbe / colour
40687	8,5 x 6,5	5,5	0,15	 gold-look
40688	8,5 x 6,5	5,5	0,15	 copper-look
40689	8,5 x 6,5	5,5	0,15	 gunmetal-look



**Schale „CRAFT“**

bowl  
cuenco  
bol  
gehämmerte Oberfläche  
hammered surface  
superficie martillada  
surface martelée

	cm	cm	ltr.	Farbe / colour	
40696	12,0 x 9,5	5,0	0,35		gold-look
40697	12,0 x 9,5	5,0	0,35		copper-look
40698	12,0 x 9,5	5,0	0,35		gunmetal-look



**Schale „CRAFT“**

bowl  
cuenco  
bol  
gehämmerte Oberfläche  
hammered surface  
superficie martillada  
surface martelée

	cm	cm	ltr.	Farbe / colour	
40690	15,5 x 12	5,5	0,7		gold-look
40691	15,5 x 12	5,5	0,7		copper-look
40692	15,5 x 12	5,5	0,7		gunmetal-look

**Schale „CRAFT“**

bowl  
cuenco  
bol  
gehämmerte Oberfläche  
hammered surface  
superficie martillada  
surface martelée

	cm	cm	ltr.	Farbe / colour	
40693	23 x 15,5	6,0	1,4		gold-look
40694	23 x 15,5	6,0	1,4		copper-look
40695	23 x 15,5	6,0	1,4		gunmetal-look



3,8 ltr.

10818



5 ltr.

10819



7 ltr.

10855

**Getränkespender**

beverage dispenser  
dispensador de bebidas  
distributeur de boissons

Behälter aus Glas, Zapfhahn aus Edelstahl, Deckel aus Edelstahl

glass container, stainless steel tap, lid in stainless steel

recipiente de vidrio, grifo de acero inoxidable, tapa de acero inoxidable

réipient en verre, robinet en acier inox, couvercle en acier inox

	Ø cm	cm	ltr.
10818	16	25,0	3,8
10819 <small>NEW</small>	20	23,0	5,0
10855	20	30,5	7,0



10849

Eiswasserröhre separat erhältlich  
ice cube cooling tube available separately



**Untersetzer**

saucer  
plattillo  
sous-assiette



**Untersetzer für Getränkespender, schützt den Untergrund vor Wasserrändern**

saucer for beverage dispensers, protects the surface from water marks  
plattillo para dispensadores de bebidas, protege la superficie las marcas de agua contra  
sous-assiette pour distributeurs de boissons, protège le support contre les traces d'eau

	Ø cm	cm	fits to
85233	16	1	10818
85232	19	1	10855, 10819



**Tropfenschale, 2-teilig**

drip tray, 2 pcs.  
aros anti-goteo, set de 2  
anneaux coupe-gouttes, set de 2



	Ø cm	cm	Farbe / colour
10851	9,5	1,5	white
10841	9,5	1,5	black



**Eiswasserröhre**

ice cube cooling tube  
tubo enfriador para cubitos  
tube pour glaçons

	Ø cm	cm	fits to beverage dispensers
10849	11	23	10400, 10403, 10450, 10451, 10452, 10460, 10818, 10855, 14015, 14016, 14025, 14115, 14125





**Wein- / Sektkühler „AUREO“**

wine / champagne bowl  
 cubitera para vino / cava  
 seau à vin / champagne

hochwertige äußere Facettierung, Rand & Bodenring in Gunmetal-Look

high-quality outer bevelling, rim & base ring in gunmetal look

facetas exteriores de alta calidad, aro y anillo de base en gunmetal

facettage extérieure de haute qualité, bord & anneau de fond en look gunmetal

	Ø cm	cm	ltr.
36160	28	25	10





10725  
0,5 ltr.

10726  
1,0 ltr.

10727  
1,5 ltr.

### Glaskaraffe „LINES“

glass carafe  
jarra de vidrio  
carafe en verre

GLASS

CORK

ideal für Cerealien, Säfte oder Milch, Deckel aus Kork

ideal for cereals, juices or milk, cork lid

ideal para cereales, zumos o leche, tapa de corcho

idéal pour les céréales, les jus de fruits ou le lait, couvercle en liège

	Ø cm	cm	ltr.
10725	9	19,5	0,5
10726	9	27,5	1,0
10727	9	35,0	1,5



0,75 ltr.

### Glaskaraffe „LINES“

glass carafe  
jarra de vidrio  
carafe en verre

GLASS

CORK

ideal für Cerealien, Säfte oder Milch, Deckel aus Kork

ideal for cereals, juices or milk, cork lid

ideal para cereales, zumos o leche, tapa de corcho

idéal pour les céréales, les jus de fruits ou le lait, couvercle en liège

	Ø cm	cm	ltr.
10738	8	28	0,75



NEW



2,0 ltr.

### Soft- & Wasserkanne

juice & water pitcher  
jarra de zumo & agua  
pichet à eau & jus de fruit

mit Edelstahldeckel und integriertem Sieb – ideal für Wasser, Saft oder Infused-Drinks  
with stainless steel lid and integrated strainer – ideal for water, juice, or infused drinks  
con tapa de acero inoxidable y colador integrado – ideal para agua, zumo o bebidas infusionadas  
avec couvercle en acier inox et filtre intégré – idéal pour l'eau, les jus ou les boissons infusées

	Ø cm	cm	ltr.
10728	13	23	2



2-farbig / 2 colours



**NEW** FRIGIO



### Eisbecher, 2er Set „FRIGIO“

ice cream cup, set of 2  
copa de helado, set de 2  
sundae, set de 2

ideal als Eisbecher, Dessertschale oder für das Flying Buffet

ideal as an ice cream cup, dessert bowl or for the flying buffet

ideal como copa de helado, cuenco de postre o para el flying buffet

idéal comme coupe à glace, coupe à dessert ou pour le flying buffet

	Ø cm	cm	ml	pcs.
40910	10,5	8,5	180	2

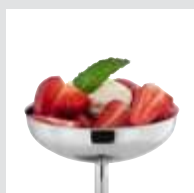

### Eisbecher, 2er Set „FRIGIO“

ice cream cup, set of 2  
copa de helado, set de 2  
sundae, set de 2

ideal als Eisbecher, Dessertschale oder für das Flying Buffet

ideal as an ice cream cup, dessert bowl or for the flying buffet

ideal como copa de helado, cuenco de postre o para el flying buffet

idéal comme coupe à glace, coupe à dessert ou pour le flying buffet

	Ø cm	cm	ml	pcs.
40911	10,5	14,0	260	2



# PERFECTION



**UNZERBRECHLICH**  
UNBREAKABLE



NEW

## Martiniglas „PERFECTION“

Martini glass  
copa de Martini  
verre à Martini

	Ø cm	cm	ml	VE / unit
10545	12	17	200	12



NEW

## Cocktailglas „PERFECTION“

cocktail glass  
copa de cóctel  
verre à cocktail

	Ø cm	cm	ml	VE / unit
10546	7,5	20,5	400	12



## Sektglas „PERFECTION“

champagne glass  
copa de champán  
flûte à champagne

	Ø cm	cm	ml	VE / unit
10540	5	23	190	12



**Weißweinglas „PERFECTION“**

white wine glass  
 copa de vino blanco  
 verre à vin blanc

	Ø cm	cm	ml	VE / unit
10541	8	21,5	320	12



**Rotweinglas „PERFECTION“**

red wine glass  
 copa de vino tinto  
 verre à vin rouge

	Ø cm	cm	ml	VE / unit
10542	10,5	21	600	12



**Trinkglas „PERFECTION“**

drinking glass  
 vaso para beber  
 verre à boire

	Ø cm	cm	ml	VE / unit
10543	8	11,5	330	12



**Trinkglas „PERFECTION“**

drinking glass  
 vaso para beber  
 verre à boire

	Ø cm	cm	ml	VE / unit
10544	8	15	470	12



UNZERBRECHLICH  
 UNBREAKABLE



**Espressotasse „SNUG“**  
 espresso cup  
 taza de espresso  
 tasse à espresso



	Ø cm	cm	ml	Farbe / colour	VE / unit
16000	6	5,5	80		6
16001	6	5,5	80		6
16002	6	5,5	80		6



**Espressountertasse „SNUG“**  
 espresso saucer  
 platillo de espresso  
 soucoupe à espresso



	Ø cm	cm	Farbe / colour	VE / unit
16009	11,5	2		6
16010	11,5	2		6
16011	11,5	2		6



**Kaffeetasse „SNUG“**

coffee cup  
taza de café  
tasse à café



	Ø cm	cm	ml	Farbe / colour	VE / unit
16003	9,5	6	200		6
16004	9,5	6	200		6
16005	9,5	6	200		6



**Kaffeuntertasse „SNUG“**

coffee saucer  
platillo de café  
soucoupe à café



	Ø cm	cm		Farbe / colour	VE / unit
16012	14,5	2,5			6
16013	14,5	2,5			6
16014	14,5	2,5			6



**Cappuccinotasse „SNUG“**

cappuccino cup  
taza de cappuccino  
tasse à cappuccino



	Ø cm	cm	ml	Farbe / colour	VE / unit
16006	10,5	6,5	300		6
16007	10,5	6,5	300		6
16008	10,5	6,5	300		6



**Cappuccinounterstasse „SNUG“**

cappuccino saucer  
platillo de cappuccino  
soucoupe cappuccino



	Ø cm	cm		Farbe / colour	VE / unit
16015	15,5	2,5			6
16016	15,5	2,5			6
16017	15,5	2,5			6

NEW



16018



16019





16020

Kaffeebecher „SNUG“

coffee mug  
taza de café  
tasse à café

PORCELAIN

	Ø cm	cm	ml	Farbe / colour	VE / unit
16018	8,5	10	330		6
16019	8,5	10	330		6
16020	8,5	10	330		6

NEW



16024



16025



16026

Teller „SNUG“

plate  
plato  
assiette

PORCELAIN



	Ø cm	cm	Farbe / colour	VE / unit
16024	20,5	2		6
16025	20,5	2		6
16026	20,5	2		6

NEW

Schale „SNUG“

bowl  
cuenco  
bol

PORCELAIN

	Ø cm	cm	ml	Farbe / colour	VE / unit
16021	12	6	250		6
16022	12	6	250		6
16023	12	6	250		6



16021



16022



16023





VELMA



**Tischset „VELMA“**  
 placemat  
 mantelín  
 set de table

	cm	Farbe / colour
60591	45 x 33	hellbraun / light brown



rutschhemmende Unterseite  
 non-slip bottom



**Tischset „VELMA“**  
 placemat  
 mantelín  
 set de table

	cm	Farbe / colour
60590	45 x 33	hellblau transparent / light blue transparent



transparent, rutschhemmende Unterseite  
 transparent, non-slip bottom

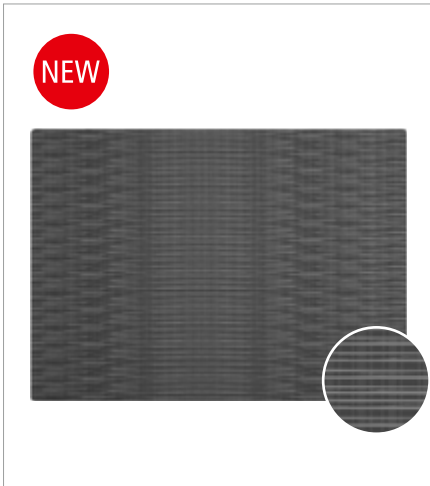

Tischset „VELMA“  
 placemat  
 mantelín  
 set de table

	cm	Farbe / colour
60589	45 x 33	grau / grey

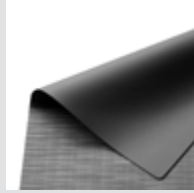

rutschhemmende Unterseite  
 non-slip bottom



Tischset „VELMA“  
 placemat  
 mantelín  
 set de table

	cm	Farbe / colour
60588	45 x 33	hellbraun / light brown



rutschhemmende Unterseite  
 non-slip bottom



Tischset „VELMA“  
 placemat  
 mantelín  
 set de table

	cm	Farbe / colour
60587	45 x 33	hellblau transparent / light blue transparent

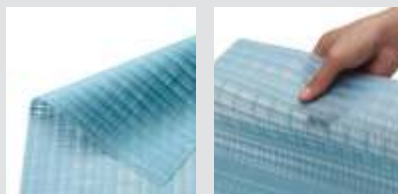

transparent, rutschhemmende Unterseite  
 transparent, non-slip bottom

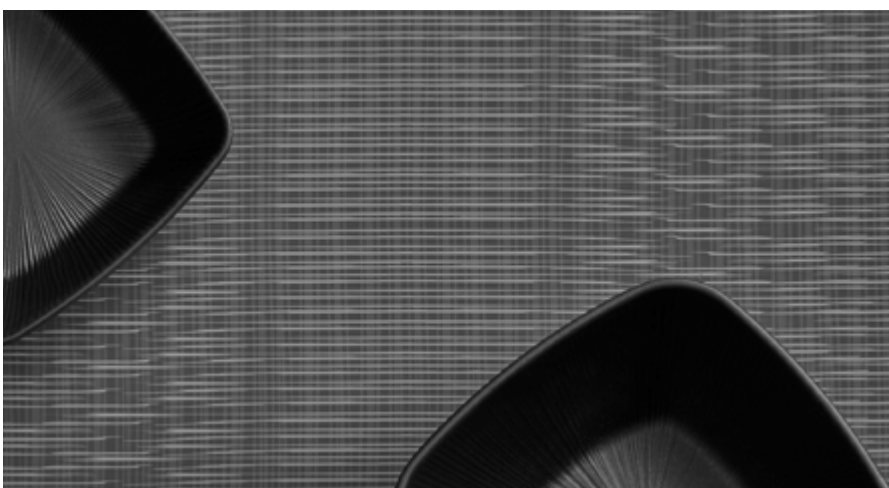

# PLACEMATS



**Tischset „VELMA“**  
 placemat  
 mantelín  
 set de table

	cm	Farbe / colour
60580	45 x 33	beige / beige



**rutschhemmende Unterseite**  
 non-slip bottom



**Tischset „VELMA“**  
 placemat  
 mantelín  
 set de table

	cm	Farbe / colour
60581	45 x 33	grün / green



**rutschhemmende Unterseite**  
 non-slip bottom

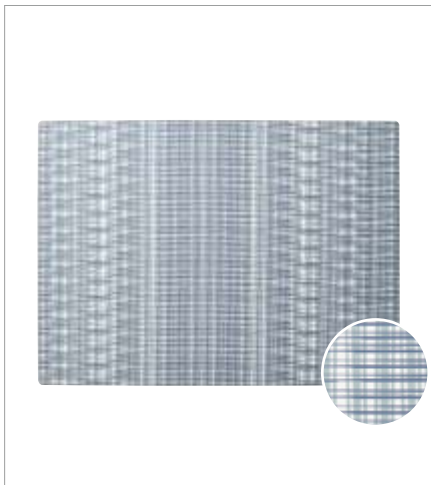

**Tischset „VELMA“**  
 placemat  
 mantelín  
 set de table

	cm	Farbe / colour
60582	45 x 33	blau / blue



**rutschhemmende Unterseite**  
 non-slip bottom





**Tischset „VELMA“**

placemat  
mantelín  
set de table

	cm	Farbe / colour
60584	45 x 33	beige / beige



rutschhemmende Unterseite  
non-slip bottom



**Tischset „VELMA“**

placemat  
mantelín  
set de table

	cm	Farbe / colour
60583	45 x 33	anthrazit / anthracite



rutschhemmende Unterseite  
non-slip bottom



**Tischset „VELMA“**

placemat  
mantelín  
set de table

	cm	Farbe / colour
60585	45 x 33	grün / green



rutschhemmende Unterseite  
non-slip bottom



**Tischset „VELMA“**

placemat  
mantelín  
set de table

	cm	Farbe / colour
60586	45 x 33	dunkelblau / dark blue



rutschhemmende Unterseite  
non-slip bottom

NEW

SOHO



✓  
inklusive Ladestation  
charging station included

✓  
USB Ladekabel  
USB charging cable

✓  
Fernbedienung inkl. Batterie  
remote control incl. battery

✓  
möbelschonende Unterseite  
furniture-friendly underside



**17120**  
glossy chrome



**17121**  
glossy black



**17122**  
glossy cashmere

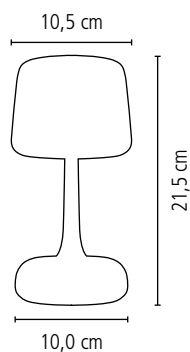

### Tischleuchte

table lamp  
lámpara de mesa  
lampe de table

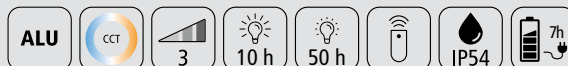

**inklusive Ladestation, USB Ladekabel (ohne Netzteil), Fernbedienung inklusive Batterie**  
charging station included, USB charging cable (without mains adapter), remote control including battery  
con estación de carga, cable de carga USB (sin adaptador de red), mando a distancia inclusivo pila  
avec station de charge, câble de charge USB (sans bloc d'alimentation), télécommande avec pile

	cm	cm	Farbe / colour
17120	10,5 x 10,5	21,5	glossy chrome
17121	10,5 x 10,5	21,5	glossy black
17122	10,5 x 10,5	21,5	glossy cashmere



Teller „CALA“  
plate  
plato  
assiette



	cm	cm
85470	19,0 x 14,5	2,5
85471	27,0 x 21,0	2,5
85472	33,5 x 26,0	2,5



**Teller „CALA“**

plate  
plato  
assiette



	cm	cm
85473	34 x 15,0	2,5

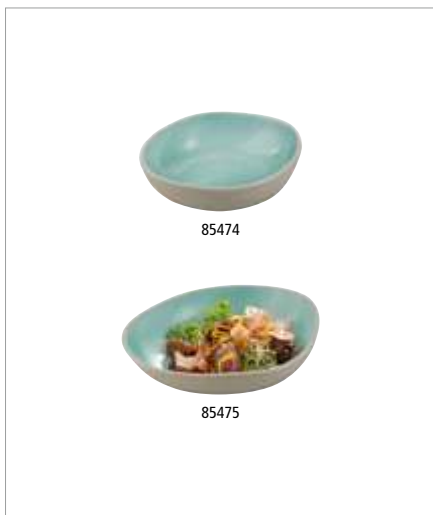

**Schale „CALA“**

bowl  
cuenco  
bol



	cm	cm	ltr.
85474	15 x 13,5	4,5	0,25
85475	20,5 x 18,0	4,5	0,50



**Schale „CALA“**

bowl  
cuenco  
bol



	cm	cm	ltr.
85476	16,0 x 14,5	7,0	0,7
85477	20,0 x 18,5	8,5	1,2





NEW

ARUMI



85600 GN 1/1

85601 GN 1/2

85602 GN 2/4

GN Tablett „ARUMI“

GN tray  
GN bandeja  
GN plateau



	cm	cm	GN
85600	53,0 x 32,5	3	1/1
85601	32,5 x 26,5	3	1/2
85602	53,0 x 16,2	3	2/4

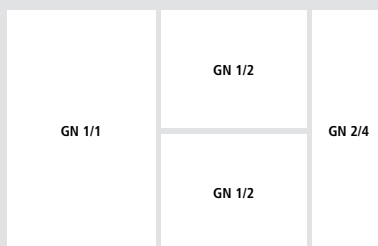

Teller „ARUMI“

plate  
plato  
assiette



	Ø cm	cm	litr.
85605	22,5	4,5	0,8



## Teller „ARUMI“

plate  
plato  
assiette



	Ø cm	cm
85603	21	3
85604	26	3



## Schale „ARUMI“

bowl  
cuenco  
bol



	Ø cm	cm	ltr.
85606	16	6	0,5
85607	19	8	1,0



## Schale „ARUMI“

bowl  
cuenco  
bol



	cm	cm	ltr.
85608	19 x 19	8	1,1
85609	25 x 25	11	2,8





NEW

FLORYN



85440 GN 1/1

85441 GN 1/2

85442 GN 2/4

GN Tablett „FLORYN“

GN tray  
GN bandeja  
GN plateau



	cm	cm	GN
85440	53,0 x 32,5	2,5	1/1
85441	32,5 x 26,5	2,5	1/2
85442	53,0 x 16,2	2,5	2/4

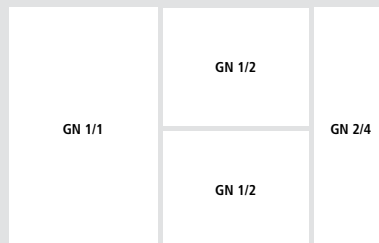

Tablett „FLORYN“

tray  
bandeja  
plateau



	cm	cm
85446	40,5 x 24,5	2,5



**Teller „FLORYN“**

plate  
plato  
assiette



	Ø cm	cm
85443	15,5	2
85444	21,5	2
85445	27,0	2

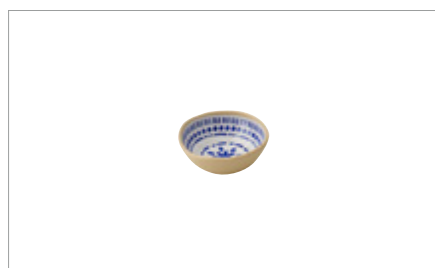

**Schale „FLORYN“**

bowl  
cuenco  
bol



	Ø cm	cm	ltr.
85447	8	3	0,05

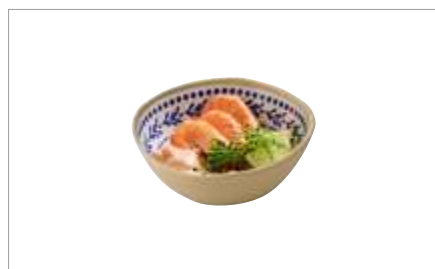

**Schale „FLORYN“**

bowl  
cuenco  
bol



	Ø cm	cm	ltr.
85448	16	6,5	0,5



**Schale „FLORYN“**

bowl  
cuenco  
bol



	Ø cm	cm	ltr.
85449	20	9	1,3



**Schale „FLORYN“**

bowl  
cuenco  
bol



	Ø cm	cm	ltr.
85450	19	5	0,45
85451	33	6	2,40



**NEW**



85325 GN 1/1



85326 GN 1/2



85327 GN 1/3



85328 GN 2/4

**GN Tablett „FOOTMARK“**

GN tray  
GN bandeja  
GN plateau



	cm	cm	GN
85325	53,0 x 32,5	1,5	1/1
85326	32,5 x 26,5	1,5	1/2
85327	32,5 x 17,6	1,5	1/3
85328	53,0 x 16,2	1,5	2/4





Teller „FOOTMARK“

plate  
plato  
assiette



	Ø cm	cm
85323	21,0	2,0
85324	26,5	2,5



Teller, tief „FOOTMARK“

plate, deep  
plato, hondo  
assiette, creuse



	Ø cm	cm	ltr.
85322	24	4,0	0,8

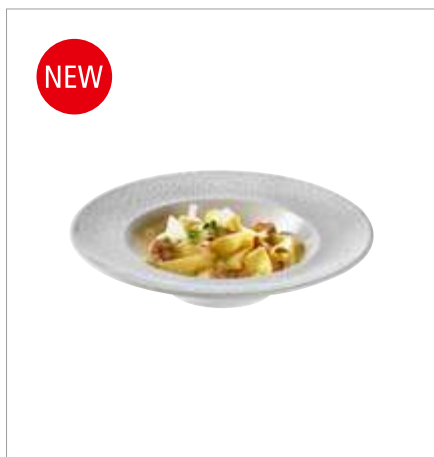

Teller „FOOTMARK“

plate  
plato  
assiette



	Ø cm	cm	ltr.
85329	26,5	5,5	0,5



Schale „FOOTMARK“

bowl  
cuenco  
bol



	Ø cm	cm	ltr.
85320	13	5,5	0,25
85321	18	5,5	0,6
85319 <b>NEW</b>	24	9,0	2,0



NERO



GN Tablett „NERO“

GN tray  
GN bandeja  
GN plateau



	cm	cm	GN
85400	53,0 x 32,5	2,5	1/1
85401	32,5 x 26,5	2,5	1/2
85420 <b>NEW</b>	32,5 x 17,6	2,5	1/3
85421 <b>NEW</b>	26,5 x 16,2	2,5	1/4
85402	53,0 x 16,2	2,5	2/4

GN 1/1	GN 1/2	GN 1/3	GN 2/4	GN 1/4
	GN 1/2	GN 1/3		GN 1/4



Tablett „NERO“

tray  
bandeja  
plateau  
mit 2 integrierten Dipschälchen  
with 2 integrated dip bowls  
con 2 cuencos para dip integrados  
avec 2 ramequins intégrés



	cm	cm	ltr.
85426	41 x 15	2,5	2 x 0,03

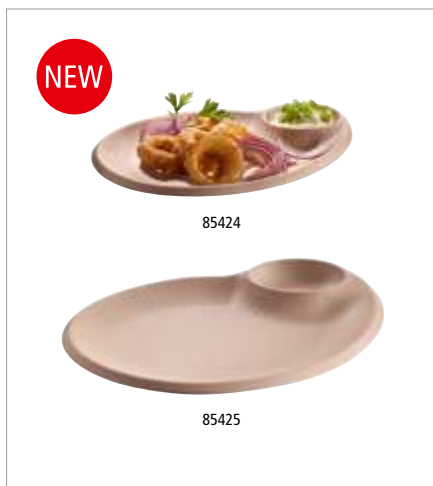

**Teller „NERO“**

plate  
plato  
assiette

mit integriertem Dipschälchen

with integrated dip bowl

con cuenco para dip integrado

avec ramequin intégré



	cm	cm	ltr.
85424	24 x 20	2,5	0,04
85425	30 x 25	2,5	0,06

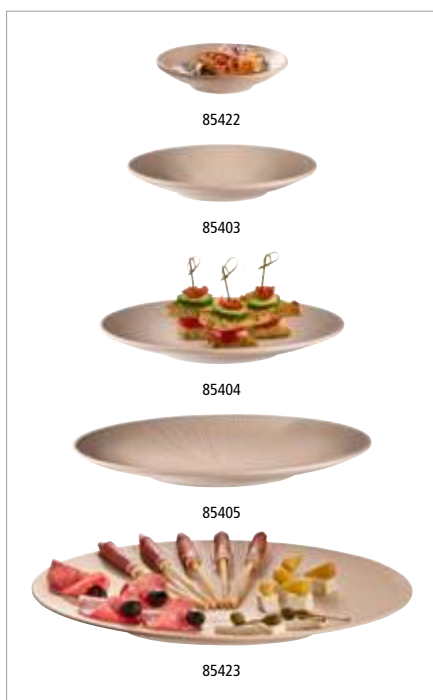

**Teller „NERO“**

plate  
plato  
assiette



	Ø cm	cm
85422 <b>NEW</b>	15	3,0
85403	21	3,0
85404	26	3,0
85405	33	3,5
85423 <b>NEW</b>	42	3,5



**Teller „NERO“**

plate  
plato  
assiette



	Ø cm	cm	ltr.
85406	29	6	0,3



**Schale „NERO“**

bowl  
cuenco  
bol



	cm	cm	ltr.
85416	19,5 x 19,5	8	1,5
85417	25,0 x 25,0	11	3,5

# NERO

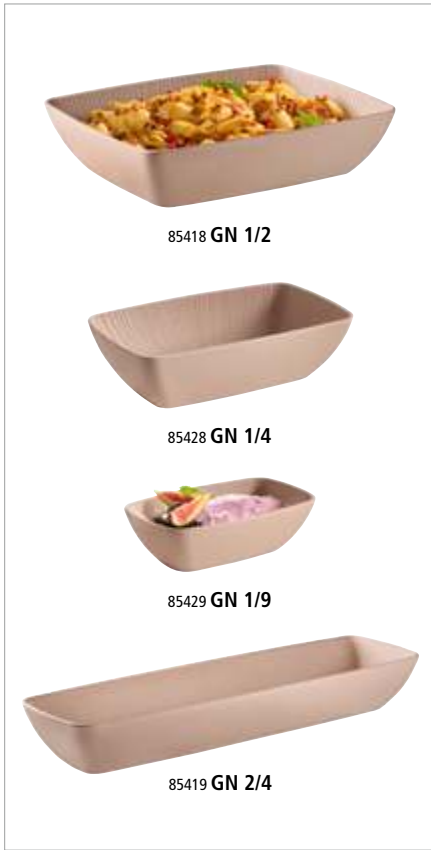

## GN Schale „NERO“

GN bowl  
GN cuenco  
GN bol

	cm	cm	ltr.	GN
85418	32,5 x 26,5	7,5	3,50	1/2
85428 <b>NEW</b>	26,5 x 16,2	7,5	1,50	1/4
85429 <b>NEW</b>	17,6 x 10,8	5,5	0,35	1/9
85419	53,0 x 16,2	7,5	3,50	2/4



## Schale „NERO“

bowl  
cuenco  
bol

	Ø cm	cm	ltr.	VE / unit
85430	8	2	0,03	24



## Schale „NERO“

bowl  
cuenco  
bol

	Ø cm	cm	ltr.
85427 <b>NEW</b>	7,0	3,5	0,07
85407	8,5	3,5	0,1



## Schale „NERO“

bowl  
cuenco  
bol



	Ø cm	cm	ltr.
85411	16	6,5	0,5
85412	19	8,0	0,9
85413	24	9,0	1,7



Schale „NERO“

bowl  
cuenco  
bol



	Ø cm	cm	ltr.
85414	22,5	4,5	0,8
85415	30,0	7,0	2,2
85431 <b>NEW</b>	35,0	8,0	3,4

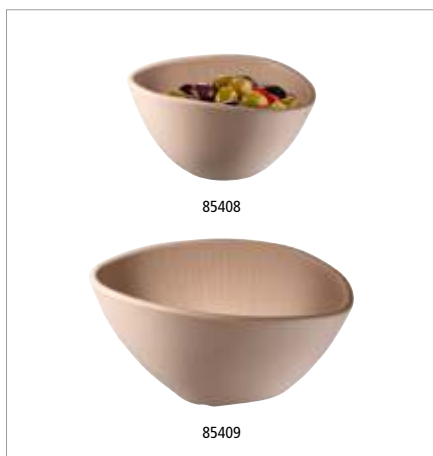

Schale „NERO“

bowl  
cuenco  
bol



	cm	cm	ltr.
85408	14,5 x 12,5	8	0,3
85409	19,0 x 16,5	9	0,5



Schale „NERO“

bowl  
cuenco  
bol



	cm	cm	ltr.
85410	23 x 18	5	0,6



# BLUSH



## GN Tablett „BLUSH“

GN tray  
GN bandeja  
GN plateau



	cm	cm	GN
85500	53,0 x 32,5	2,5	1/1
85501	32,5 x 26,5	2,5	1/2
85512 <small>NEW</small>	32,5 x 17,6	2,5	1/3
85513 <small>NEW</small>	26,5 x 16,2	2,5	1/4
85502	53,0 x 16,2	2,5	2/4

GN 1/1	GN 1/2	GN 1/3	GN 2/4	GN 1/4
	GN 1/2	GN 1/3		GN 1/4
		GN 1/3	GN 1/4	

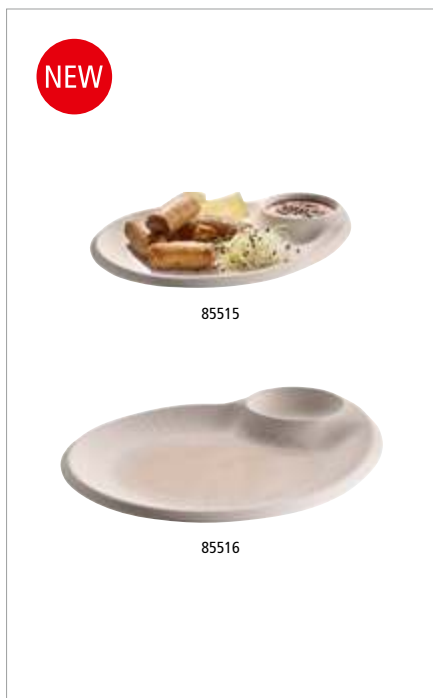

**Teller „BLUSH“**

plate  
plato  
assiette

mit integriertem Dipschälchen

with integrated dip bowl

con cuenco para dip integrado

avec ramequin intégré



	cm	cm	ltr.
85515	24 x 20	2,5	0,04
85516	30 x 25	2,5	0,06

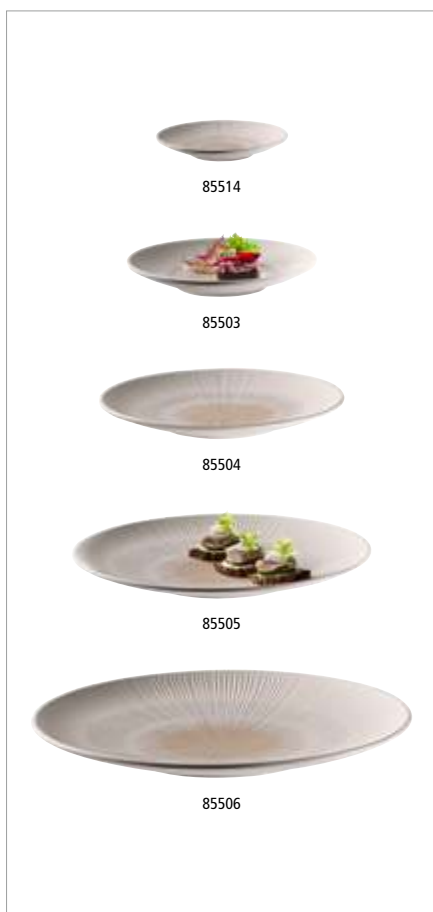

**Teller „BLUSH“**

plate  
plato  
assiette



	Ø cm	cm
85514 <sup>new</sup>	15	3,0
85503	21	3,0
85504	26	3,0
85505	33	3,5
85506	42	3,5



**Teller „BLUSH“**

plate  
plato  
assiette



	Ø cm	cm	ltr.
85507	29	6	0,3

# BLUSH



## Schale „BLUSH“

bowl  
cuenco  
bol



EACH  
PIECE  
UNIQUE

	Ø cm	cm	ltr.	VE / unit
85523	8	2	0,03	24



## Schale „BLUSH“

bowl  
cuenco  
bol



EACH  
PIECE  
UNIQUE

	Ø cm	cm	ltr.
85521	7,0	3,5	0,07
85522	8,5	3,5	0,10

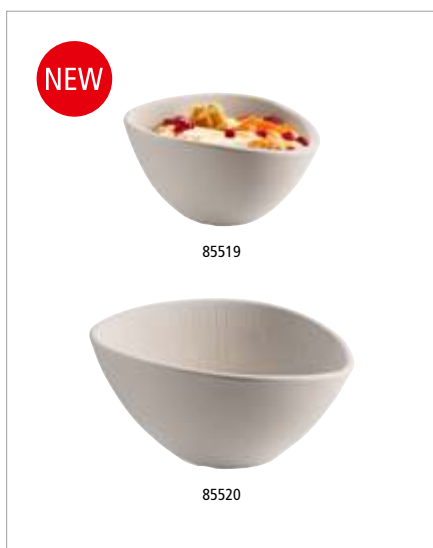

## Schale „BLUSH“

bowl  
cuenco  
bol



EACH  
PIECE  
UNIQUE

	cm	cm	ltr.
85519	14,5 x 12,5	8	0,3
85520	19,0 x 16,5	9	0,5

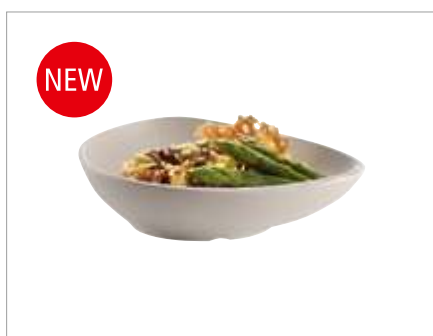

## Schale „BLUSH“

bowl  
cuenco  
bol



EACH  
PIECE  
UNIQUE

	cm	cm	ltr.
85518	23 x 18	5	0,6



Schale „BLUSH“

bowl  
cuenco  
bol



	Ø cm	cm	ltr.
85508	16	6,5	0,5
85509	19	8,0	0,9
85517 <b>NEW</b>	24	9,0	1,7

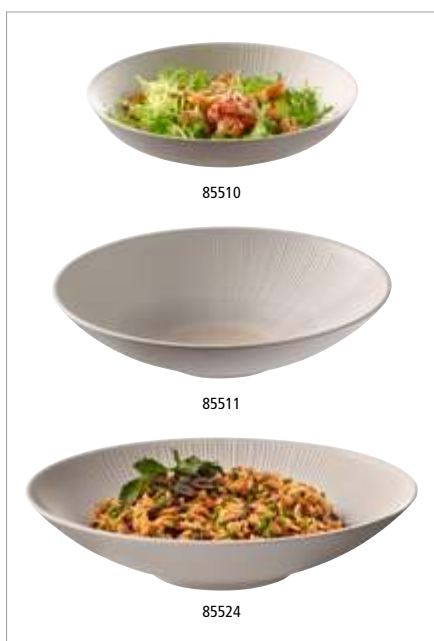

Schale „BLUSH“

bowl  
cuenco  
bol



	Ø cm	cm	ltr.
85510	22,5	4,5	0,8
85511	30,0	7,0	2,2
85524 <b>NEW</b>	35,0	8,0	3,4



jeder Artikel ist ein Unikat  
each item is unique



**GN Tablett „NERO“**

GN tray  
GN bandeja  
GN plateau



	cm	cm	GN
85067	53,0 x 32,5	2,5	1/1
85068	32,5 x 26,5	2,5	1/2
85280	32,5 x 17,6	2,5	1/3
85281	26,5 x 16,2	2,5	1/4
85275	53,0 x 16,2	2,5	2/4

GN 1/1	GN 1/2	GN 1/3	GN 2/4	GN 1/4
	GN 1/2	GN 1/3		GN 1/4
		GN 1/3		



**Tablett „NERO“**

tray  
bandeja  
plateau

mit 2 integrierten Dipschälchen / with 2 integrated dip bowls /  
con 2 cuencos para dip integrados / avec 2 ramequins intégrés



	cm	cm	ltr.
85097	41 x 15	2,5	2 x 0,03



85074

85075

**Teller „NERO“**

plate  
plato  
assiette

mit integriertem Dipschälchen

with integrated dip bowl  
con cuenco para dip integrado  
avec ramequin intégré



	cm	cm	ltr.
85074	24 x 20	2,5	0,04
85075	30 x 25	2,5	0,06



85073

85284

85063

85064

85285

85065

85066

**Teller „NERO“**

plate  
plato  
assiette



	Ø cm	cm
85073	15	3,0
85284 <small>NEW</small>	18	3,0
85063	21	3,0
85064	26	3,0
85285 <small>NEW</small>	29	3,0
85065	33	3,5
85066	42	3,5



Servierplatte „NERO“

serving plate  
plato de servir  
plateau de service



	Ø cm	cm
85283	50	3,5



Teller „NERO“

plate  
plato  
assiette



	Ø cm	cm	ltr.
85098	29	6	0,3



Schale „NERO“

bowl  
cuenco  
bol



	Ø cm	cm	ltr.	VE / unit
85292	8	2	0,03	24

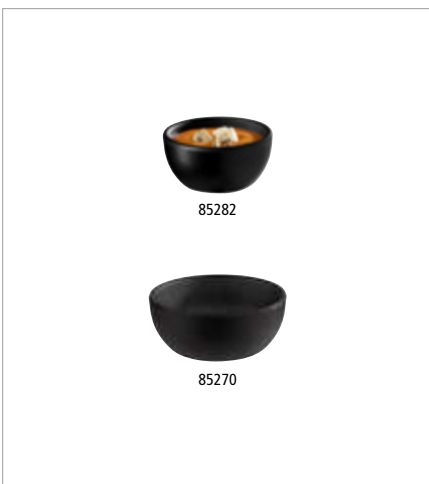

Schale „NERO“

bowl  
cuenco  
bol



	Ø cm	cm	ltr.
85282	7,0	3,5	0,07
85270	8,5	3,5	0,10



85271



85272



85273

Schale „NERO“

bowl  
cuenco  
bol



	Ø cm	cm	ltr.
85271	12,5	4,5	0,25
85272	15,5	5,5	0,45
85273	20,5	7,5	1,20



85286



85287



85069



85070



85061



85288

Schale „NERO“

bowl  
cuenco  
bol



	Ø cm	cm	ltr.
85286 <b>NEW</b>	10	5,5	0,15
85287 <b>NEW</b>	13	6,0	0,3
85069	16	6,5	0,5
85070	19	8,0	0,9
85061	24	9,0	1,7
85288 <b>NEW</b>	29	10,0	2,8



Schale „NERO“  
bowl  
cuenco  
bol

	Ø cm	cm	ltr.
85060	22,5	4,5	0,8
85062	30,0	7,0	2,2
85289	35,0	8,0	3,4

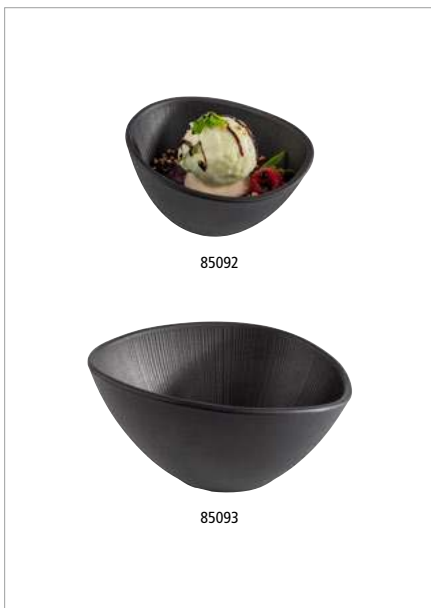

Schale „NERO“  
bowl  
cuenco  
bol

	cm	cm	ltr.
85092	14,5 x 12,5	8	0,3
85093	19,0 x 16,5	9	0,5



Schale „NERO“  
bowl  
cuenco  
bol

	cm	cm	ltr.
85076	23 x 18	5	0,6
85077	28 x 22	7	0,8

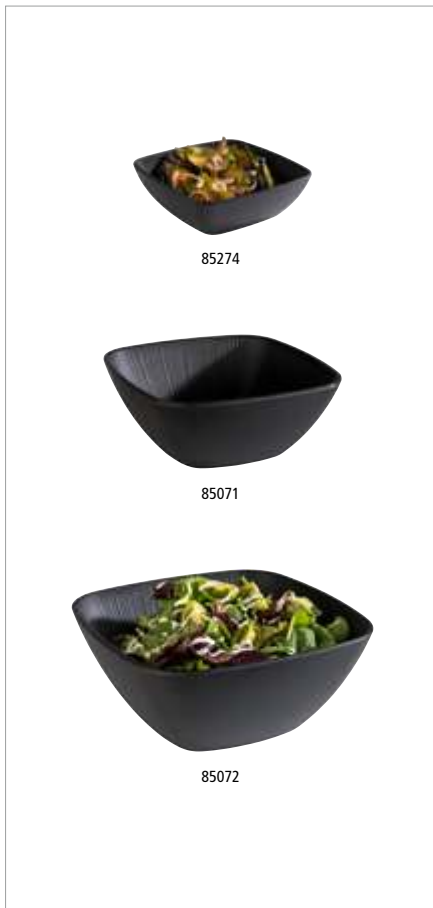

Schale „NERO“

bowl  
cuenco  
bol



	cm	cm	ltr.
85274	16,5 x 16,5	5,5	0,6
85071	19,5 x 19,5	8,0	1,5
85072	25,0 x 25,0	11,0	3,5

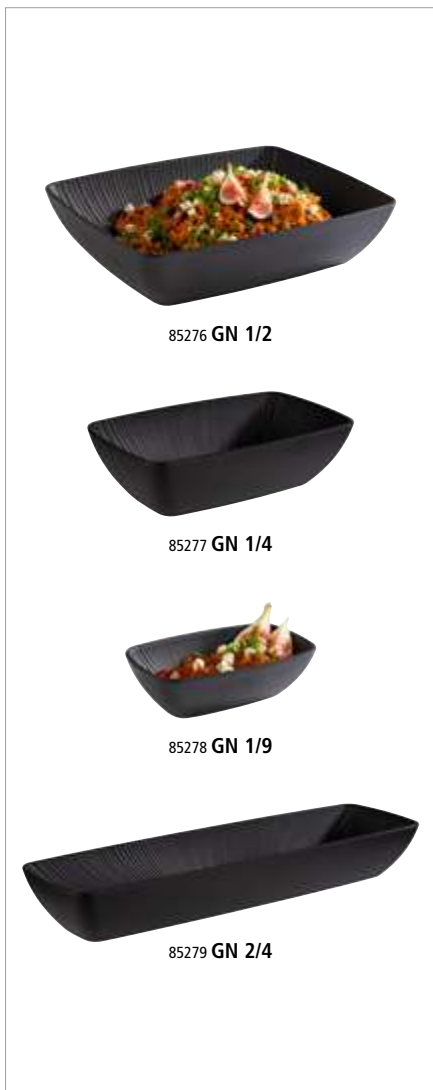

GN Schale „NERO“

GN bowl  
GN cuenco  
GN bol



	cm	cm	ltr.	GN
85276	32,5 x 26,5	7,5	3,50	1/2
85277	26,5 x 16,2	7,5	1,50	1/4
85278	17,6 x 10,8	5,5	0,35	1/9
85279	53,0 x 16,2	7,5	3,50	2/4

GN 1/2	GN 1/4	GN 1/9	
		GN 1/9	GN 2/4
GN 1/2	GN 1/4	GN 1/9	



**GN Tablett „CANCUN“**

GN tray  
GN bandeja  
GN plateau



	cm	cm	GN
85224	32,5 x 26,5	1,5	1/2

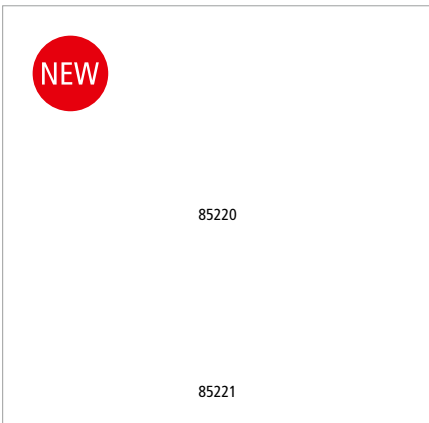

**Teller „CANCUN“**

plate  
plato  
assiette



	Ø cm	cm
85220	22	2
85221	27	2



**Teller „CANCUN“**

plate  
plato  
assiette



	Ø cm	cm
85202	18	3,0
85203	23	3,5



**Teller „CANCUN“**

plate  
plato  
assiette



	Ø cm	cm
85204	25,5	4,5



**Tablett / Sushiboard „CANCUN“**

tray / sushiboard  
bandeja para sushi  
plateau sushi



	cm	cm
85200	23,5 x 13,5	1,5



**Teller „CANCUN“**

plate  
plato  
assiette



	cm	cm
85201	28 x 13,5	4
85223 <small>NEW</small>	34 x 15,5	4



**Schale „CANCUN“**

bowl  
cuenco  
bol



	Ø cm	cm	litr.
85205	15,0	7	0,5
85206	18,5	8	1,0
85208	24,0	9	1,8

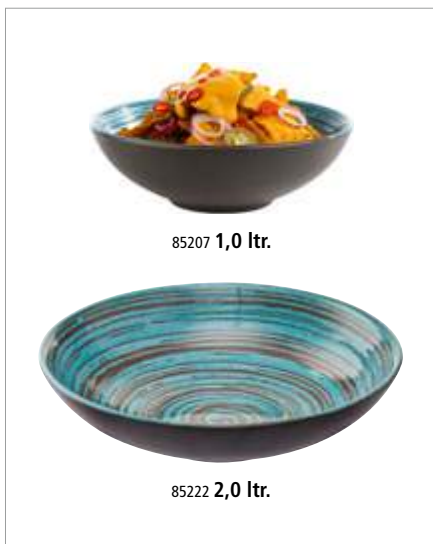

**Schale „CANCUN“**

bowl  
cuenco  
bol



	Ø cm	cm	litr.
85207	20,5	6,5	1
85222 <small>NEW</small>	31,0	8,0	2



NEW UMI

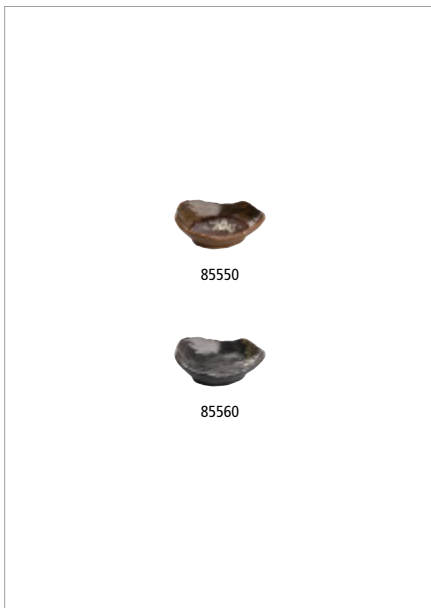

Schale „UMI“

bowl  
cuenco  
bol



	cm	cm	ml	Farbe / colour	VE / unit
85550	10 x 8,5	3	50		12
85560	10 x 8,5	3	50		12



Tablett / Sushiboard „UMI“

tray / sushiboard  
bandeja para sushi  
plateau sushi



	cm	cm	Farbe / colour
85551	28,5 x 11,5	2	
85561	28,5 x 11,5	2	



Tablett / Sushiboard „UMI“  
tray / sushiboard  
bandeja para sushi  
plateau sushi





	cm	cm	Farbe / colour
85552	35 x 10	3	
85562	35 x 10	3	



Tablett / Sushiboard „UMI“  
tray / sushiboard  
bandeja para sushi  
plateau sushi



	cm	cm	Farbe / colour
85553	41 x 13	3	
85563	41 x 13	3	





**NEW** KAYA



Schale „KAYA“  
bowl  
cuenco  
bol



	Ø cm	cm	ml	VE / unit
85360	8,0	2,5	80	12

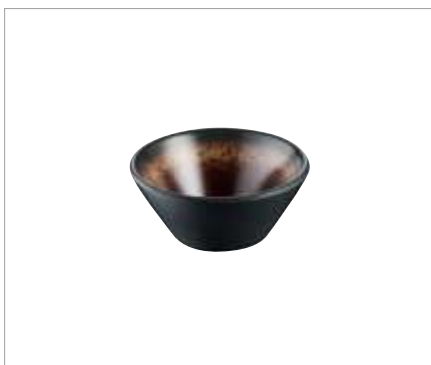

Schale „KAYA“  
bowl  
cuenco  
bol



	Ø cm	cm	ml	VE / unit
85361	8,5	3,5	100	12



Schale „KAYA“  
bowl  
cuenco  
bol

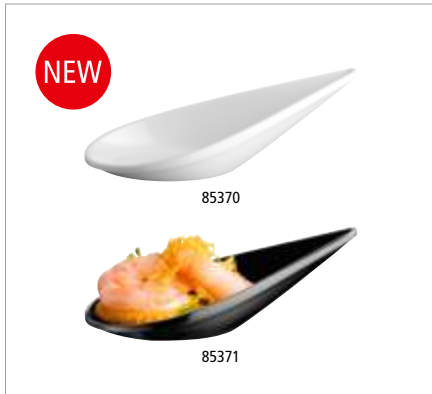

	Ø cm	cm	ml	VE / unit
85362	8,0	4,0 / 5,5	90	12

**Fingerfoodlöffel „DROP“**

party spoon  
cuchara party  
cuillère party

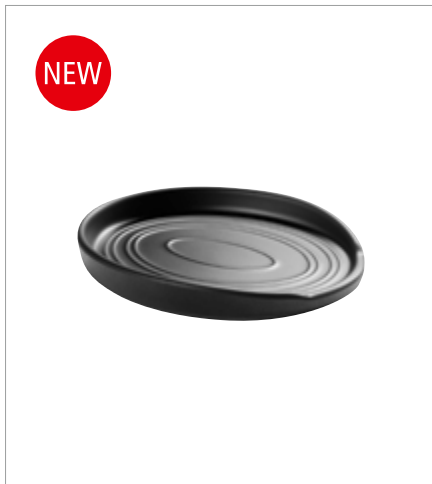

	cm	cm	Farbe / colour	VE / unit
85370	10,5 x 5,5	3	white shiny	12
85371	10,5 x 5,5	3	black shiny	12

**Besteckablage „OVANA“**

cutlery tray  
reposa cuchara  
pose-cuillère

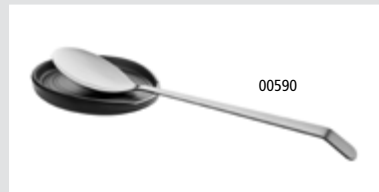

	cm	cm	Farbe / colour
85380	16 x 12	2	black matt

**Universalzange**

all-purpose tongs  
pinza universal  
pince universelle

	cm	cm	Farbe / colour
75825	7 x 5	22,5	vintage-look
75830	7 x 5	25,0	mirror polished
75831	7 x 5	25,0	gold-look (PVD)
75832	7 x 5	25,0	copper-look (PVD)

**Salat- / Servierlöffel „BANQUET“**

salad spoon / serving spoon  
cuchara para ensalada / cuchara de servicio  
cuillère à salade / cuillère de service

	cm	Griff / handle cm
00588	6,0 x 5,0	17
00590	7,5 x 6,0	21

# EGGY



## Eierbecher Farbmix, 4er Set „EGGY“

egg holder colour mix, 4 pcs. set  
huevera mezcla de colores, set de 4  
coquetier mélange de couleurs, set de 4







	Ø cm	cm	pcs.	Farbe / colour
85298	8,5	2	4	 colour mix matt



## Eierbecher, 4er Set „EGGY“

egg holder, 4 pcs. set  
huevera, set de 4  
coquetier, set de 4



	Ø cm	cm	pcs.	Farbe / colour
85297 <span style="color:red">NEW</span>	8,5	2	4	 yellow matt
85295	8,5	2	4	 green matt
85296	8,5	2	4	 grey matt
83849	8,5	2	4	 black matt
83848	8,5	2	4	 white shiny

NEW

**Dose, 2er Set „TERRAZZO“**

container, 2 pcs.  
recipiente, set de 2  
boîte, set de 2

**ideal zum Servieren von Aufstrichen, Butter, Gewürzen oder kleinen Delikatessen**

ideal for serving spreads, butter, spices, or small delicacies

ideal para servir untables, mantequilla, especias o pequeñas delicias

idéal pour servir des tartinades, du beurre, des épices ou de petites gourmandises

	Ø cm	cm	ml	Farbe / colour
15917	6	5	40	 terrazzo

NEW

**Dose, 2er Set „MINERA“**

container, 2 pcs.  
recipiente, set de 2  
boîte, set de 2

**ideal zum Servieren von Aufstrichen, Butter, Gewürzen oder kleinen Delikatessen**

ideal for serving spreads, butter, spices, or small delicacies

ideal para servir untables, mantequilla, especias o pequeñas delicias

idéal pour servir des tartinades, du beurre, des épices ou de petites gourmandises

	Ø cm	cm	ml	Farbe / colour
15918	6	5	40	 travertin look

NEW

**Dose, 2er Set „MINERA“**

container, 2 pcs.  
recipiente, set de 2  
boîte, set de 2

**ideal zum Servieren von Aufstrichen, Butter, Gewürzen oder kleinen Delikatessen**

ideal for serving spreads, butter, spices, or small delicacies

ideal para servir untables, mantequilla, especias o pequeñas delicias

idéal pour servir des tartinades, du beurre, des épices ou de petites gourmandises

	Ø cm	cm	ml	Farbe / colour
15919	6	5	40	 marble green

**Dose, 2er Set „MINERA“**

container, 2 pcs.  
recipiente, set de 2  
boîte, set de 2

**ideal zum Servieren von Aufstrichen, Butter, Gewürzen oder kleinen Delikatessen**

ideal for serving spreads, butter, spices, or small delicacies

ideal para servir untables, mantequilla, especias o pequeñas delicias

idéal pour servir des tartinades, du beurre, des épices ou de petites gourmandises

	Ø cm	cm	ml	Farbe / colour
15920	6	5	40	 marble black

Farb- und Strukturabweichungen möglich  
colour and texture variations possible

40701

87027

00864

11727



**NEW** EVERLINE



**Trinkflasche „EVERLINE“**

drinking bottle  
botella para beber  
gourde

facettiertes Liniendesign, Trinkflasche aus Glas, Deckel aus Edelstahl  
faceted line design, glass drinking bottle, stainless steel lid  
diseño de líneas facetadas, botella de vidrio, tapa de acero inoxidable  
design de ligne à facettes, gourde en verre, couvercle en acier inox

	Ø cm	cm	ltr.
66950	6,5	19,5	0,4
66951	6,5	23,0	0,5
66952	7,0	26,0	0,7



mit Schraubverschluss  
with screw cap



# EVERFILL



## Trinkflasche „EVERFILL“

drinking bottle  
botella para beber  
gourde

Trinkflasche aus Glas, Deckel aus Edelstahl

glass drinking bottle, stainless steel lid  
botella de vidrio, tapa de acero inoxidable  
gourde en verre, couvercle en acier inox

	Ø cm	cm	ltr.
66935 <small>NEW</small>	6,5	15,0	0,30
66936 <small>NEW</small>	6,5	18,0	0,40
66907	6,5	23,5	0,55
66908	7,0	26,5	0,75
66909	7,5	28,5	1,00



mit Schraubverschluss  
with screw cap





### Mehrwegbecher „TO GO“

reusable cup  
vaso reutilizable  
tasse réutilisable

**Becher (ohne Deckel), Rillendesign isoliert die Hitze ohne die Handflächen zu verbrennen**  
cup (without cover), grooved design insulates the heat without burning your hands  
vaso (sin tapa), el diseño acanalado aísla el calor sin quemarte las manos  
tasse (sans couvercle), le design rainuré isole la chaleur sans brûler les mains

	Ø cm	cm	ml	Farbe / colour
66930 <small>NEW</small>	8,5	11,0	300	
66931 <small>NEW</small>	8,5	11,0	300	
66932 <small>NEW</small>	8,5	11,0	300	
66911	8,5	13,5	400	
66912	8,5	13,5	400	
66913	8,5	13,5	400	



### Deckel / cover / tapa / couvercle

	Ø cm	cm	Farbe / colour
66915	8,5	2,5	
66916	8,5	2,5	
66917	8,5	2,5	

## BRANDING

Gerne bieten wir eine individuelle Gestaltung an.

We are happy to offer an individual design.



**1 Deckel | cover**  
 Ø 8,5 cm | H 2,5 cm  
 1,10 € / Stück (brutto) | pcs. (gross)

**2 Becher, ohne Druck | cup, without print**  
 Ø 8,5 cm | H 11,0 cm  
 2,00 € / Stück (brutto) | pcs. (gross)  
 Ø 8,5 cm | H 13,5 cm  
 2,20 € / Stück (brutto) | pcs. (gross)

sofort verfügbar | immediately available



**3 1-farbiger Druck | 1-colour print**  
 1,15 € / Stück (netto) | pcs. (net) | (MOQ 500)  
 1,00 € / Stück (netto) | pcs. (net) | (MOQ 1.000)

**4 2-farbiger Druck | 2-colour print**  
 1,35 € / Stück (netto) | pcs. (net) | (MOQ 500)  
 1,15 € / Stück (netto) | pcs. (net) | (MOQ 1.000)

**5 4-farbiger Druck | 4-colour print**  
 2,20 € / Stück (netto) | pcs. (net) | (MOQ 500)  
 2,00 € / Stück (netto) | pcs. (net) | (MOQ 1.000)

**6 Relief / Prägung | relief / embossing**  
 0,45 € / Stück (netto) | pcs. (net) | (MOQ 1.000)

3-4 Wochen | 3-4 weeks delivery time

8 Wochen | 8 weeks delivery time

Druckvorlagen sollten als Vektorgrafik angeliefert werden. Der Druck wird anschließend eingebrannt, sodass der Becher weiterhin spülmaschinengeeignet ist.

Artwork should be supplied as a vector graphic. The print is then burned in so that the cup is still dishwasher-safe.

- ✓ aufsteckbarer Deckel mit Trinköffnung  
clip-on lid with drinking opening
- ✓ 100 % recyclebar  
100 % recyclable
- ✓ spülmaschinengeeignet  
dishwasher safe
- ✓ stapelbar mit und ohne Deckel  
stackable with and without lid
- ✓ schwappsicher  
slosh-/leak-proof



## TABLE ACCESSORIES



NEW

### Besteckbehälter „TRAVERTINE“

cutlery bin  
recipiente para cubiertos  
récipients pour couverts

**Travertine (Kalkstein), mit Abflussloch, Bodeneinlage aus Silikon zum Schonen des Bestecks**

travertine (limestone), with drain hole, silicone bottom insert for protecting the points of knives

travertino (caliza), con orificio de drenaje, soporte de silicona para proteger las puntas de los cuchillos

travertin (calcaire), avec le trou de drainage, insert de silicone pour protéger les pointes des couteaux

	Ø cm	cm
11756	11	13,5

Farb- und Strukturabweichungen möglich  
colour and texture variations possible

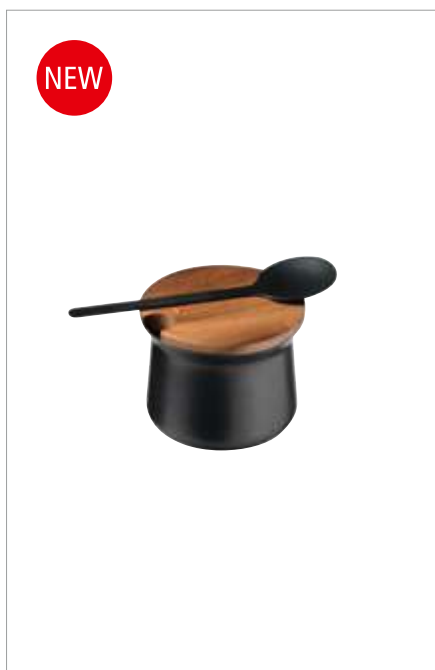

NEW

### Zuckerdose, 3-tlg. Set

sugar bowl, 3 pcs.  
azucarero, set de 3  
sucrier, set de 3

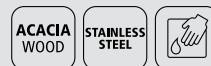

**3-teiliges Set, bestehend aus: 1 Zuckerdose, 1 Deckel, 1 Löffel**

3 pcs., consisting of: 1 sugar bowl, 1 lid, 1 spoon

set de 3, compuesto por: 1 azucarero, 1 tapa, 1 cuchara

set de 3, composé de: 1 sucrier, 1 couvercle, 1 cuillère

	Ø cm	cm	ml
00633	8	6,5	200



NEW

### Windaschenbecher „TERRAZZO“

ashtray  
cenicero  
cendrier

**windgeschütztes Design, Asche bleibt sicher im Becher**

windproof design, ash remains safely in the cup

diseño protegido contra el viento, las cenizas permanecen seguras en el recipiente

conception protégée du vent, les cendres restent bien dans le récipient

	Ø cm	cm	Farbe / colour
00557	10,5	5	 terrazzo



Farb- und Strukturabweichungen möglich  
colour and texture variations possible

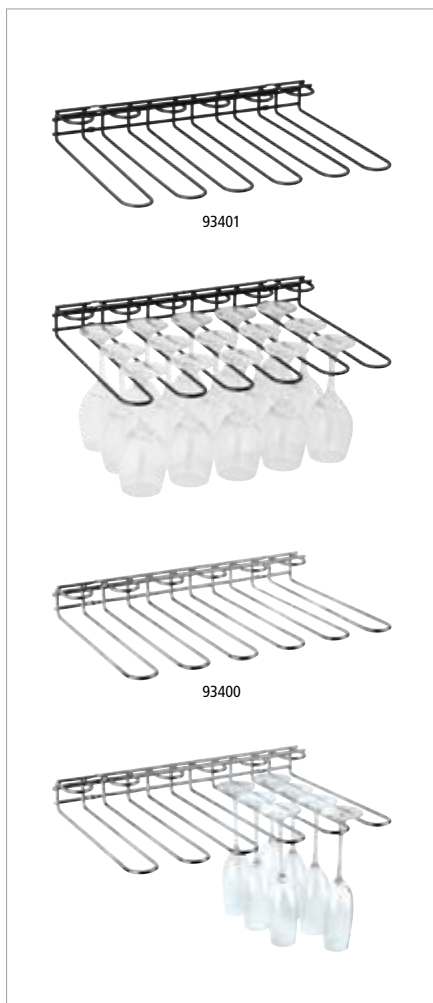

### Gläserchiene

glass rack  
rack de copas  
rack porte-verres



**inklusive Befestigungsmaterial, Wand- und Deckenmontage möglich**

includes mounting hardware, can be mounted under a shelf or on the wall  
incluye material de fijación, puede instalarse bajo una estantería o en la pared  
matériel de fixation inclus, à installer sous une étagère ou contre un mur

	cm	cm	Farbe / colour	
93401 <small>NEW</small>	45 x 32	6		black matt
93400	45 x 32	6		chrome

Gläser nicht im Lieferumfang enthalten  
glasses not included in delivery

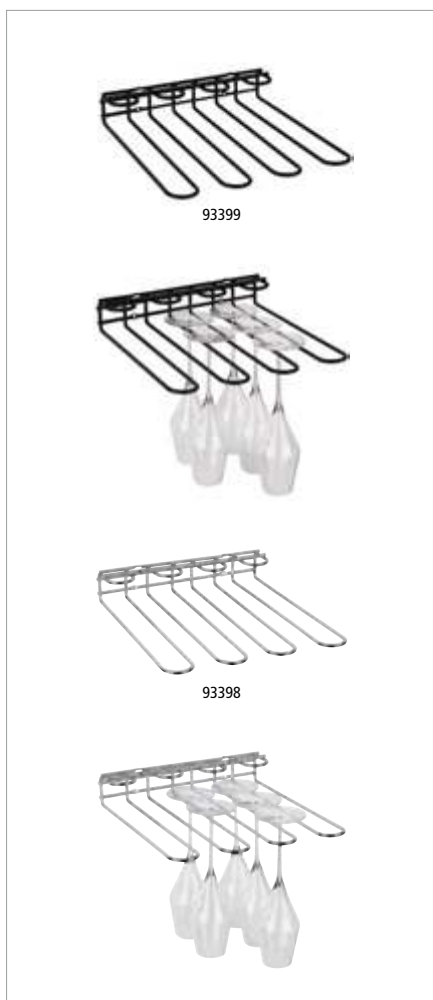

### Gläserchiene

glass rack  
rack de copas  
rack porte-verres



**inklusive Befestigungsmaterial, Wand- und Deckenmontage möglich**

includes mounting hardware, can be mounted under a shelf or on the wall  
incluye material de fijación, puede instalarse bajo una estantería o en la pared  
matériel de fixation inclus, à installer sous une étagère ou contre un mur

	cm	cm	Farbe / colour	
93399	29,5 x 32	6		black matt
93398	29,5 x 32	6		chrome

Gläser nicht im Lieferumfang enthalten  
glasses not included in delivery

## GN CONTAINERS



### GN-Behälter

GN-container  
GN cubetas  
GN bacs

PP



**transparent: Skalierung in Liter, robust und formstabil**

transparent: liter scale, solid quality

transparente: graduación en litros, alta calidad

transparent: graduation en litres, haute-qualité

	GN	↓ mm	ltr.	cm
82104	1/1	65	8,5	53 x 32,5
82106	1/1	100	13,0	53 x 32,5
82108	1/1	150	19,5	53 x 32,5
82110	1/1	200	26,0	53 x 32,5
	GN	↓ mm	ltr.	cm
82112	1/2	65	3,9	32,5 x 26,5
82114	1/2	100	5,9	32,5 x 26,5
82116	1/2	150	8,9	32,5 x 26,5
82117	1/2	200	11,8	32,5 x 26,5
	GN	↓ mm	ltr.	cm
82118	1/3	65	2,4	32,5 x 17,5
82120	1/3	100	3,6	32,5 x 17,5
82122	1/3	150	5,3	32,5 x 17,6
82123	1/3	200	7,0	32,5 x 17,6



### GN-Deckel

GN-lid  
GN tapa  
GN couvercle

PP



	GN	cm	cm
82101	1/1	1,5	53,0 x 32,5
82113	1/2	1,5	32,5 x 26,5
82119	1/3	1,5	32,5 x 17,6

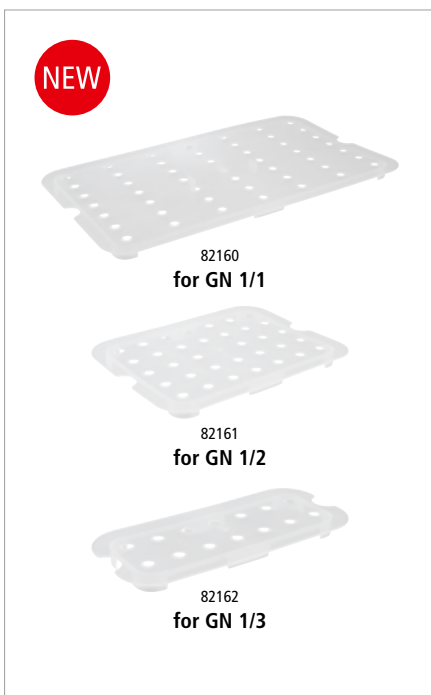

### GN Abtropfgitter

GN drainer  
GN escurridor  
GN égouttoir

PP



**feine Lochung für effizientes Abtropfen, Abstandshalter zum Behälterboden verhindern, dass Lebensmittel in Flüssigkeit liegen**

Fine perforations for efficient draining, spacers on the container base prevent food from lying in liquid

Perforaciones finas para un drenaje eficaz, los separadores en la base del recipiente evitan que los alimentos queden sumergidos en el líquido

Perforations fines pour un drainage efficace, des entretoises au fond du récipient empêchent les aliments de rester dans le liquide

	cm	cm	for GN
82160	47,3 x 26,8	2	1/1
82161	26,8 x 20,8	2	1/2
82162	26,8 x 11,8	2	1/3



MIX  
Papier | Fördert  
gute Waldnutzung  
FSC® C106855



#### DE Impressum

Herausgeber: Assheuer + Pott GmbH & Co. KG, Talweg 11, 59846 Sundern, Tel. +49 2933 97350, [info@aps-germany.de](mailto:info@aps-germany.de), [www.aps-germany.de](http://www.aps-germany.de)  
Gestaltung: Assheuer + Pott GmbH & Co. KG · Druck: Vormann Druck & Verlag GmbH, Im Braukhausiepen 3, 58802 Balve  
Wir behalten uns das Recht vor, die angegebenen Spezifikationen jederzeit zu ändern. Irrtum, Druckfehler und technische Änderungen vorbehalten.  
Artikelbeschreibungen sowie Abbildungen und Fotodarstellungen sind ohne Gewähr. Alle Angebote ohne Dekoration.  
Alle Preise verstehen sich unverbindlich (UVP) in Euro zuzüglich der gesetzlichen Mehrwertsteuer.  
© 2026 – Jede Vervielfältigung dieses Katalogs, auch auszugsweise, bedarf der ausdrücklichen Genehmigung der Assheuer + Pott GmbH & Co. KG.  
Bildnachweis: Niklas Thiemann Fotodesign, Stoll GmbH – Studio für Fotografie, ZENITH Werbung & Fotografie GmbH & Co. KG, iStock, Envato Elements Pty Ltd.,  
Media Impression GmbH, MPB-Schnücker, track by track GmbH, stock.adobe.com, sieger design GmbH & Co. KG, CASA-Fotoatelier für Werbung GmbH & Co. KG

#### EN Imprint

Editor: Assheuer + Pott GmbH & Co. KG, Talweg 11, 59846 Sundern, Germany, Tel. +49 2933 97350, [info@aps-germany.de](mailto:info@aps-germany.de), [www.aps-germany.de](http://www.aps-germany.de)  
Design: Assheuer + Pott GmbH & Co. KG · Print: Vormann Druck & Verlag GmbH, Im Braukhausiepen 3, 58802 Balve, Germany  
We reserve the right to alter at any time the specifications stated without notice. Errors, printing error and technical changes reserved. Item description as well as images and illustrations are without guaranty. All offers are without decoration.  
All prices are without commitment (RRP) in Euro and exclude the legal VAT prescribed by law.  
© 2026 – This catalogue may not be reproduced in whole or in part unless specific prior written authorization of Assheuer + Pott GmbH & Co. KG.  
Picture credits: Niklas Thiemann Fotodesign, Stoll GmbH – Studio für Fotografie, ZENITH Werbung & Fotografie GmbH & Co. KG, iStock, Envato Elements Pty Ltd.,  
Media Impression GmbH, MPB-Schnücker, track by track GmbH, stock.adobe.com, sieger design GmbH & Co. KG, CASA-Fotoatelier für Werbung GmbH & Co. KG



buffet | tabletop | bar

Assheuer + Pott GmbH & Co. KG  
Talweg 11, 59846 Sundern / Germany

[aps-germany.de](http://aps-germany.de)

