



RESTAURANT  
HOTEL



We strongly believe in the uniqueness of the single individual. We do not want a homogeneous world, where everyone thinks alike.  
All we do is offer our customers the opportunity to stand out by becoming unique

We do all this starting from a family production tradition of over 70 years, made of craftsmanship of the highest quality and experience, combined with the most advanced technological solutions.

We produce unique and bespoke professional tools to suit your culinary art.

# Since 1947

Crediamo fermamente nell'unicità del singolo individuo. Non vogliamo un mondo omogeneo, dove tutti pensano allo stesso modo.  
Tutto quello che facciamo è offrire ai nostri clienti la possibilità di distinguersi, diventando unici.

Facciamo tutto questo partendo da una tradizione familiare produttiva di oltre 70 anni, fatta di artigianato ad altissima qualità ed esperienza, unito alle più avanzate soluzioni tecnologiche.

Produciamo articoli professionali unici e su misura, per soddisfare la vostra arte culinaria.

Mepra and  
Pininfarina have  
created STILE, a  
refined collection  
for the lovers of  
Italian beauty.  
We created a  
s e p a r a t e d  
catalog, only for  
this collection.

# STILE

*by pininfarina*

Dalla collabora-  
zione di Mepra e  
Pininfarina, nasce  
STILE, una  
c o l l e z i o n e  
raffinata e  
innovativa per gli  
amanti della  
bellezza italiana.  
A b b i a m o  
realizzato un  
catalogo a parte,  
solo per questa  
collezione.

## Icon of timeless beauty



Cisitalia, 1947: una scultura in movimento esposta permanentemente al MoMA di New York.

Cisitalia, 1947: a sculpture in movement Exposed at MoMA in New York.

The finishings  
and the colors in  
the following  
pages, are  
available for all  
the flatware  
models and for  
the serveware.

# Mepra Atelier

Le finiture ed i  
colori presenti  
nelle pagine  
seguenti, sono  
disponibili per  
tutti i modelli di  
posate e per tutto  
il vasellame.





Mirror



**O**

Oro  
Lucido



**ON**

Oro Nero  
Lucido



**B**

Bronzo  
Lucido



**C**

Champagne  
Lucido



**A**

Arcobaleno  
Lucido



**AR**

Argentato  
Lucido



Ice



**OI**

**ION**

**IB**

**IC**

**IA**

**ARI**

Oro  
Ice

Oro Nero  
Ice

Bronzo  
Ice

Champagne  
Ice

Arcobaleno  
Ice

Argentato  
Ice



# Peltro



**PO**

Oro  
Peltro

**PON**

Oro Nero  
Peltro

**PB**

Bronzo  
Peltro

**PC**

Champagne  
Peltro

**PA**

Arcobaleno  
Peltro

**PAR**

Argentato  
Peltro

**MEPRA**  
S. p. A.  
H & R D I V I S I O N

# Posate



## FLATWARE COUVERTS BESTECKE CUBIERTOS

- Gamma completa per ogni modello
  - Spessore elevato
  - Rebbi delle forchette lavorati internamente
  - Seghettatura lame passante per un taglio perfetto
- Each collection consists of an extensive range of pieces.
- Thick stainless steel.
- Fork tines are polished on all sides for a lifetime of performance.
- Knife blades have a micro-serration for an effortless cut.
- Chaque modèle est complet de toute les pièces nécessaires
- Épaisseur massifs
- Fourchons des fourchettes intérieurement travaillés
- Les couteaux possèdent la dentelure fin ouvragée pour une coupe facile
- Jedes Modell verfügt über eine komplette Bandbreite an Zusatzteilen
- Hohe Materialstärke
- Exakte, maschinell gefertigte Gabelzinken
- Genaue Ausbildung der Messerschneiden für einen perfekten Schnitt
- Cada modelo esta completo de todo lo necesario
- Espesor macizo
- Tenedores con púas pulidas internamente.
- Cuchillos con hoja sierra; corte perfecto

**MEPRA**  
S.p.A.





Mirror



Code	mm.	inch.
01	199	7 7/8
02	199	7 7/8
03	228	9
04	176	6 7/8
05	176	6 7/8
06	203	8
07	135	5 1/8
08	108	4 1/4
09	330	13
10	235	9 1/4
11	235	9 1/4
12	228	9
13	203	8
15	150	5 7/8
16	251	9 7/8
20	195	7 7/8
21	195	7 7/8
22	235	9 1/4
23	235	9 1/4
25	185	7 1/4
35	175	6 7/8
36	228	9
37	170	6 3/4
39	175	6 7/8
40	185	7 1/4
45	183	7 1/5

Coltelli disponibili anche con manico vuoto  
 Hollow handle knives available  
 Couteaux disponibles aussi avec un manche creux  
 Messer in Hohlheft-Ausführung erhältlich  
 Cuchillo disponible también en mango hueco



Code		mm.	inch.
01		201	7 7/8
02		201	7 7/8
03		230	9
04		180	7
05		177	7
06		202	8
07		139	5 1/2
08		110	4 1/3
09		304	12
10		243	9 5/8
11		243	9 5/8
15		145	5 3/4
16		243	9 5/8
20		210	8 1/4
21		192	7 1/2
22		243	9 1/2
23		243	9 1/2
25		201	8
35		180	7
36		227	9
37		164	6 1/2
39		180	7
40		175	6 7/8
45		203	8

Tutti i pezzi di questo modello sono realizzati in forgia  
 All pieces in this range are forged  
 Toutes les pièces de ce modèle sont forgées  
 Alle Teile dieses Modells sind geschmiedet.  
 Todas las piezas de este modelo son hechas en forgia

mm 9,0  
**ARIA**



Code	mm.	inch.
01	208	8 1/5
02	208	8 1/5
03	235	9 1/4
04	185	7 1/4
05	185	7 1/4
06	205	8
07	140	5 1/2
08	120	4 3/4
09	275	10 7/8
10	250	9 7/8
11	250	9 7/8
15	155	6 1/8
16	260	10 1/4
20	210	8 1/4
21	185	7 1/4
22	250	9 7/8
23	250	9 7/8
25	201	7 7/8
26	156	6 1/2
35	185	7 1/4
36	235	9 1/4
37	183	7 1/5
39	185	7 1/4
40	180	7
45	183	7 1/4

I coltelli appoggiano sulla lama  
 Knives may be set blade-down  
 Les couteaux peuvent être posés debout sur leurs lames  
 Durch das aussergewöhnliche Design, ist es möglich, die  
 jeweiligen Messer auch hochkant, also "auf der Klinge  
 stehend", abzustellen.  
 Los cuchillos pueden apoyarse sobre la hoja.

Tutti i pezzi di questo modello sono realizzati in forgia  
 All pieces in this range are forged  
 Toutes les pièces de ce modèle sont forgées  
 Alle Teile dieses Modells sind geschmiedet  
 Todas las piezas de este modelo son hechas en forja



Code	mm.	inch.
01	210	8 1/4
02	210	8 1/4
03	235	9 1/4
04	190	7 1/2
05	190	7 1/2
06	212	8 1/3
07	138	5 1/5
08	109	4 1/3
09	290	11 1/5
10	240	9 1/2
11	238	9 1/8
15	158	6 1/4
16	259	10 1/5
20	223	8 1/4
21	208	8 1/5
22	240	9 1/2
23	240	9 1/2
25	208	8 1/5
36	234	9 1/5
37	178	7
39	192	7 1/2
40	175	6 1/8

mm 4,0  
**ATENA**



Code	mm.	inch.
01	200	7 7/8
02	202	8
03	221	8 3/4
04	180	7
05	180	7
06	198	7 3/4
07	135	5 1/3
08	114	4 1/2
09	312	12 1/8
10	235	9 1/4
11	240	9 1/2
15	150	5 7/8
16	255	10
20	210	8 1/4
21	202	8
22	235	9 1/4
23	235	9 1/4
25	185	7 1/4
31	114	4 1/2
35	180	7
36	221	8 3/4
37	162	6 1/5
39	180	7
40	185	7 1/4



ICE



Code	mm.	inch.
01	210	8 1/4
02	208	8 1/5
03	235	9 1/4
04	190	7 1/2
05	188	7 1/5
06	212	8 1/3
07	138	5 1/5
08	109	4 1/3
09	285	11 1/5
10	240	9 1/2
11	238	9 1/6
15	157	6 1/7
16	256	10
20	220	8 1/3
21	208	8 1/6
22	240	9 1/2
23	240	9 1/2
25	198	7 1/5
26	158	6 1/5
35	182	7 1/6
36	233	9 1/6
37	181	7 1/6
40	173	6 1/5

mm 8,0

BALI



Code	mm.	inch.
01	204	8
02	204	8
03	246	9 2/3
04	175	6 7/8
05	175	6 7/8
06	220	8 2/3
07	135	5 1/3
08	111	4 1/8
09	313	12 1/2
10	253	10
11	253	10
12	245	9 2/3
13	220	8 2/3
15	154	6
16	241	9 1/2
20	207	8 1/7
21	207	8 1/7
22	253	10
23	253	10
26	164	6 1/2
35	175	6 7/8
36	245	9 2/3
37	169	6 2/3
39	175	6 7/8
40	187	7 1/8
45	192	7 1/2

Coltelli disponibili anche con manico vuoto  
 Hollow handle knives available  
 Couteaux disponibles aussi avec un manche creux  
 Messer in Hohlheft-Ausführung erhältlich  
 Cuchillo disponible también en mango hueco



Code	mm.	inch.
01	207	8 1/2
02	207	8 1/2
03	235	9 1/4
04	180	7
05	180	7
06	204	8
07	135	5 1/3
08	114	4 1/2
09	315	12 1/5
10	250	9 7/8
11	250	9 7/8
12	235	9 1/4
13	204	8
15	155	6
16	244	9 5/8
20	180	7
21	179	7
22	250	9 7/8
23	250	9 7/8
24	140	5 1/2
25	195	7 2/3
26	155	6 1/5
35	180	7
36	224	8 7/8
37	170	6 2/3
39	180	7
40	184	7 1/4
44	165	6 1/2
45	205	8

Coltelli disponibili anche con manico vuoto  
 Hollow handle knives available  
 Couteaux disponibles aussi avec un manche creux  
 Messer in Hohlheft-Ausführung erhältlich  
 Cuchillo disponible también en mango hueco









mm 3,0

**BOHEME**



Code	mm.	inch.
01	204	8
02	203	8
03	232	9 1/8
04	185	7 1/4
05	184	7 1/4
06	210	8 1/4
07	134	5 1/4
08	110	4 1/3
09	288	11 1/2
10	240	9 3/5
11	241	9 1/2
15	158	6 1/5
16	258	10
20	198	7 7/8
21	184	7 1/4
25	195	7 2/3
35	182	7 1/6
36	234	9 1/5
37	172	6 3/4



Code	mm.	inch.
01 	201	7 7/8
02 	201	7 7/8
03 	232	9 1/8
04 	170	6 2/3
05 	175	6 7/8
06 	199	7 7/8
07 	133	5 1/4
08 	110	4 1/3
10 	250	9 5/8
11 	255	10
15 	152	6
20 	210	8 1/4
21 	201	7 7/8
22 	250	9 5/8
23 	250	9 5/8
25 	195	7 3/4
26 	155	6 1/8
36 	224	8 7/8
37 	171	6 3/4
39 	170	6 2/3
45 	182	7 1/8

mm 4,0  
**DIAMANTE**



Code	mm.	inch.
01	206	8 1/8
02	206	8 1/8
03	240	9 4/5
04	178	7
05	178	7
06	214	8 4/5
07	133	5 1/4
08	113	4 4/5
09	315	12 4/5
10	245	9 7/8
11	245	9 7/8
12	240	9 4/5
13	214	8 4/5
15	155	6
16	241	9 1/2
20	210	8 3/4
21	206	8 1/8
22	240	9 4/5
23	244	9 5/8
25	208	8 1/8
26	156	6 1/8
35	178	7
36	240	8 4/5
37	169	6 5/8
39	178	7
40	183	7 1/8
45	177	7



PELTRO

Coltelli disponibili anche con manico vuoto  
 Hollow handle knives available  
 Couteaux disponibles aussi avec un manche creux  
 Messer in Hohlheft-Ausführung erhältlich  
 Cuchillo disponible también en mango hueco



Code	mm.	inch.
01	200	7 7/8
02	200	7 7/8
03	225	8 7/8
04	175	6 7/8
05	180	7
06	200	7 7/8
07	135	5 1/3
08	110	4 1/3
09	298	11 3/4
10	235	9 1/4
11	245	9 5/8
15	150	6
16	252	10
20	185	7 1/4
21	185	7 1/4
22	235	9 1/4
23	235	9 1/4
25	185	7 1/4
35	180	7
36	225	8 7/8
37	193	7 5/8
39	178	7
40	180	7
45	189	7 4/5

- ICE
- ORO  
ICE
- ORO  
NERO
- BRONZO
- CHAMPAGNE
- ARCOBALENO

mm 4,0  
**DUE**



Code		mm.	inch.
01		205	8
02		206	8 1/8
03		235	9 1/4
04		175	6 7/8
05		175	6 7/8
06		202	8
07		134	5 1/4
08		111	4 1/3
09		302	11 7/8
10		231	9
11		233	9 1/8
15		157	6 1/8
16		241	9 1/2
20		184	7 1/4
21		175	6 7/8
22		231	9
23		231	9
25		195	7 3/8
36		235	9 1/4
37		175	6 7/8
39		175	6 7/8
40		173	6 7/8



Code		mm.	inch.
01		203	8
02		200	7 7/8
03		220	8 2/3
04		178	7
05		185	7 1/4
06		195	7 2/3
07		135	5 1/3
08		113	4 1/2
09		310	12 1/2
10		245	9 2/3
11		241	9 1/2
15		150	5 7/8
16		255	10
20		197	7 3/4
21		185	7 1/3
22		245	9 2/3
23		245	9 2/3
25		201	8
35		178	7
36		220	8 2/3
37		195	7 2/3
39		178	7
40		180	7

mm 4,0  
**ENERGIA**



Code	mm.	inch.
01	209	8 1/5
02	209	8 1/5
03	240	9 1/2
04	180	7
05	180	7
06	214	8 2/5
07	136	5 1/5
08	114	4 1/2
09	315	12 2/5
10	250	9 7/8
11	250	9 7/8
12	240	9 1/2
13	214	8 2/5
15	155	6
16	243	9 1/2
20	210	8 1/4
21	207	8 1/7
22	250	9 7/8
23	250	9 7/8
25	194	7 2/5
26	155	6 1/5
35	190	7 1/2
36	227	9
37	172	6 3/4
39	180	7
40	184	7 1/4
44	165	6 1/2
45	208	8 1/6



Coltelli disponibili anche con manico vuoto  
 Hollow handle knives available  
 Couteaux disponibles aussi avec un manche creux  
 Messer in Hohlheft-Ausführung erhältlich  
 Cuchillo disponible también en mango hueco



Code		mm.	inch.
01		205	8
02		200	7 7/8
12		215	8 1/2
04		193	7 1/2
05		178	7
13		192	7 1/2
07		138	5 1/2
09		293	11 1/2
10		249	9 1/2
11		249	9 1/2
15		172	6 3/4
16		252	10
20		211	8 1/2
21		204	8
40		201	7 7/8



Angelo Mangiarotti

Posata realizzata a manico vuoto.  
 Hollow handle manufactured cutlery.  
 Couvert réalisée avec les manches vides.  
 Bestecke in Hohlheft-Ausführung  
 verarbeitet.  
 Cubierto hecha en mango hueco.

# ERGONOMICA

1322



Code	mm.	inch.
01	210	8 1/4
02	210	8 1/4
03	234	9 1/5
04	190	7 1/2
05	187	7 1/3
06	208	8 1/5
07	142	5 1/5
08	120	4 1/4
09	300	11 1/5
10	255	10
11	250	9 1/6
15	160	6 1/3
16	280	11
20	212	8 1/3
21	186	7 1/3
22	255	10
23	255	10
25	195	7 1/3
35	188	7 1/5
36	234	9 1/5
37	198	7 1/5
39	190	7 1/2
40	191	7 1/2
45	193	7 1/5

I coltelli appoggiano sulla lama  
 Knives may be set blade-down  
 Les couteaux peuvent être posés debout sur leurs lames  
 Durch das aussergewöhnliche Design, ist es möglich, die  
 jeweiligen Messer auch hochkant, also "auf der Klinge  
 stehend", abzustellen.  
 Los cuchillos pueden apoyar sobre la hoja.

Tutti i pezzi di questo modello sono realizzati in forgia  
 All pieces in this range are forged  
 Toutes les pièces de ce modèle sont forgées  
 Alle Teile dieses Modells sind geschmiedet  
 Todas las piezas de este modelo son hechas en forgia



Code		mm.	inch.
01		214	8 1/5
02		214	8 1/5
03		247	9 3/4
04		189	7 1/5
05		189	7 1/5
06		218	8 1/5
07		144	5 1/3
08		116	4 1/2
09		300	11 1/5
10		256	10
11		256	10
15		156	6 1/7
16		274	10 3/4
20		212	8 1/3
21		189	7 1/5
22		256	10
23		256	10
36		247	9 3/4
37		218	8 1/5
44		165	6 1/2



ADV  
Astier de Villatte

mm 3,0  
**GINEVRA**



Code	mm.	inch.
01	195	7 7/8
02	195	7 7/8
03	218	8 5/8
04	173	6 7/8
05	173	6 7/8
06	195	7 7/8
07	130	5 1/8
08	112	4 3/8
09	299	11 3/4
10	234	9 1/5
11	234	9 1/5
15	154	6
16	251	9 7/8
20	197	7 3/4
21	195	7 7/8
22	234	9 1/5
23	234	9 1/5
25	185	7 1/2
35	175	6 7/8
36	218	8 5/8
37	153	6
39	173	6 7/8
40	184	7 1/4









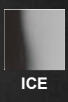

Code	mm.	inch.
01 	202	8
02 	202	8
03 	231	9
04 	176	6 1/5
05 	176	6 1/5
06 	204	8
07 	138	5 1/5
08 	106	4 1/6
09 	330	13
10 	235	9 1/4
11 	235	9 1/4
15 	150	5 1/5
16 	251	9 1/5
20 	202	8
21 	202	8
22 	235	9 1/4
23 	235	9 1/4
25 	185	7 1/4
36 	210	8 1/4
37 	185	7 1/4
39 	182	7 1/6
40 	185	7 1/4

mm 4,0  
**IMMAGINA**



Code		mm.	inch.
01		203	8
02		203	8
03		210	8 1/4
04		177	7
05		177	7
06		190	7 1/2
07		133	5 1/4
08		113	4 1/5
09		308	12 1/8
10		237	9 1/3
11		237	9 1/3
15		157	6 1/6
16		248	9 1/4
18		241	9 1/2
20		203	8
21		203	8
22		237	9 1/3
23		237	9 1/3
24		134	5 1/4
25		185	7 1/4
35		177	7
37		177	7
39		177	7
40		187	7 1/3
45		177	7



Code		mm.	inch.
01		207	8 1/7
02		201	7 7/8
03		219	8 3/5
04		178	7
07		134	5 1/4
08		120	4 3/4
15		135	5 1/3
21		210	8 1/4

Arch. Katja Bremkamp

The asymmetrical and rather unfamiliar shape of this cutlery range was influenced by the way we handle certain situations relating to the table routine. I was looking at the movements of the hands when dishing food out of bowls, when serving onto a plate and how this movement alters when food is conveyed into the mouth. Each piece reflects these movements individually, referring to their purposes and their "actions", as some pieces are more asymmetrical than others. The overall asymmetrical shape of this range therefore supports the comfortable handling of cutlery and also acts as guide to the person who is using it.

La forma asimmetrica e non convenzionale di questo modello è stata influenzata dall'osservazione dei comportamenti e delle routine legate al consumo del cibo a tavola. Ho guardato i movimenti delle mani durante la disposizione del cibo sul piatto, la raccolta del boccone e l'accompagnamento alla bocca. Ogni pezzo riflette individualmente questi movimenti, riferendosi al loro scopo e alle loro azioni; questo spiega il motivo per cui alcuni pezzi sono più asimmetrici di altri. Oltretutto, l'asimmetria di questa linea avvantaggia la maneggevolezza della posata in modo da guidare la persona che la usa.



ICE

mm 3,0  
**KATJA**



Code	mm.	inch.
01	208	8 1/5
02	208	8 1/5
03	235	9 1/4
04	180	7
05	180	7
06	210	8 1/4
07	133	5 1/4
08	115	4 1/2
09	315	12 1/5
10	248	9 3/4
11	245	9 2/3
12	235	9 1/4
13	210	8 1/4
15	156	6 1/2
16	242	9 1/2
20	210	8 1/4
21	210	8 1/4
22	248	9 3/4
23	248	9 3/4
24	134	5 1/4
25	205	8
26	156	6 1/2
35	180	7
36	235	9 1/4
37	170	6 2/3
39	180	7
40	185	7 1/4
44	175	6 2/3
45	180	7

Coltelli disponibili anche con manico vuoto  
 Hollow handle knives available  
 Couteaux disponibles aussi avec un manche creux  
 Messer in Hohlheft-Ausführung erhältlich  
 Cuchillo disponible también en mango hueco

# LEONARDO mm 4,0



Code		mm.	inch.
01		205	8
02		205	8
03		233	9 1/6
04		179	7
05		179	7
06		200	7 7/8
07		135	5 1/3
08		113	4 3/5
09		316	12 1/5
10		239	9 3/5
11		245	9 3/3
15		160	6 1/3
16		244	9 3/5
20		205	8
21		208	8 1/5
22		239	9 3/5
23		239	9 3/5
25		201	8
26		158	6 1/5
35		155	6 1/9
36		233	9 1/6
37		163	6 3/5
39		179	7
40		182	7 1/6
45		179	7



ICE

Maurizio Durante

mm 3,5  
**LEVANTINA**



Code	mm.	inch.
01	200	7 7/8
02	203	8
03	235	9 1/4
04	178	7
05	180	7
06	205	8
07	135	5 1/3
08	115	4 1/2
09	305	12
10	245	9 2/3
11	245	9 2/3
15	150	6
16	246	9 2/3
20	200	7 7/8
21	187	7 1/2
22	245	9 2/3
23	245	9 2/3
25	185	7 1/3
35	178	7
36	235	9 1/4
37	178	7
39	178	7
40	190	7 1/2

- ICE
- ORO ICE
- ORO NERO
- BRONZO
- CHAMPAGNE
- ARCOBALENO

Coltelli disponibili anche con manico vuoto  
 Hollow handle knives available  
 Couteaux disponibles aussi avec un manche creux  
 Messer in Hohlheft-Ausführung erhältlich  
 Cuchillo disponible también en mango hueco

Code	mm.	inch.
01	208	8 1/5
02	208	8 1/5
03	224	8 2/5
04	183	7 1/5
05	183	7 1/5
06	195	7 2/5
07	135	5 1/5
08	115	4 1/2
09	293	11 1/2
10	265	10 2/5
11	265	10 2/5
12	224	8 2/5
13	195	7 2/5
15	152	6
16	257	10 1/5
20	223	8 3/4
21	209	8 1/5
22	265	10 2/5
23	265	10 2/5
25	201	8
26	152	6
35	183	7 1/5
36	224	8 2/5
37	171	6 3/4
39	183	7 1/5
40	180	7



ICE

**Diciottesimo  
 Premio Compasso d'Oro  
 ADI**

Mediterranea  
 Posate  
**Maurizio Duranti**  
 Designer  
**Mepra spa**  
 Produttore

**Selezione d'onore  
 Compasso d'Oro  
 ADI 1998**

























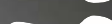

mm 3,5  
**MEDITERRANEA**



Code	mm.	inch.
01	209	8 1/5
02	209	8 1/5
03	235	9 1/4
04	180	7
05	180	7
06	215	8 2/5
07	136	5 1/5
08	114	4 1/2
09	315	12 1/5
10	250	9 5/6
11	250	9 5/6
12	235	9 1/4
13	204	8
15	155	6 1/5
16	243	9 1/2
18	253	10
19	251	9 5/6
20	210	8 1/4
21	207	8 1/7
22	250	9 5/6
23	250	9 5/6
24	140	5 1/2
25	195	7 2/5
26	155	6 1/5
35	190	7 1/2
36	224	8 5/6
37	170	6 2/5
39	180	7
40	184	7 1/4
44	165	6 1/2
45	208	8 1/6

Coltelli disponibili anche con manico vuoto  
 Hollow handle knives available  
 Couteaux disponibles aussi avec un manche creux  
 Messer in Hohlheft-Ausführung erhältlich  
 Cuchillo disponible también en mango hueco



Code	mm.	inch.
01 	211	8 1/5
02 	211	8 1/5
03 	239	9 1/5
04 	181	7 1/8
05 	181	7 1/8
06 	215	8 1/5
07 	135	5 1/3
08 	114	4 1/2
09 	314	12 1/5
10 	250	9 1/6
11 	250	9 1/6
15 	158	6 1/5
16 	241	9 1/2
20 	213	8 1/5
21 	211	8 1/5
22 	250	9 1/6
23 	250	9 1/6
25 	201	8
26 	159	6 1/4
35 	189	7 1/5
36 	235	9 1/4
37 	174	6 1/8
39 	189	7 1/5
40 	190	7 1/2
45 	189	7 1/5
49 	149	5 1/8

mm 4,0  
**MORETTO**



Code	mm.	inch.
01 	201	8
02 	201	8
03 	219	8 <sup>1</sup> / <sub>5</sub>
04 	180	7
05 	180	7
06 	195	7 <sup>1</sup> / <sub>3</sub>
07 	140	5 <sup>1</sup> / <sub>2</sub>
08 	113	4 <sup>1</sup> / <sub>5</sub>
09 	320	12 <sup>1</sup> / <sub>5</sub>
10 	245	9 <sup>1</sup> / <sub>3</sub>
11 	245	9 <sup>1</sup> / <sub>3</sub>
15 	153	6
16 	256	10
20 	213	8 <sup>1</sup> / <sub>5</sub>
21 	206	8 <sup>1</sup> / <sub>3</sub>
22 	245	9 <sup>1</sup> / <sub>3</sub>
23 	245	9 <sup>1</sup> / <sub>3</sub>
25 	201	8
35 	180	7
36 	219	8 <sup>1</sup> / <sub>5</sub>
37 	195	7 <sup>1</sup> / <sub>3</sub>
39 	180	7
40 	190	7 <sup>1</sup> / <sub>2</sub>

Giulio Iacchetti

Code		mm.	inch.
01		200	7 7/8
02		204	8
03		230	9
04		180	7
05		180	7
06		204	8
07		135	5 1/3
08		113	4 4/5
09		310	12 1/5
10		240	9 1/2
11		245	9 2/3
15		150	5 5/8
16		252	10
20		222	8 3/4
21		203	8
22		240	9 1/2
23		240	9 1/2
25		201	8
35		180	7
36		230	9
37		204	8
39		180	7
40		180	7



I coltelli appoggiano sulla lama  
 Knives may be set blade-down  
 Les couteaux peuvent être posés debout sur leurs lames  
 Durch das aussergewöhnliche Design, ist es möglich, die jeweiligen Messer auch hochkant, also "auf der Klinge stehend", abzustellen.  
 Los cuchillos pueden apoyar sobre la hoja

mm 4,0  
**MOVIDA**

Code	mm.	inch.
01	201	7 7/8
02	201	7 7/8
03	232	9 1/8
04	170	6 2/3
05	175	6 7/8
06	199	7 7/8
07	133	5 1/4
08	110	4 1/3
09	314	12 1/3
10	250	9 7/8
11	255	10
12	232	9 1/8
13	199	7 7/8
15	152	6
16	245	9 3/4
20	170	6 2/3
21	173	6 7/8
22	250	9 7/8
23	250	9 7/8
25	195	7 3/4
26	155	6 1/8
35	175	6 7/8
36	224	8 7/8
37	171	6 3/4
39	170	6 2/3
40	190	7 1/2
45	182	7 1/8



ICE

Coltelli disponibili anche con manico vuoto  
 Hollow handle knives available  
 Couteaux disponibles aussi avec un manche creux  
 Messer in Hohlheft-Ausführung erhältlich  
 Cuchillo disponible también en mango hueco



Code	mm.	inch.
01 	210	8 <sup>1</sup> / <sub>4</sub>
02 	208	8 <sup>1</sup> / <sub>5</sub>
03 	236	9 <sup>1</sup> / <sub>4</sub>
04 	188	7 <sup>1</sup> / <sub>5</sub>
05 	190	7 <sup>1</sup> / <sub>2</sub>
06 	214	8 <sup>1</sup> / <sub>5</sub>
07 	138	5 <sup>1</sup> / <sub>5</sub>
08 	109	4 <sup>1</sup> / <sub>3</sub>
09 	285	11 <sup>1</sup> / <sub>5</sub>
10 	240	9 <sup>1</sup> / <sub>2</sub>
11 	238	9 <sup>1</sup> / <sub>8</sub>
12 	230	9
15 	158	6 <sup>1</sup> / <sub>5</sub>
16 	259	10 <sup>1</sup> / <sub>5</sub>
20 	224	8 <sup>1</sup> / <sub>5</sub>
21 	208	8 <sup>1</sup> / <sub>6</sub>
22 	240	9 <sup>1</sup> / <sub>2</sub>
23 	240	9 <sup>1</sup> / <sub>2</sub>
25 	198	7 <sup>1</sup> / <sub>5</sub>
26 	159	6 <sup>1</sup> / <sub>4</sub>
35 	183	7 <sup>1</sup> / <sub>5</sub>
36 	244	9 <sup>1</sup> / <sub>8</sub>
37 	180	7
40 	172	6 <sup>1</sup> / <sub>4</sub>

mm 4,5  
**NEVE**



Coltelli disponibili anche con manico vuoto  
 Hollow handle knives available  
 Couteaux disponibles aussi avec un manche creux  
 Messer in Hohlheft-Ausführung erhältlich  
 Cuchillo disponible también en mango hueco

Code	mm.	inch.
01	205	8
02	205	8
03	230	9
04	175	6 <sup>7</sup> / <sub>8</sub>
05	175	6 <sup>7</sup> / <sub>8</sub>
06	203	8
07	133	5 <sup>1</sup> / <sub>4</sub>
08	112	4 <sup>1</sup> / <sub>5</sub>
09	310	12 <sup>1</sup> / <sub>5</sub>
10	254	10
11	255	10
12	230	9
13	203	8
15	152	6
16	243	9 <sup>5</sup> / <sub>8</sub>
20	206	8 <sup>1</sup> / <sub>8</sub>
21	206	8 <sup>1</sup> / <sub>8</sub>
22	254	10
23	254	10
24	135	5 <sup>1</sup> / <sub>8</sub>
25	195	7 <sup>5</sup> / <sub>8</sub>
26	160	6 <sup>1</sup> / <sub>8</sub>
27	160	6 <sup>1</sup> / <sub>8</sub>
28	180	7
35	175	6 <sup>7</sup> / <sub>8</sub>
36	233	9 <sup>1</sup> / <sub>6</sub>
37	171	6 <sup>3</sup> / <sub>4</sub>
39	175	6 <sup>7</sup> / <sub>8</sub>
40	188	7 <sup>3</sup> / <sub>8</sub>
44	165	6 <sup>1</sup> / <sub>2</sub>
45	175	6 <sup>7</sup> / <sub>8</sub>



Code		mm.	inch.
01		197	7 7/8
02		197	7 7/8
03		223	8 7/8
04		174	6 7/8
05		175	6 7/8
06		197	7 7/8
07		133	5 1/4
10		235	9 1/4
11		235	9 1/4
15		157	6 1/8
16		254	10
22		233	9 1/8
23		233	9 1/8
20		198	7 7/8
21		195	7 3/8
26		156	6 1/8
40		185	7 1/4

mm 3,0  
**OFFICINA**

05



Code	mm.	inch.
01	207	8 1/2
02	207	8 1/2
03	236	9 1/4
04	179	7
05	179	7
06	213	8 2/5
07	134	5 1/4
08	113	4 2/5
09	300	11 1/5
10	248	9 3/4
11	248	9 3/4
15	155	6 1/8
16	257	10 1/5
20	179	7
21	179	7
22	248	9 3/4
23	248	9 3/4
25	195	7 2/3
26	155	6
35	175	6 2/5
36	227	9
37	172	6 3/4
39	170	6 2/3
40	180	7
45	179	7



Code	mm.	inch.
01	209	8 1/5
02	209	8 1/5
03	235	9 1/4
04	180	7
05	180	7
06	204	8
07	136	5 1/3
08	114	4 1/2
09	315	12 1/5
10	250	9 7/8
11	250	9 7/8
12	235	9 1/4
13	204	8
15	155	6
16	243	9 1/2
20	210	8 1/4
21	207	8 1/7
22	250	9 7/8
23	250	9 7/8
25	195	7 1/3
26	155	6 1/3
35	190	7 1/2
36	235	9 1/4
37	170	6 1/3
39	180	7
40	184	7 1/4
44	165	6 1/2
45	180	7

Coltelli disponibili anche con manico vuoto  
 Hollow handle knives available  
 Couteaux disponibles aussi avec un manche creux  
 Messer in Hohlheft-Ausführung erhältlich  
 Cuchillo disponible también en mango hueco

mm 4,0 **RAFFAELLO**



Code	mm.	inch.
01	205	8
02	205	8
03	236	9 1/3
04	180	7
05	180	7
06	200	7 7/8
07	135	5 1/3
08	115	4 1/2
09	320	12 1/5
10	250	9 7/8
11	250	9 7/8
12	236	9 1/3
13	200	7 7/8
15	155	6 1/8
16	242	9 1/2
20	180	7
21	180	7
22	250	9 7/8
23	250	9 7/8
25	195	7 1/3
26	155	6 1/8
35	180	7
36	224	8 7/8
37	170	6 2/3
39	180	7
40	185	7 1/4
44	165	6 1/2
45	208	8 1/8

Coltelli disponibili anche con manico vuoto  
 Hollow handle knives available  
 Couteaux disponibles aussi avec un manche creux  
 Messer in Hohlheft-Ausführung erhältlich  
 Cuchillo disponible también en mango hueco



Code	mm.	inch.
01	204	8
02	204	8
03	239	9 1/5
04	175	6 7/8
05	175	6 7/8
06	203	8
07	133	5 1/4
08	109	4 1/3
09	313	12 1/2
10	232	9 1/8
11	232	9 1/8
12	239	9 1/5
13	203	8
15	156	6 1/7
16	244	9 3/5
18	242	9 1/2
19	240	9 1/5
20	206	8 1/8
21	203	8
22	232	9 1/8
23	232	9 1/8
24	134	5 1/4
25	207	8 1/7
26	159	6 1/4
35	190	7 1/2
36	239	9 1/5
37	180	7
39	175	6 7/8
40	188	7 1/5
45	208	8 1/5

Coltelli disponibili anche con manico vuoto  
 Hollow handle knives available  
 Couteaux disponibles aussi avec un manche creux  
 Messer in Hohlheft-Ausführung erhältlich  
 Cuchillo disponible también en mango hueco

mm 4,0  
**SOLE**



Code	mm.	inch.
01	208	8 1/5
02	208	8 1/5
03	234	9 1/5
04	185	7 1/4
05	183	7 1/5
06	208	8 1/5
07	138	5 2/5
08	109	4 1/3
09	317	12 1/2
10	240	9 1/2
11	245	9 2/3
15	157	6 1/5
16	240	9 1/2
20	182	7 1/6
21	175	6 2/3
22	240	9 1/2
23	240	9 1/2
25	185	7 1/4
40	175	6 2/3



Code		mm.	inch.
01		203	8
02		202	8
03		232	9 1/8
04		181	7 1/8
05		180	7
06		204	8
07		138	5 3/5
08		115	4 1/2
09		285	11 1/5
10		246	9 2/5
11		244	9 3/8
15		151	6
16		248	9 3/4
20		200	7 7/8
21		179	7
22		245	9 2/5
23		245	9 2/5
35		178	7
36		232	9 1/8
37		178	7
39		182	7 1/8
45		184	7 1/4

mm 3,0  
**STIRIA**



Code		mm.	inch.
01		204	8
02		201	7 1/8
03		231	9
04		184	7 1/4
05		182	7 1/5
06		209	8 1/5
07		135	5 1/3
08		110	4 1/3
09		280	11
10		231	9
11		234	9 1/5
15		153	6
16		260	10 1/4
20		197	7 3/4
21		201	7 1/5
25		185	7 1/3
35		178	7
36		230	9
37		172	6 1/4

Giulio Iacchetti



Code	mm.	inch.
01	200	7 7/8
02	200	7 7/8
03	211	8 1/3
04	177	7
05	177	7
06	189	7 1/2
07	135	5 1/3
08	112	4 1/5
09	295	11 3/5
10	240	9 1/2
11	240	9 1/2
13	189	7 1/2
15	150	5 7/8
16	256	10
20	215	8 3/5
21	199	7 7/8
22	240	9 1/2
23	240	9 1/2
25	201	8
37	189	7 1/2
39	177	7
40	183	7 1/5

Coltelli disponibili anche con manico vuoto  
Hollow handle knives available  
Couteaux disponibles aussi avec un manche creux  
Messer in Hohlheft-Ausführung erhältlich  
Cuchillo disponible también en mango hueco

mm 3,0  
**SVEVA**





I modelli delle due pagine seguenti, sono già disponibili in magazzino nella versione satinata, ICE. Tutti gli altri modelli possono essere forniti in versione ICE, a richiesta, senza quantità minima

The models on the two following pages are already available in stock in the satin ICE version. All the other models can be supplied on request in the ICE version, without minimum quantity.

Les modèles des deux pages suivantes sont déjà disponible en stock dans la version avec la surface de fin brossée, ICE. Tous les autres modèles peuvent être fournis en version ICE, sur demande, sans quantité minimum.

Die Modelle auf den folgenden zwei Seiten sind Ausführungen in der matte, gebürstete ICE Oberfläche auf Lager bereits. Alle anderen Modelle können auf Anfrage ohne Mindestmenge in der ICE-Version geliefert werden

Los modelos de las dos páginas siguientes sonya disponible en el almacén en la versión ICE, con la superficie satinada. Todos los otros modelos se pueden suministrar en la versión ICE, bajo pedido, sin cantidad mínima.

# Ice



45 DUE ICE



41 ITALIA ICE



39 LEVANTINA ICE



47 LINEA ICE



57 GINEVRA ICE



42 NATURA ICE



40 MEDITERRANEA ICE



53 AVANGUARDIA ICE



# Peltro





mm 3,0

70P CARINZIA PELTRO



mm 3,0

71P STOCCOLMA PELTRO



mm 4,0

69 EPOQUE PELTRO



mm 4,0

27 DOLCE VITA PELTRO

I modelli di queste pagine, sono già disponibili in magazzino nella versione antichizzata, PELTRO. Tutti gli altri modelli possono essere forniti in versione PELTRO, a richiesta, senza quantità minima

The models on this pages are already available in stock in the antiqued PELTRO version. All the other models can be supplied on request in the PELTRO version, without minimum quantity.







Oro



DESIGNPREIS  
2009

## NOMINEE

La speciale finitura non è ottenuta con metodi tradizionali come verniciatura o bagno galvanico, ma con un processo di impiantazione molecolare a base di titanio, frutto della ricerca aerospaziale.

Il prodotto è garantito per il lavaggio in lavastoviglie, non si macchia, non si ossida e resiste alla corrosione.

Unlike products that are coated or made with a galvanic process, our's is obtained using a titanium based molecular embedding process originally developed through aerospace research.

The product is dishwasher-safe, will not stain or oxidize and is highly resistant to corrosion.

Le produit n'est pas enduit ou fait avec un processus galvanique, Il est obtenu avec un processus à base de titane de d'implantation Moléculaire qui est le résultat de la recherche aérospatiale.

Le produit passe au lave-vaisselle, ne rouille pas ou ne s'oxyde pas et ne marque pas.

Die hier und vorher abgebildeten Bestecke, die mit einer Oberfläche aus Titan versehen sind, haben exakt die Farbe von Gold (ORO ICE), tiefem Schwarz (ORO NERO) und Bronze (BRONZO), was der Gestaltung von Tischen und Wohnräumen völlig neue Akzente verleiht. Das angewendete Veredelungsverfahren (P.V.D.) kommt aus der Raumfahrttechnik und war bisher bei der Gestaltung von Tabletop-Artikeln noch nie nicht angewendet worden bzw. völlig unbekannt.

Diese Produkte haben Dank des Titans eine 4 mal so harte Oberfläche wie Edelstahl, sehen nicht nur schön aus, sondern sind absolut robust und für den täglichen Gebrauch bestens geeignet.

Anfang des Jahres 2008 bekamen die Besteckmodell den begehrten Designpreis "Design Plus 2008" verliehen

El acabado especial no se obtiene de métodos tradicionales como barnizados o baño galvanico, se obtiene mediante un proceso de implantación molecular a base de titanio, fruto de la búsqueda aeroespacial.

El producto esta garantizado para el lavado en lava-vajillas, no se mancha, no se oxida y es resistente a la corrosión.



88 DUE ORO



89 LINEA ORO

I modelli di queste pagine, sono già disponibili in magazzino nella versione Oro. Tutti gli altri modelli possono essere forniti in versione Oro, a richiesta, senza quantità minima

The models on this pages are already available in stock in the Gold version. All the other models can be supplied on request in the Gold version, without minimum quantity.

Les modèles des cettés pages sont déjà disponible en stock dans la version Oro. Tous les autres modèles peuvent être fournis en version Oro, sur demande, sans quantité minimum.

Die Modelle auf diesei Seiten sind Ausführungen in der Oro, Oberfläche auf Lager bereits. Alle anderen Modelle können auf Anfrage ohne Mindestmenge in der Oro-Version geliefert werden

Los modelos de estas páginas son ya disponible en el almacén en la versión Oro. Todos los otros modelos se pueden suministrar en la versión Oro, bajo pedido, sin cantidad mínima.





92 DUE CHAMPAGNE



86 DUE ORO NERO



93 LINEA CHAMPAGNE



87 LINEA ORO NERO





90 DUE BRONZO



80 DUE ICE ORO



91 LINEA BRONZO



81 LINEA ICE ORO



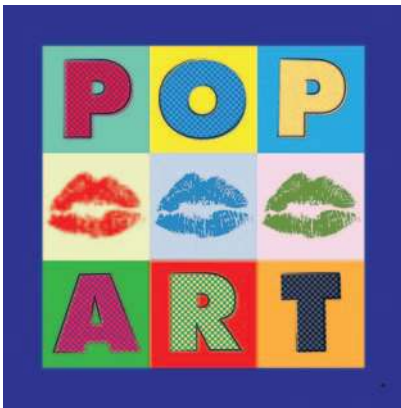

94 DUE ARCOBALENO



99 LINEA ARCOBALENO



# Collezione





**40**

Mestolino per Salsa  
Gravy ladle  
Cuillère à sauce  
Saucenöffel  
Cacillo para salsaera

Si usa per servire  
salse e condimenti  
dalla salsiera  
It is used to take sau-  
ces and aromatic con-  
diments from the gravy  
boat.



**16**

Pala per Torta  
Cake trowel  
Pelle à tarte  
Tortenheber  
Pala tarta

Si usa per tagliare e  
servire torte e semi-  
freddi  
It is used to portion  
and serve cakes or  
"semifreddi" (some  
kinds of Italian ice-  
cream).

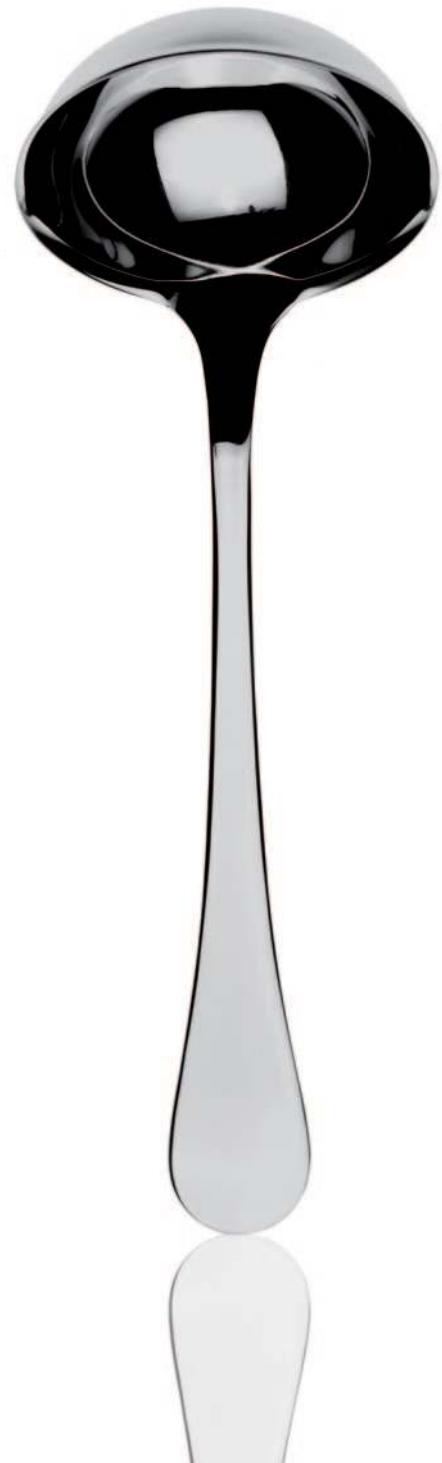

**09**

Mestolo a servire  
Ladle  
Louche  
Suppenschöpfer  
Cazo Sopa

Si usa per servire mine-  
stre dalla zuppiera al  
piatto fondo  
It's used to serve soups  
from the tureen to the  
(soup) plate.



01

Cucchiaio Tavola  
Table spoon  
Cuillère table  
Tafellöffel  
Cuchara de mesa

Cucchiaio per minestre e primi piatti  
Spoon for soups and first courses



04

Cucchiaio Frutta  
Dessert spoon  
Cuillère à dessert  
Dessertlöffel  
Cuchara postre

Cucchiaio per dessert a base di crema e salse. Molto utile anche per la prima colazione  
Spoon for cream or sweet sauce desserts, very helpful for breakfast too.



07

Cucchiaino Caffè  
Tea spoon  
Cuillère à café  
Kaffeelöffel  
Cuchara café

In realtà è un cucchiaino per tè e tisane, utilizzato anche per le zuccheriere e le formaggere. Dato i molteplici utilizzi, è sempre meglio possederne una mezza dozzina in più rispetto al resto della pezzeria.  
This is just a tea or herbal tea spoon, but is also used with sugar bowls and cheese basins. For this reason, it is better to have half of a dozen more than the rest of the cutlery.



08

Cucchiaino Moka  
Coffee spoon  
Cuillère à moka  
Mokkalöffel  
Cucharita moka

Cucchiaino per caffè  
This is a coffee spoon



10

Cucchiandone a servire  
Cooking spoon  
Cuillère à legumes/ à ragût  
Gemüselöffel  
Cuchara legumbres

Si usa per servire sia primi piatti sia piatti principali. Buona regola possederne in quantità doppia rispetto al forchettone  
It's used to serve first and main courses. It is better to have this cover twice than the cooking fork.



22

Cucchiaio Insalata  
Salad serving spoon  
Cuillère à salade servir  
Salatvorlegelöffel  
Cuchara servir ensalada

Si usa per mescolare e servire insalate, ma non solo: ottimo per servire antipasti a base di verdure e pesce. It is used to mix and serve salads, but is also very good to serve fish and vegetable hors-d'oeuvres.



23

Forchetta Insalata  
Salad serving fork  
Fourchette à salade servir  
Salatvorlegegabel  
Tenedor servir ensalada

Forchetta insalata  
Si usa in coppia con  
il cucchiaino insalata  
Salad serving fork  
It is used with the  
salad spoon for serving.



25

Cucchiaino Bibita  
Ice tea spoon  
Cuillère à soda  
Limonadenöffel  
Cucharita refresco

Cucchiaino per  
cocktail e gelati  
con creme in  
coppe profonde  
Spoon used for  
cocktails and  
ice-creams served  
in deep drinking-glasses.



44

Cucchiaino Cappuccino  
Cappuccino spoon  
Cuillère à cappuccino  
Cappuccinolöffel  
Cucharita cappuccino

Cucchiaino per  
cocktail e gelati  
con creme in  
coppe profonde  
Spoon used for  
cocktails and ice-  
creams served in  
deep drinking-glasses.



39

Cucchiaino Gourmet  
Gourmet spoon  
Cuillère à dégustation  
Kostprobelöffel  
Cuchara degustación

Cucchiaino per dolci  
e pesce con salse.  
La parte schiacciata  
della tazza,  
consente sia di tagliare  
la pietanza,  
che di raccoglierne  
il sugo.  
It's the spoon used  
for cakes and fish  
with sauce. The  
crushed part of the  
cup , allows both to  
cut the course and  
to collect the juice.



45

Cucchiaino Degustazione  
French sauce spoon  
Cuillère à sauce individuelle  
Gourmetlöffel  
Cuchara salsa gourmet

Paletta per pesce  
con salse, adatta a  
tagliare il pezzo ed  
a raccoglierne la  
salsa.  
Scoop for fish with  
sauces , used to  
cut the piece and  
to reap the sauce .



35

Cucchiaino Zuppa  
Soup spoon  
Cuillère à soupe  
Tassenlöffel rund  
Cuchara para sopa

Cucchiaino per consomme,  
tipica forma di cucchiaino  
per minestre in  
brodo della tradizione  
inglese.  
It's the consomme  
spoon used for the  
traditionals English  
soups.



26

Cucchiaino americano  
American coffee spoon  
Cuillère pour enfant  
Kinderlöffel  
Cucharita bebé

Cucchiaino per il  
caffè americano. il  
cappuccino, la  
prima colazione,  
oppure per dessert  
a base di creme e  
salse.  
Spoon used for  
american coffee,  
cappuccino , breakfast  
or for dessert with  
cream and sauces .



02

Forchetta Tavola  
Table fork  
Fourchette table  
Tafelgabel  
Tenedor de mesa

Forchetta per primi piatti e piatto principale. Dato che è il pezzo in assoluto più utile ed usato, è sempre meglio possederne in doppia quantità rispetto agli altri pezzi.  
Fork for first and main courses. It's better to have this cover twice, because it is the most useful one.



05

Forchetta Frutta  
Dessert fork  
Fourchette à dessert  
Dessertgabel  
Tenedor postre

Forchetta per antipasto e per dessert a base di frutta. Utilizzata per sbaglio spesso anche per i dessert a base dolce.  
Hors d'oeuvre fork used for fruit desserts, it is wrongly used for sweet desserts.



15

Forchettina Dolce  
Cake fork  
Fourchette à gateaux  
Kuchengabel  
Tenedor pastel

Forchetta per tutti i dolci e dessert, tranne quelli a base di frutta  
Fork used only for cakes and sweet desserts, but not for fruit.

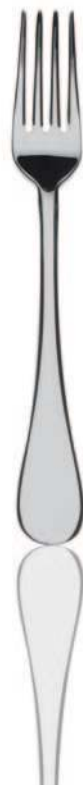

27

Forchettina Bebè  
Baby fork  
Fourchette pour enfant  
Kindergabel  
Tenedor bebè

Forchetta per bambini.  
Fork for babies courses.



21

Forchetta Pesce da tavola  
Table fish fork  
Fourchette poisson table  
Fischgabel  
Tenedor pescado

Forchetta per pesce e molluschi  
Fork for fishes and Mollusca



11

Forchettone a servire  
Serving fork  
Fourchette à legumes/ à servir  
Fleischgabel  
Tenedor legumbres

Si usa per servire sia primi piatti sia piatti principali.  
It's used to serve first and main courses



03

Coltello Tavola  
Table knife  
Couteau table  
Tafelmesser  
Cuchillo de mesa

Coltello per piatto principale. Può essere in manico cavo, come le vecchie consigli in tavola in argento, leggero ed esclusivo; oppure in manico pieno prodotto con la tecnologia della forgiatura.  
Table knife: Knife for main dishes with hollow handle, light and exclusive like the old fashioned silver covers or onepiece handle, made by the forging technology.



06

Coltello Frutta  
Dessert knife  
Couteau à dessert  
Dessertmesser  
Cuchillo postre

Coltello per antipasto e per dessert in combinazione con la forchetta frutta. Per qualità vale lo stesso discorso del coltello tavola  
Used with the fruit fork in the hors-d'oeuvre and the fruit desserts. It's quality is the same of the table knife.



20

Paletta Pesce da tavola  
Table fish knife  
Couteau poisson table  
Fischmesser  
Cuchillo pescado

Coltello per tagliare pesce e molluschi  
Knife used to slice fishes and Mollusca



28

Coltellino Bebè  
Baby knife  
Couteau pour enfant  
Kindermesser  
Cuchillo bebé

Coltellino per bambini.  
Knife for babies courses.



36

Coltello Bistecca  
Steak knife  
Couteau à viande  
Steakmesser  
Cuchillo bistek

Coltello con lama profonda per bistecche di spessore.  
Sharpedged blade knife helpful to cut substantial steaks



37

Coltello per burro  
Butter knife  
Couteau à beurre  
Buttermesser  
Cuchillo para mantequilla

Coltello per burro utilizzato per la prima colazione. Nella tradizione nordica ed inglese utilizzato sulla tavola in un piatto piano da frutta accanto al posto tavola, per spalmare il burro sul pane in occasione di lunch e dinner.  
Butter cover used during breakfast. In England and in the North European countries during lunch or dinner it is put in a dish near the table set to spread butter on the bread.



Must Have



**BRONZO**  
10001128B

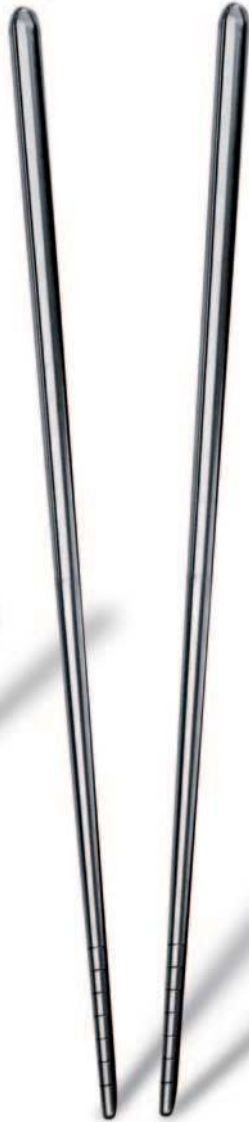

**ACCIAIO**  
10001128



**ORO NERO**  
10001128N

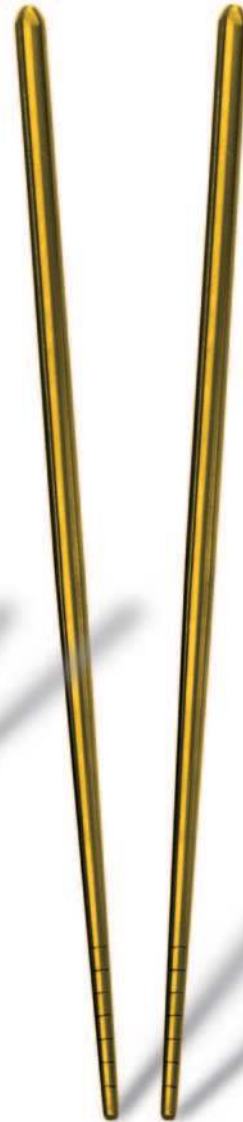

**ORO**  
10001128O

**ORO ICE**  
10001128OI



**906**  
Appoggia chopstick  
Chopstick rest  
Porte chopstick  
Ess-Stäbchen Ablage  
Apoyo para chopstick

Largh. cm. 4,5  
Width 1 3/4"

**1128**  
Paia Chopsticks  
Chopsticks set 2 pcs.  
Paire de chopsticks  
Ess-Stäbchen Paar  
Chopsticks 2 pzas.

cm. 22,5  
8 7/8"

## CHOP STICKS





**915**  
 Appoggia posate  
 Knife rest  
 Soutier p/couverts  
 Besteck Ablage  
 Apoyo p/cubiertos

Largh. cm. 6,5  
 Width 2 1/2"



**906**  
 Appoggia posate  
 Knife rest  
 Soutier p/couverts  
 Besteck Ablage  
 Apoyo p/cubiertos

Largh. cm. 4,5  
 Width 1 3/4"



**BRONZO**  
 10001175B



**ORO  
 NERO**  
 10001175ON



**ACCIAIO**  
 10001175



**ORO**  
 10001175O

**ORO ICE**  
 10001175OI

**1175**  
 Appoggia posate  
 Knife rest  
 Soutier p/couverts  
 Besteck Ablage  
 Apoyo p/cubiertos

Largh. cm. 6,5  
 Width 2 1/2"

## APPOGGIA POSATE





BRONZO  
10001144B



ACCIAIO  
10001144



ORO  
NERO  
10001144ON



ORO  
10001144O  
ORO ICE  
10001144OI

1144  
Coltello bistecca americano  
American steak knife  
Couteau entrecôte américain  
Amerikanisches Steakmesser  
Cuchillo bistek americano  
cm. 25  
9 5/8"

## BISTECCA AMERICANO





**UNI**  
10001136

Coltello bistecca  
Steak knife  
Couteau entrecôte  
Steakmesser  
Cuchillo bistek  
cm. 21,3  
8 1/4"

**NORMA**  
10101136  
**BOHEME**  
10231136

Coltello bistecca  
Steak knife  
Couteau entrecôte  
Steakmesser  
Cuchillo bistek  
cm. 23  
9 1/8"

**ROMA**  
10141136  
**1020B1136**  
**NATURA**  
10341136

Coltello bistecca  
Steak knife  
Couteau entrecôte  
Steakmesser  
Cuchillo bistek  
cm. 22,7  
8 7/8"

**10701136**  
**CARINZIA**

Coltello bistecca  
Steak knife  
Couteau entrecôte  
Steakmesser  
Cuchillo bistek  
cm. 23,1  
9 1/9"

**10711136**  
**STOCCOLMA**

Coltello bistecca  
Steak knife  
Couteau entrecôte  
Steakmesser  
Cuchillo bistek  
cm. 23,1  
9 1/9"

## BISTECCA





THE GOOD DESIGN AWARDS 2016

As Awarded by The Chicago Athenaeum:  
Museum of Architecture and Design



**JRE**  
JEUNES RESTAURATEURS



Ci sono Chef nel mondo che emozionano attraverso il gusto. Uno di questi è Ferran Adrià, cui omaggiamo l'idea della Quarta Posata, ispirata dalla sua pinza per tapas, oggi cambiata e migliorata per usi nuovi a tavola, insieme ai JRE Italia.

Cucchiaio, Forchetta, Coltello, Quarta Posata. Da oggi possiamo divertirci di più a tavola!

There are Chefs in the world who continuously create emotions through taste and do it better than us. One of these chefs is Ferran Adrià, who we honor with the idea of the Quarta Posata, inspired by his tapas tongs. Today, thanks to the collaboration with JRE Italy, is changed and improved for new uses on table: Spoon, Fork, Knife, Quarta Posata Starting today, we can have more fun on table!



## QUARTA POSATA





**10001129**  
Quarta posata

Lungh. cm. 22,2  
Length 8 3/4"





BRONZO  
10001139B



ACCIAIO  
10001139



ORO  
NERO  
10001139N



ORO  
10001139O  
ORO ICE  
10001139OI

1139  
Forchetta aragosta  
Lobster fork  
Curette à homard  
Hummergabel  
Tenedor langostas

cm. 19,4  
7 2/3"

## ARAGOSTA



NEW

NEW

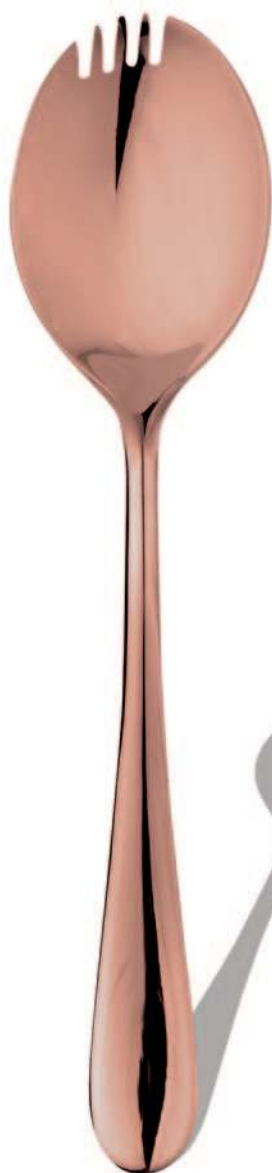

BRONZO  
10341146B



ACCIAIO  
10341146



ORO  
NERO  
10341146ON



ORO  
10341146O  
ORO ICE  
10341146OI

1146  
Cucchiaio multifunzione  
Multifunctional spoon  
Cuillère multifonctionnelle  
Multifunktionaler Löffel  
Cuchara multifuncional

cm. 17,6  
6 5/8"

## MULTIFUNZIONE



NEW

NEW



BRONZO  
10101130B



ACCIAIO  
10101130



ORO  
NERO  
10101130ON



ORO  
10101130O

ORO ICE  
10101130OI

1130  
Amuse-bouche spoon

cm. 14,5  
5 3/4"

## AMUSE-BOUCHE



NEW

NEW



BRONZO  
10001133B



ACCIAIO  
10001133



ORO  
NERO  
10001133ON



ORO  
10001133O  
ORO ICE  
10001133OI

1133  
Cucchiaio per miele  
Honey spoon  
Cuillère à miel  
Honiglöffel  
Cuchara de miel

cm. 16  
6 1/4"

MIELE





BRONZO  
200727B



ORO  
NERO  
200727ON



ACCIAIO  
200727



ORO  
200727O

ORO ICE  
200727OI

727  
Coppa per intermezzo  
Intermezzo cup  
Coupe à intermezzo  
Sorbetschale  
Copa para intermezzo

cl. 4  
oz. 1 <sup>3</sup>/<sub>8</sub>

## INTERMEZZO



NEW

421

FASHION  
Appoggia posate  
Knife rest  
Soutier p/couverts  
Besteck Ablage  
Apoyo p/cubiertos

cm. 12 x 8  
4 3/4" x 3 1/7"

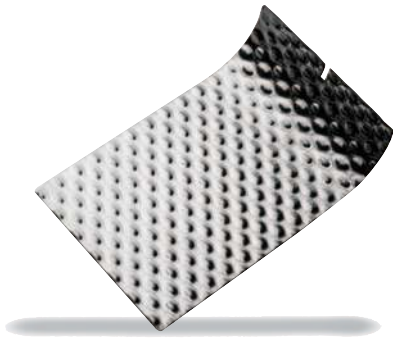

NEW

423

FASHION  
Appoggia posate  
Knife rest  
Soutier p/couverts  
Besteck Ablage  
Apoyo p/cubiertos

cm. 11 x 3  
4 1/3" x 1 1/5"



920

Appoggia posate  
Knife rest  
Soutier p/couverts  
Besteck Ablage  
Apoyo p/cubiertos

cm. 10 x 8  
4" x 3 1/7"



NEW

424

GIOTTO  
Appoggia posate  
Knife rest  
Soutier p/couverts  
Besteck Ablage  
Apoyo p/cubiertos

cm. 11 x 3  
4 1/3" x 1 1/5"



740

Coppetta amouse bouche  
Appetizer bowl  
Bol multi-usages  
Fingerfood-/Vorspeisen-/Butter-Gefäss  
Cuenco para finger food/amouse bouche

cm. 13 x 7 - cl. 4  
5 1/9" x 2 3/4" - oz. 4



10521131

Mini Forchetta  
Appetizer fork  
Fourchette amouse bouche  
Minigabel  
Mini tenedor

cm. 11,4  
4 1/2"



10521108  
Mini spoon

cm. 11,4  
4 1/2"



750

Micro forchetta  
Micro fork  
Micro fourchette  
Mikrogabel  
Micro tenedor





**ARAGOSTE**



**10001140**  
Pinza aragosta  
Lobster pincers  
Pince à homard  
Hummerzange  
Pinzalangostas  
cm. 18,5  
7 1/3"



**10001139**  
Forchetta aragosta  
Lobster fork  
Fourchette langouste  
Hummergabel  
Tenedor langostas  
cm. 19,4  
7 2/3"



**1020B1143**  
Cucchiaio risotto  
"Risotto" spoon  
Cuillère "Risotto"  
Reislöffel  
Cuchara arroz seco  
cm. 27,7  
11"



**10201144**  
Cucchiaino cappuccino  
Cappuccino spoon  
Cuillère cappuccino  
Cappucinolöffel  
Cucharita cappuccino  
cm. 16,5  
6 1/2"



**10001150**  
Golf club mixer spoon  
Golf club mixer spoon  
Golf crosse pour cocktail  
Golf Schlegler für Long drink  
Golf club cucharita por coctél  
cm. 16,5  
6 1/2"

Modelli-Models  
**POSATE**

**LUMACHE**



**779**  
Molla lumache  
Escargot tongs  
Pince escargots  
Schneckenzange  
Pinzas caracoles  
cm. 15,6  
6 1/4"



**10001138**  
Forchetta lumache  
Escargot fork  
Fourchette escargots  
Schnecken-gabel  
Tenedor caracoles  
cm. 14,9  
5 7/8"

**FORMAGGIO**



**10001147**  
Forchetta formaggio  
Cheese fork  
Fourchette fromage  
Käsegabel  
Tenedor queso  
cm. 21  
8 3/8"



**10001125**  
Coltello formaggio  
Cheese knife  
Couteau fromage  
Kaesemesser  
Cuchillo queso  
cm. 22  
8 3/4"



**10001126**  
Coltello parmigiano  
Parmesan chesse knife  
Couteau parmesan  
Parmesanmesser  
Cuchillo parmigiano  
cm. 16,5  
6 1/2"



10001109



cm. 22  
8 5/8"

mm. 3,0

Mestolo  
Ladle  
Louche  
Suppschöpfer  
Cazo sopa

mm. 3,0



cm. 18,5  
7 1/4"

10001116

Pala per torta  
Cake trowel  
Pelle à tarte  
Tortenheber  
Pala tarta

10001142



cm. 20,7  
8 1/8"

mm. 3,0

Cucchiaione  
da risotto  
Spoon for "Risotto"  
Cuillère à "Risotti"  
Reislöffel  
Cuchara para arroz seco

mm. 2,5



cm. 10,5  
4 1/4"

10001115

Forchettina dolce  
Cake fork  
Fourchette à gateaux  
Kuchengabel  
Tenedor pastel

10001110



cm. 17,5  
6 3/4"

mm. 3,0

Cucchiaione  
Serving spoon  
Cuillère à servir  
Servierlöffel  
Cuchara servir

mm. 3,0



cm. 15,5  
6"

10001120

Paletta pesce tavola  
Table fish knife  
Couteau poisson  
Fischmesser  
Pala pescado

10001111



cm. 17  
6 5/8"

mm. 3,0

Forchettone  
Serving fork  
Fourchette à servir  
Serviergabel  
Tenedor servir

mm. 3,0



cm. 15,5  
6"

10001121

Forchetta pesce tavola  
Table fish fork  
Fourchette poisson  
Fischgabel  
Tenedor pescado

10001122



cm. 17  
6 5/8"

mm. 3,0

Cucchiaio insalata  
Salad serving spoon  
Cuillère à salade  
Salatvorlegelöffel  
Cuchara para ensalada

mm. 3,0



cm. 12,5  
4 7/8"

10001141

Happy spoon

10001123



cm. 17  
6 5/8"

mm. 3,0

Forchetta insalata  
Salad serving fork  
Fourchette à salade  
Salatvorlegegabel  
Tenedor para ensalada

mm. 2,5



cm. 8,5  
3 3/8"

10001124

Paletta gelato  
Ice-cream spoon  
Cuillère à glâce  
Eislöffel  
Cucharita helado

HAPPY



# Fantasia



● Non ci si stanca mai del colore, soprattutto in ciò che ci circonda. Fantasia è un apostrofo funky tra le parole "Eleganza" e "Raffinatezza" di tutte le nostre collezioni. le posate sono realizzate in acciaio inossidabile 18/10 e da coloratissimi manici ad alta resistenza (hanno la stessa resistenza del legno, ma si possono lavare in lavastoviglie migliaia di volte).

● You never get tired of the color, especially in our surroundings. Fantasy is a funky apostrophe between the words "Elegance" and "Refinement" of all our collections. the cutlery are made of 18/10 stainless steel and highly coloured handles with high resistance (it has the same resistance of the wood, but it can be washed in the dishwasher thousands of times).

Fantasia è:

- Ultraresistente
- Lavabile in lavastoviglie
- Saldata ad ultrasuoni per una tenuta perfetta
- Acciaio inossidabile 18/10 ad elevato spessore
- Garantita a vita
- Ideale per:
- Pool & Pathio
- Spiaggie
- Urban & Pop
- Ospedali
- Case di residenza per anziani
- Yacht
- Chalet
- Giardini
- Loft

Fantasia is:

- Ultra-resistant
- Dishwasher safe
- Ultrasonic welded for a perfect seal
- High thickness 18/10 Stainless steel
- Lifetime guaranteed
- Ideale for:
- Pool & Pathio
- Beaches
- Urban & Pop
- Hospitals
- Retirement homes
- Yacht
- Chalet
- Rooftop Gardens
- Loft





Mirror



**O**

**ON**

**B**

**C**

**A**

**AR**

Oro  
Lucido

Oro Nero  
Lucido

Bronzo  
Lucido

Champagne  
Lucido

Arcobaleno  
Lucido

Argentato  
Lucido



Ice



**OI**

**ION**

**IB**

**IC**

**IA**

**ARI**

Oro  
Ice

Oro Nero  
Ice

Bronzo  
Ice

Champagne  
Ice

Arcobaleno  
Ice

Argentato  
Ice



Peltro



**PO**

Oro  
Peltro

**PON**

Oro Nero  
Peltro

**PB**

Bronzo  
Peltro

**PC**

Champagne  
Peltro

**PA**

Arcobaleno  
Peltro

**PAR**

Argentato  
Peltro

# COLORI DISPONIBILI



**N**  
Nero  
Black



**I**  
Vigogna  
Vicuna



**W**  
Porcellana  
China



**M**  
Tabacco  
Tobacco



**S**  
Salvia  
Sage



**T**  
Tortora  
Turte-dove



**L**  
Vaniglia  
Vanilla



**D**  
Sesamo  
Sesame



**B7**  
Ciclamino  
Light mauve



**H7**  
Lilla  
Lilac



**P7**  
Rosa  
Pink



**Z7**  
Rosa pallido  
Pale Rose



**V**  
Verde  
Green



**A7**  
Mela verde  
Apple Green



**E**  
Verde acido  
Acid Green



**Q7**  
Verde oliva  
Olive Green

# AVAILABLE COLORS



# PEZZI DISPONIBILI

## 10(color)1101

Cucchiaio tavola  
Table spoon



Lunghezza 197 mm  
Length 7 3/4"

## 10(color)1102

Forchetta tavola  
Table fork



Lunghezza 197 mm  
Length 7 3/4"

## 10(color)1103

Coltello tavola  
Table knife



Lunghezza 223 mm  
Length 8 3/4"

## 10(color)1104

Cucchiaio frutta  
Dessert spoon



Lunghezza 174 mm  
Length 6 7/8"

## 10(color)1105

Forchetta frutta  
Dessert fork



Lunghezza 175 mm  
Length 6 8/9"

## 10(color)1106

Coltello frutta  
Dessert knife



Lunghezza 197 mm  
Length 7 3/4"

## 10(color)1107

Cucchiaino caffè  
Tea spoon



Lunghezza 133 mm  
Length 5 1/4"

## 10(color)1115

Forchettina dolce  
Cake fork



Lunghezza 157 mm  
Length 6 1/5"

## 10(color)1126

Cucchiaino caffè americano  
American size coffee spoon



Lunghezza 156 mm  
Length 6 1/7"

## 10(color)1116

Pala per torta  
Cake trowel



Lunghezza 254 mm  
Length 10"

# AVAILABLE RANGE

## 10(color)1122

Cucchiaio insalata a servire  
Salad serving spoon



Lunghezza 233 mm  
Length 9 1/6"

## 10(color)1123

Forchetta insalata a servire  
Salad serving fork



Lunghezza 233 mm  
Length 9 1/6"

## 10(color)1110

Cucchiaione  
Serving spoon



Lunghezza 235 mm  
Length 9 1/4"

## 10(color)1111

Forchettone  
Carving fork



Lunghezza 235 mm  
Length 9 1/4"

## 10(color)1140

Mestolino per salsiera  
Gravy ladle



Lunghezza 185 mm  
Length 7 1/4"

## 10(color)1120

Paletta pesce da tavola  
Table fish knife



Lunghezza 198 mm  
Length 7 4/5"

## 10(color)1121

Forchetta pesce da tavola  
Table fish fork



Lunghezza 195 mm  
Length 7 2/3"

## 10(color)1143

Cucchiaone da risotto  
Rice spoon



Lunghezza 277 mm  
Length 10 8/9"

## 10(color)1142

Forchetta per fonduta  
Fondue fork



Lunghezza 290 mm  
Length 11 2/5"

# Vasellame



HOLLOWARE  
MATERIEL DE SERVICE  
ACCESSOIRES  
ORFEBRERIA

- Gamma completa per tutti gli usi
- Spessore elevato
- Doppia saldatura manici, alta resistenza
- Beccucci rompigoccia
- Prodotti impilabili salvaspazio
- Criterio di progettazione di ogni prodotto accuratamente studiato per il quotidiano uso nel settore alberghiero.
- Each collection offers an extensive range of different items.
- Thicker stainless steel.
- Double welded handles offer durability.
- Drip-less spouts on all pitchers, creamers, coffee and tea pots.
- Space saving stackable items.
- Hospitality grade and professional quality

**MEPRA**  
S.p.A.

- Gamme complète pour tous les us
- Épaisseur massives
- Soudures manches haute résistance
- Becs rompigoutes
- Articles empilables pour sauver space
- Critère de projet de chaque produit est étudié pour l'usage quotidien soigneusement dans le secteur hôtelier

- Ein vollständiges Sortiment für jeden Gebrauch
- Hohe Materialstärke
- Doppelt geschweisste
- Handgriffe, hohe Widerstandsfähigkeit
- Kein Tropfen beim Ausgießen
- Stapelbar und platzsparend
- Jedes Produkt ist genaustens für den täglichen Gebrauch in der Spitzengastronomie und -hotellerie gestaltet

- Gamma completa para todos los usos.
- Espesor macizo
- Mango soldado de alta resistencia.
- Vertedor rompe gotas
- Producto apilable ahorra espacio
- Criterio de diseño de cada producto estudiado minuciosamente para el uso cotidiano en el sector hostelero.

**MEPRA**  
S.p.A.





# Carbon Fiber



14270

ANNIE

Vassoio in carbonio

Carbon fiber tray

Plateau en fibre de carbone

Kohlefaser-Tablett

Bandeja de fibra de carbono

cm. 72 x 50

28 1/3" x 19 3/4"





# Atmosfera

# ATMOSFERA

La collezione ATMOSFERA è realizzata in acciaio inossidabile 18/10 con un trattamento di verniciatura in polvere. Oltre alla collezione ATMOSFERA, possiamo realizzare tutto il vasellame di questo catalogo nei tre colori:

The ATMOSFERA collection is made of 18/10 stainless steel with a powder coating treatment. In addition to the collection ATMOSFERA, we can make all the tableware of this catalog in the three colors:

La collection ATMOSFERA est réalisée en acier inoxydable 18/10 avec un traitement de revêtement en poudre. En plus de la collection ATMOSFERA, nous pouvons faire toute la vaisselle de ce catalogue dans les trois couleurs:

Die ATMOSFERA Kollektion besteht aus 18/10 Rostfrei von pulverförmig. Zusätzlich der Kollektion ATMOSFERA, können wir dieses Katalog in den drei Farben machen:

La colección ATMOSFERA está hecha de acero inoxidable 18/10 con un tratamiento de recubrimiento en polvo. Además de la colección ATMOSFERA, podemos realizar toda la orfebrería de este catálogo en los tres colores:



**O**  
Materic Gold



**N**  
Vulcan Grey



**B**  
Materic Bronze

1016



mm. 1,2

MERCURIO  
Cestino  
Basket  
Corbeille  
Früchtekorb  
Cesta

Ø cm. 11    Ø 4 3/8"  
H cm. 12,5    H 4 7/8"  
cl. 55        oz. 18 5/8

1017



mm. 1,2

Ø cm. 19  
H cm. 20  
Lt. 2,5

Ø cm. 29    Ø 7 1/2"  
H cm. 18,5    H 7 3/4"  
Lt. 8        oz. 84 1/2

669MG



mm. 1,2

Cestino  
Basket  
Corbeille  
Früchtekorb  
Cesta

Ø cm 14  
H cm 13,5  
lt. 0,70

Ø 5 2/3"  
H 5 1/8"  
oz. 23 2/3

668MG



mm. 1,2

Secchiello per spumante  
Sparkling wine cooler  
Seau à champagne  
Wein- und Sektkühler  
Cubo para champany

Ø cm 24  
H cm 23  
lt. 2,75

Ø 9 1/2"  
H 9"  
oz. 93

666FMG



mm. 1,2

Colonna portasecchiello  
Wine cooler stand  
Pied pour seau à champagne  
Weinkühlerständer  
Columna porta cubo champany

H cm. 65 H 25 5/8"



1011



1014



1013



1012



mm. 1,2

GIOVE  
Cestino  
Basket  
Corbeille  
Früchtekorb  
Cesta

**1011**

cm. 16,6 x 10  
H cm. 14,2  
cl. 180  
6 1/2" X 4"  
H 5 3/5"  
oz. 60 7/8

**1014**

cm. 27 x 20,5  
H cm. 21,5  
Lt. 6,5  
10 5/8" X 8"  
H 8 1/2"  
gal. 1 3/4

mm. 1,2

MARTE  
Cestino  
Basket  
Corbeille  
Früchtekorb  
Cesta

**1013**

Ø cm. 29  
H cm. 18,5  
Lt. 8  
Ø 11 3/8"  
H 7 1/4"  
gal. 2

**1012**

Ø cm. 16,8  
H cm. 11  
cl. 150  
Ø 6 5/8"  
H 4 3/8"  
oz. 50 3/4

666HMG



666CMG



mm. 1,2

Colonna portasecchiello spumante  
Wine cooler stand  
Pied pour seau à champagne  
Weinkühlerständer  
Columna porta cubo champany

H cm. 61,5

H 24 1/5"

mm. 1,2

Colonna portasecchiello spumante  
Wine cooler stand  
Pied pour seau à champagne  
Weinkühlerständer  
Columna porta cubo champany

H cm. 67,5

H 26 5/8"

1009



mm. 1,2

VENERE  
Cestino  
Basket  
Corbeille  
Früchtekorb  
Cesta

cm. 22 x 20  
H cm. 11,5  
Lt. 1,2

8 5/8" x 7 7/8"  
H 4 5/8"  
oz. 40 1/2

1010



mm. 1,2

VENERE  
Cestino  
Basket  
Corbeille  
Früchtekorb  
Cesta

cm. 39 x 36  
H cm. 17,5  
Lt. 7

15 3/8" x 14 1/4"  
H 7"  
gal. 1 4/5

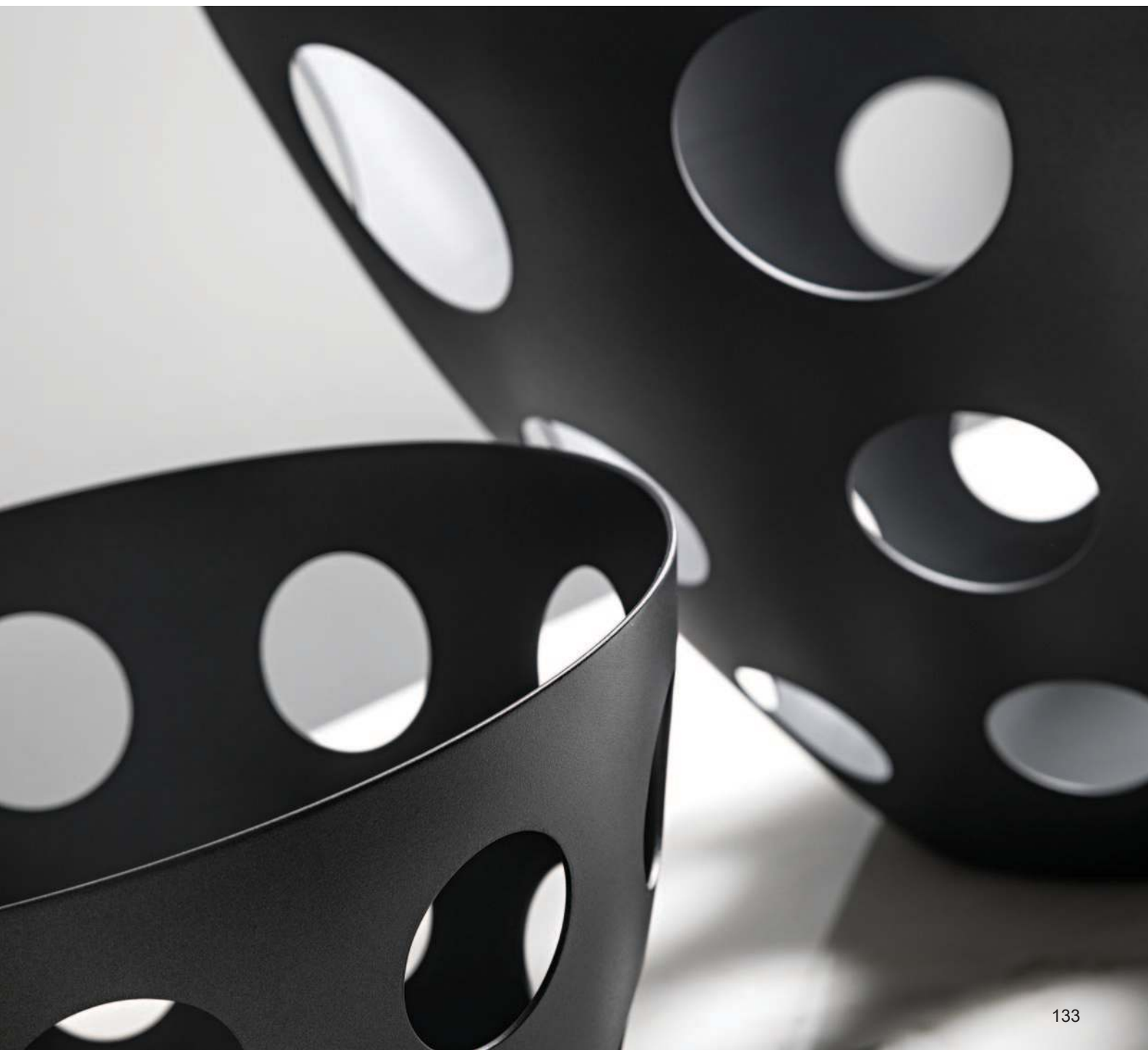

1001



mm. 1,2 SATURNO  
Piano  
Tray  
Plateau  
Tablett oval  
Bandeja

cm. 40 x 36 15 3/4" x 14 1/8"

1006



mm. 1,2 SATURNO  
Piano  
Tray  
Plateau  
Tablett oval  
Bandeja

cm. 22 x 20 8 5/8" x 7 7/8"

1003



mm. 1,2 SATURNO  
Piano  
Tray  
Plateau  
Tablett oval  
Bandeja

cm. 34 x 31 13 3/8" x 12 1/4"

1004



mm. 1,2 SATURNO  
Piano  
Tray  
Plateau  
Tablett oval  
Bandeja

cm. 14 x 12 5 1/2" x 4 3/4"

1002



mm. 1,2 NETTUNO  
Cestino  
Basket  
Corbeille  
Früchtekorb  
Cesta

**100222**  
cm. 22 x 20  
cl. 100

**100240**  
cm. 40 x 36  
cl. 200

**100222**  
8 5/8" x 7 7/8"  
OZ. 33 7/8

**100240**  
15 3/4" x 14 1/8"  
OZ. 67 5/8

1005



mm. 1,2 PLUTONE  
Allacciatovaglioli  
Napkins ring  
Rond de serviette  
Serviettenring  
Servilletero

Ø cm. 6 Ø 2 3/8"



# Sushic



787



787

TRE  
Vassoio per prima colazione  
Breakfast tray  
Plateau rect. pour le petit déjeuner  
Frühstück Tablett, rechteckig  
Bandeja rect. por desayuno

cm. 50 x 32 27 1/2" x 12 5/8"

791AC



NEW

155



NEW

163



Inserto Finger Food per vassoio quadro e rettangolare  
Finger Food insert for square and rectangular tray  
Insért Finger Food pour plateau carré et rectangulaire  
Finger Food-Einsatz für quadratische/rechteckig Schale  
Inserto para Finger Food por bandeja cuadrada y rectangular  
mm. 1,2

cm. 30 x 30

11 7/8" x 11 7/8"

Porta noccioli  
Olive seeds jar  
Porte noyaux  
Aderhalter  
Porta granos  
mm. 1,2

Ø cm. 6  
H cm. 5  
cl. 5

Ø 2 2/5"  
H 2"  
oz. 1 3/4

TRE  
Set per aperitivi  
Appetizer set  
Set pour Amouse bouche  
Vorspeisen Set  
Set para aperitivos

cm. 22 x 22  
cl. 30

8 5/8" x 8 5/8"  
oz. 10 1/8

793



TRE  
Completo oliera con spargisale  
Cruet and salt cellar set  
Huile-vinaigre 4 pcs  
Essig-/Öl-Menage 4-Tlg.  
Vinagreras con saleros

cm. 15 x 15 6" x 6"  
H cm. 19,6 H 7 3/4"  
cl. 30 (x2) oz. 10 1/8 (x2)  
cl. 8 (x2) oz. 2 3/4 (x2)

794



TRE  
Formaggera  
Parmesan cheese basin  
Fromagère  
Käsedose  
Quesera Azucarero

cm. 15 x 15 6" x 6"  
cl. 20 oz. 6 3/4

792



TRE  
Vassoio rettangolare  
Rectangular tray  
Plateau rectangulaire  
Tablett, rechteckig  
Bandeja rectangular

cm. 50 x 32 19 3/4" X 12 3/4"  
cm. 30 x 20 11 3/4" X 7 7/8"

788



QUATTRO  
Vassoio rettangolare  
Rectangular tray  
Plateau rectangulaire  
Tablett, rechteckig  
Bandeja rectangular

cm. 50 x 32 19 3/4" X 12 3/4"  
cm. 30 x 20 11 3/4" X 7 7/8"

791



TRE  
Vassoio/Sottopiatto  
Square Tray/Charger  
Plateau/Assiette de bienvenue  
Tablett/Platzteller,  
Bandeja/Bajo plato

cm. 32 x 32 12 3/4" x 12 3/4"

789



QUATTRO  
Vassoio/Sottopiatto  
Square Tray/Charger  
Plateau/Assiette de bienvenue  
Tablett/Platzteller,  
Bandeja/Bajo plato

cm. 32 x 32 12 3/4" x 12 3/4"

795



TRE  
Tovaglietta americana  
Place mat  
Set de table  
americain en bois  
Tischset aus Holz  
individual en madera

cm. 38 x 28 15" x 11"

796



TRE  
Sottopiatto  
Charger  
Assiette de bienvenue  
Platzteller  
Bajo plato

Ø cm. 33 Ø 13"

804



TRE  
Portacondimenti  
Basket for aromatic condiments  
Corbeille pour aromatiques condiments  
Tisch-Essig/Öl-Flaschenhalter  
Cesto para aromaticos y condimentos

cm. 15 x 15 6" x 6"  
H cm. 19,6 H 7 3/4"

797



TRE  
Cestino quadrato  
Square basket  
Corbeille carré  
Schale, eckig  
Panera cuadrada

cm. 15 x 15 6" x 6"  
cm. 20 x 20 7 7/8" x 7 7/8"

599

58928

7 colori disponibili - pag. 312 - 313  
7 colors available - pages 312 - 313  
7 couleurs disponibles - pag. 312 - 313  
7 verschiedenen Farben verfügbar - Seiten 312 - 313  
7 colores disponibles - pag. 312 - 313

589 - Ø cm. 28  
Ø 11"



mm. 1,2

UNO  
Cestino traforato  
Fretworked basket  
Corbeille, ajourée  
Früchtekorb gelocht  
Cesta perforada

Ø cm. 29 Ø 11 3/8"  
H cm. 18,5 H 7 1/4"  
lt. 8 gal. 2

666B

Disponibile in color  
Available in walnut  
Disponible en couleur  
In Wengè und Walnuss  
Disponible en color

noce e wengè  
and wengè color  
noyer et wengè  
Farbe verfügbar  
nuez y wengè



TRE  
Colonna portasecchiello  
Wine cooler stand  
Pied pour seau à champagne  
Weinkühlerständer  
Columna porta cubo champany

H cm. 65 H 25 5/8"



**A** Noce  
Walnut  
Noyer  
Walnuss  
Nuez

**R** Rovere  
Oak  
Chêne  
Eiche  
Roble

**W** Wengé





3504

3404

S7



S7



BARCELONA

J



J



Ø cm. 12,5

Ø 5"

cm. 14 x 14

5 1/2" x 5 1/2"

3503

3403

F7



F7



AMSTERDAM

N7



N7



Ø cm. 12,5

Ø 5"

cm. 14 x 14

5 1/2" x 5 1/2"

3505

3405

H7



H7



BERLIN

Q7



Q7

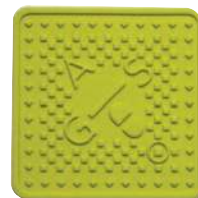

Ø cm. 12,5

Ø 5"

cm. 14 x 14

5 1/2" x 5 1/2"



3200

S7



3100  
3600

S7



ROMA

S7

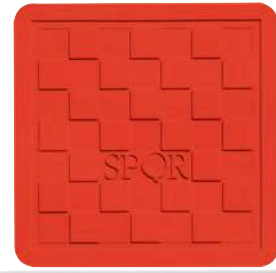

3300

J

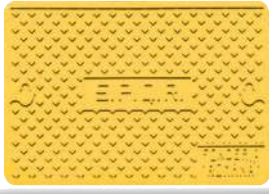

cm. 30 x 45

11 3/4" x 17 3/4"

3100  
3600

J



3100  
3600

Ø cm. 17    Ø 6 3/4"  
Ø cm. 35    Ø 13 7/8"

J



cm. 45 x 45

17 3/4" x 17 3/4"

3202

F7



3102  
3602

F7



LONDON

F7



3302

H7



cm. 30 x 45

11 3/4" x 17 3/4"

3101  
3601

H7



PARIS

H7



3301

Q7



cm. 30 x 45

11 3/4" x 17 3/4"

3101  
3601

Q7



3101  
3601

Ø cm. 17    Ø 6 3/4"  
Ø cm. 35    Ø 13 7/8"

Q7



cm. 45 x 45

17 3/4" x 17 3/4"



845



mm. 1,2	Portaghiaccio termico con coperchio	H cm 13	H 5"
	Insulated ice-bucket with lid	Ø cm 14	Ø 5 1/2"
	Seau à glaçons thermique avec couvercle	cl.72	oz. 24 1/3
	Thermo Eiseimer mit Deckel	H cm 22	H 8 5/8"
Cubitera hielo con tapa		Ø cm 24	Ø 9 1/2"
		lt. 4,0	gal. 1

843



856

mm. 1,2	Secchiello per spumante	H cm 13	H 5"
	Sparkling wine cooler	Ø cm 14	Ø 5 1/2"
	Seau à champagne	cl.125	oz. 42 1/4
	Wein- und Sektkühler	H cm 22	H 8 5/8"
Cubo para champany		Ø cm 24	Ø 9 1/2"
		lt. 4,0	gal. 1

666G

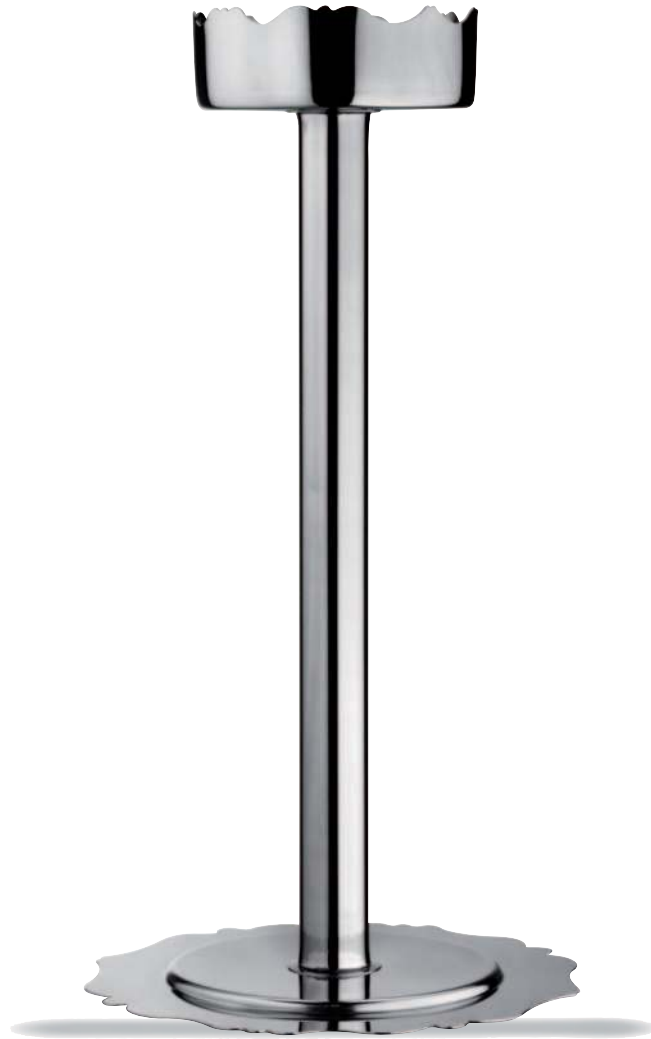

mm. 1,2	Colonna portasecchiello spumante	H cm. 62	H 24 3/8"
	Wine cooler stand		
	Pied pour seau à champagne		
	Weinkühlerständer		
Columna porta cubo champany			

800



mm. 1,2 Vassoio rettangolare c/interno ovale  
 Rectangular tray, w/oval int.part  
 Plateau rectangulaire a/partie interne ovale  
 Tablett rechteckig mit ovaler Innenform  
 Bandeja rectangular con la parte interna ovalada

cm. 47x34 18<sup>1</sup>/<sub>2</sub>" x 13<sup>3</sup>/<sub>8</sub>"  
 cm. 56x40 22" x 15<sup>3</sup>/<sub>4</sub>"

808



mm. 1,2 Vassoio quadro con interno tondo  
 Square tray, w/round internal part  
 Plateau carré a/partie interne ronde  
 Tablett quadratisch mit runder Innenform  
 Bandeja cuadrada c/la parte interna redonda

cm. 40x40 15<sup>3</sup>/<sub>4</sub>" x 15<sup>3</sup>/<sub>4</sub>"

801



mm. 1,2 Vassoio rettangolare c/int.ovale c/piedini  
 Rect.tray, w/oval int.part and feet  
 Plateau rect.a/partie ovale int. sur pied  
 Tablett rechteckig mit ovaler Innenform und Füßen  
 Bandeja rect.c/parte int.oval.y pies

cm. 47x34 18<sup>1</sup>/<sub>2</sub>" x 13<sup>3</sup>/<sub>8</sub>"  
 cm. 56x40 22" x 15<sup>3</sup>/<sub>4</sub>"

809



mm. 1,2 Vassoio quadro c/int.tondo c/piedini  
 Square tray, w/round int.part w/feet  
 Plat.carré a/partie int.ronde s/pied.  
 Tablett quadratisch mit runder Innenform und Füßen  
 Band.cuad.c/parte int.red.y 3 pies

cm. 40x40 15<sup>3</sup>/<sub>4</sub>" x 15<sup>3</sup>/<sub>4</sub>"

802



mm. 1,2 Vassoio rett.c/int.ovale e pied.  
 Rect.tray, w/oval int.part w/base  
 Plateau rect.a/par.int. ovale s/socle  
 Tablett rechteckig mit ovaler Innenform und Fuss  
 Bandeja rect.c/parte int.oval. y pedestal

H cm. 14 H 5 1/2"  
 cm. 47x34 18<sup>1</sup>/<sub>2</sub>" x 13<sup>3</sup>/<sub>8</sub>"  
 cm. 56x40 22" x 15<sup>3</sup>/<sub>4</sub>"

807



mm. 1,2 Vassoio quadro c/int.tondo c/pied.  
 Square tray, w/round int.part w/base  
 Plat.carré a/partie int.ronde e/socle  
 Tablett quadratisch mit runder Innenform und Fuss  
 Band.cuad.c/parte int.red.y pedest.

H cm. 18 H 7"  
 cm. 40x40 15 3/4" x 15 3/4"

805



mm. 1,2 Vassoio rettangolare  
Rectangular Tray  
Plateau rectangulaire  
Tablett rechteckig  
Bandeja rectangular  
cm. 48 x 36 18<sup>7</sup>/<sub>8</sub>" x 14<sup>1</sup>/<sub>8</sub>"

861



mm. 1,2 Vassoio portalettere/portaconto  
Tray for correspondence, for bill  
Plateau à main  
Tablett für Korrespondenz oder  
Rechnungen  
Bandeja para la correspondencia o  
facturas  
cm. 26 x 22 10" x 8 1/2"

806



mm. 1,2 Vassoio rett.c/int.rett.con piedini  
Rect.tray, w/rect.int.part and feet  
Plateau rect.a/partie int.rect.s/pied  
Tablett rechteckig mit Füßen  
Bandeja rect.c/parte int.rect.c/4 pies  
cm. 26x22 10" x 8 1/2"  
cm. 48x36 18<sup>7</sup>/<sub>8</sub>" x 14<sup>1</sup>/<sub>8</sub>"

862



mm. 1,2 Vassoio portalettere, portaconto  
con piedini  
Tray for correspondence, for bill w/feet  
Plateau à main sur pieds  
Tablett für Korrespondenz oder  
Rechnungen mit Füßen  
Bandeja para la correspondencia  
o facturas con 4 pies  
cm. 26 x 22 10" x 8 1/2"

810



mm. 1,2 Vassoio rett.c/int.rett.con piedist.  
Rect.tray, w/rect.int.part and base  
Plateau rect.a/partie int.rect.s/socle  
Tablett rechteckig mit Fuss  
Bandeja rect.c/parte int.rect.c/ped.  
H cm. 14 H 5 1/2"  
cm. 26x22 10 x 8 1/2"  
cm. 48x36 18<sup>7</sup>/<sub>8</sub>" x 14 1/4"

863



mm. 1,2 Vassoio portalettere, portaconto con piedistallo  
Tray for correspondence, for bill w/feet  
Plateau pour la correspondance ou factures  
sur socle  
Tablett für Korrespondenz oder Rechnungen m/Fuss  
Bandeja para la correspondencia o facturas c/ped.  
H 13,5 H 5 3/8"  
26 x 22 10" x 8 1/2"

860



mm. 1,2 Cestino rotondo  
Round bowl  
Bol rond/Corbeille  
Schale, rund  
Cuenco redondo

Ø cm. 18    Ø 7 1/8"

858



mm. 1,2 Ciotola finger food/amouse/bouche/burro  
Finger food/amouse bouche/butter bowl  
Bol multi-usages  
Fingerfood-/Vorspeisen-/Butter-Gefäss  
Cuenco para finger food/amouse  
bouche/mantequilla

Ø cm. 8,5    Ø 3 3/8"

826



mm. 1,2 Cestino  
Basket  
Corbeille  
Schale  
Cuenco

cm. 13 x 13    5 1/8" x 5 1/8"  
cm. 16 x 16    6 3/8" x 6 3/8"  
cm. 32 x 32    12 5/8" x 12 5/8"

828



mm. 1,2 Centrotavola  
Centerpiece  
Centre de table  
Tafelaufsatz  
Centro de mesa

H cm. 7    H 2 7/8"  
cm. 27 x 27    10 5/8" x 10 5/8"  
cm. 37 x 37    14 5/8" x 14 5/8"

827



mm. 1,2 Cestino con piedistallo  
Basket with base  
Corbeille sur socle  
Obstkorb auf Fuss  
Cesta con pedestal

H cm. 19,5    H 7 5/8"  
cm. 13 x 13    5 1/8" x 5 1/8"

H cm. 23    H 9"  
cm. 16 x 16    6 3/8" x 6 3/8"

H cm. 26,5    H 10 1/2"  
cm. 32 x 32    12 5/8" x 12 5/8"



840



mm. 1,2 | Portabustine/biglietti da visita  
Sugar packet/business card holder  
Porte cartes/sachets  
Zuckerbeutel- Visitenkartenhalter  
Azucarera/Porta tarjetas comerciales

cm. 10 x 7 4 1/8" x 2 7/8"

830



mm. 1,2 | Svuoatasche  
Square basket  
Corbeille carrée  
Schale, eckig  
Cuenco cuadrado

cm. 15 x 15 5 7/8" x 5 7/8"  
cm. 22 x 22 8 5/8" x 8 5/8"

848



mm. 1,2 | Porta pasticcini  
Petit-fours stand  
Porte-petits fours  
Kuchen/Gebäckplatte auf Fuß  
Porta dulces

H cm. 9,5 H 3 3/4"  
Ø cm. 14 Ø 5 1/2"

H cm. 14 H 5 1/2"  
Ø cm. 21 Ø 8 1/4"

826



842



mm. 1,2 | Porta pasticcini a 2 piani  
Petit-fours stand 2 layers  
Porte-petit fours 2 étages  
Kuchen/Gebäckplatte 2-stufig  
Porta dulces 2 pisos

H cm 25,5 H 10"  
Ø cm 14-21 Ø 5 1/8" - 8 1/4"



mm. 1,2 | Alzata portafrutta rettangolare 2p.  
Rectangular fruit holder 2 layers  
Serveur rectangulaire 2 étages  
Etagere, rechteckig 2-stufig  
Frutero rectangular 2 pisos

H cm. 44 H 17 3/8"  
cm. 47 x 34 18 1/2" x 13 3/8"  
cm. 56 x 40 22" x 15 3/4"

813



mm. 1,2 Sottopiatto quadro  
Square charger  
Assiette de bienvenue carrée  
Platzteller, viereckig  
Bajo plato cuadrado

cm. 32 x 32 12 5/8" x 12 5/8"



838



mm. 1,2 Sottobicchiere  
Glass coaster  
Dessous de verre  
Glasuntersatz  
Posavasos

cm. 10 x 10 4" x 4"

839



mm. 1,2 Sottobottiglia  
Bottle coaster  
Dessous de bouteille  
Flaschenuntersatz  
Posabotella

cm. 14 x 14 5 1/2" x 5 1/2"

833



mm. 1,0 Portatovaglioli  
Napkin holder  
Distributeur de serviettes  
Serviettenhalter  
Portaservilletas

H cm. 9 H 3 1/2"  
cm. 12,5 x 4 5" x 1 5/8"

846



mm. 1,0 Vasetto portafiori  
Flower vase  
Soliflore  
Blumenvase  
Florero

H cm. 14 H 5 1/2"

81601

81602



mm. 3,0 Allacciatovaglioli  
Napkins ring  
Rond de serviettes  
Serviettenring  
Servilletero Ø cm. 9 Ø 3 1/2"

mm. 3,0 Allacciatovaglioli  
Napkins ring  
Rond de serviettes  
Serviettenring  
Servilletero Ø cm. 9 Ø 3 1/2"

81603

81604



mm. 3,0 Allacciatovaglioli  
Napkins ring  
Rond de serviettes  
Serviettenring  
Servilletero cm. 9 x 8 3 1/2" x 3 1/7"

mm. 3,0 Allacciatovaglioli  
Napkins ring  
Rond de serviettes  
Serviettenring  
Servilletero cm. 8 x 8 3 1/7" x 3 1/7"

81605

81606



mm. 3,0 Allacciatovaglioli  
Napkins ring  
Rond de serviettes  
Serviettenring  
Servilletero cm. 8 x 8 3 1/7" x 3 1/7"

mm. 3,0 Allacciatovaglioli  
Napkins ring  
Rond de serviettes  
Serviettenring  
Servilletero cm. 10 x 7 4" x 2 5/8"

812



mm. 1,2 Formaggera  
Parmesan cheese basin  
Fromagère  
Parmesan Menage  
Quesera Azucarero

Ø cm. 14  
cl. 20

Ø 5 1/2"  
oz. 6 3/4

811



mm. 1,2 Completo oliera con spargisale  
Cruet and salt cellar set  
Service huile-vinaigre 4pcs.  
Menage 4-Tlg.  
Convoy vinagreras con saleros  
4 pzas.

H cm. 19,6  
Ø cm. 21  
cl. 76

H 7 3/4"  
Ø 8 1/4"  
oz. 25 3/4

85402



mm. 1,2 Portachiavi  
Key holder  
Porte-clés  
Schlüsselanhänger  
Portallaves

cm. 8 x 8

3 1/8" x 3 1/8"

852



mm. 1,2 Vassoio rotondo  
Round tray  
Plateau rond  
Tablett rund  
Bandeja redonda

Ø cm. 21

Ø 8 1/4"

836



mm. 1,2 Portabicchieri di carta  
Paper cup holder  
Porte-gobelets de papier  
Papier- und Becherständer  
Portavasos de papel

H cm. 22,5  
cm. 23 x 12,5

H 8 7/8"  
8 7/8" x 4 7/8"

831



mm. 1,2 Portacondimenti con astina  
Basket for aromatic condiments  
Support pour Condiments et  
Aromates  
Ständer für Essig und Öl  
Cestos para aromaticos y  
condimentos

H cm. 33  
cm. 15 x 15

H 13"  
5 7/8" x 5 7/8"

411



mm. 1,2  
Caffetteria  
Coffee pot  
Cafetière  
Kaffeekanne  
Cafetera

Tazze	2	cl. 25	8 1/2 oz.
Cups	4	cl. 37	12 1/2 oz.
Bols	6	cl. 52	17 5/8 oz.
Tassen	8	cl. 70	23 5/8 oz.
Tazas	10	cl. 100	33 7/8 oz.
	12	cl. 150	50 3/4 oz.
	16	cl. 200	67 5/8 oz.

412



mm. 1,2  
Teiera  
Tea pot  
Théière  
Teekanne  
Tetera

Tazze	4	cl. 55	18 5/8 oz.
Cups	6	cl. 70	23 5/8 oz.
Bols	8	cl. 97	32 3/4 oz.
Tassen			
Tazas			

413



mm. 1,2  
Lattiera  
Milk jug  
Pot à lait  
Milchkanne  
Jarra lechera

Tazze	1	cl. 10	3 3/8 oz.
Cups	2	cl. 25	8 1/2 oz.
Bols	4	cl. 37	12 1/2 oz.
Tassen	6	cl. 52	17 5/8 oz.
Tazas	8	cl. 70	23 5/8 oz.
	10	cl. 100	33 7/8 oz.
	12	cl. 150	50 3/4 oz.
	16	cl. 200	67 5/8 oz.

414



mm. 1,2  
Zuccheriera  
Sugar bowl  
Sucrier  
Zuckerdose  
Azucarero

Tazze	4	cl. 18	6 1/8 oz.
Cups	8	cl. 30	10 1/8 oz.
Bols			
Tassen			
Tazas			

7063



Candelabro a 3 fiamme H cm. 23,6  
Candelabra, 3 arms  
Chandelier 3 flammes H 9 1/4"  
Kerzenständer für 3  
Kerzen  
Candelabro 3 luces

85303



mm. 3,0  
Segnaposto  
Table number stand  
Marqueur de table  
Tischnummern-Ständer  
Numero de mesa

H cm. 8 H 3 1/8"  
cm. 8 x 8 3 1/8" x 3 1/8"

# Original Vintage



Gli articoli di queste pagine, sono già disponibili in magazzino nella versione antichizzata, PELTRO. Tutti gli altri articoli possono essere forniti in versione PELTRO, a richiesta, senza quantità minima

The items on these pages are already available in stock in the antiqued PELTRO version. All the other items can be supplied on request in the PELTRO version, without minimum quantity.

Les articles des cettis pages sont déjà disponible en stock dans la version avec la surface vieillie, PELTRO. Tous les autres articles peuvent être fournis en version PELTRO, sur demande, sans quantité minimum.

Die Artikeln auf diese Seiten sind Ausführungen in der antiken, Oberfläche PELTRO auf Lager bereits. Alle anderen Artikeln können auf Anfrage ohne Mindestmenge in der PELTRO-Version geliefert werden

Los artículos de estas páginas son ya disponibles en el almacén en la versión PELTRO, con la superficie envejecida. Todos los otros artículos se pueden suministrar en la versión PELTRO, bajo pedido, sin cantidad mínima.



187

186



Portauovo  
Egg-cup  
Coquetier  
Eierbecher  
Huevera  
mm. 1,2

cm. 15 x 9  
5 7/8" x 3 1/2"



Mini burriera  
Mini Butter dish  
Mini Beurrier  
Mini Butterdose mit  
Deckel  
Mini Mantequera  
mm. 1,2

cm. 12 x 6  
cl. 15  
4 3/4" x 2"  
oz. 6

184

178



Salsiera  
Gravy boat  
Saucière  
Sauciere  
Salsera  
mm. 1,2

cl. 30  
oz. 10 1/8



Saucière  
cl. 4  
oz. 1 3/8  
mm. 1,2

173

177



Piatto ovale da portata pesce  
bordo rinforzato  
Oval serving fish plate  
with reinforced edges  
Plat à poisson oval bord renforcé  
Fischplatte, oval  
Fuente pescado borde reforzado  
mm. 1,2

cm. 55 x 24  
cm. 70 x 29  
21 5/8" x 9 1/2"  
27 1/2" x 11 3/8"



Piatto ovale da portata  
bordo rinforzato  
Oval serving plate  
with reinforced edges  
Plat oval bord renforcé  
Bratenplatte, oval  
Fuente ovalada borde reforzado  
mm. 1,2

cm. 30 x 21  
cm. 40 x 27  
cm. 50 x 35  
11 3/4" x 8 1/4"  
15 3/4" x 10 5/8"  
27 1/2" x 11 3/8"

172



Vassoio rettangolare per  
pasticceria  
Rectangular tray for cakes  
Plat à tarte rectangulaire  
Gebäckplatte, rechteckig  
Bandeja  
mm. 0,6

cm. 26 x 19  
cm. 31 x 21  
10 1/4" x 7 1/2"  
12 1/4" x 8 1/4"

182

174



Vassoio per gratin  
Tray for "gratin"  
Plat à "gratin"  
Gratinplatte  
Bandeja gratinar  
mm. 1,2

cm. 35 x 20  
cm. 40 x 24  
13 3/4" x 7 1/8"  
15 3/4" x 9 1/2"

181



Vassoio per gratin e gastronomia  
Tray for "Gratin-gastronomy"  
Plat à "Gratin et gastronomie"  
Gratinplatte für Gastronomie  
Bandeja para gratinar y gastronomia  
mm. 1,2

cm. 30 x 22  
cm. 40 x 29  
11 3/4" x 8 5/8"  
15 3/4" x 11 3/8"



Piatto rotondo da portata  
bordo rinforzato  
Round serving plate  
with reinforced edges  
Plat rond de service bord  
renforcé  
Bratenplatte, rund  
Bandeja redonda borde  
reforzado  
mm. 1,2

Ø cm. 27  
Ø cm. 35  
Ø cm. 40  
Ø 10 5/8"  
Ø 13 3/4"  
Ø 15 3/4"



171

170



880



Cestino semitraforato  
Half fretworked basket  
Corbeille demi-ajouré  
Schale, halbgelocht  
Frutero semiperforado

Ø cm. 22  
H cm. 5,7  
cl. 150

Ø 8 5/8"  
H 2 1/4"  
oz. 50 1/4

Scodella lavadita  
Finger bowl  
Ecuelle  
Fingerbowl  
Lavadedos

Ø cm. 12  
cl. 30

Ø 4 3/4"  
oz. 10 1/8

Cestino traforato  
Fretworked basket  
Corbeille ajouré  
Schale, gelocht  
Frutero perforado

Ø cm. 22  
H cm. 5,7  
cl. 150

Ø 8 5/8"  
H 2 1/4"  
oz. 50 1/4

mm. 0,8

mm. 0,6

mm. 0,8

175

874



176



Piatto tondo per legumi a 3 scompi  
3 sections vegetable dish  
Plat à légumes rond - 3 compt.  
Teller rund 3 Abteilungen  
Bandeja para legumbres 3 comp.

Ø cm. 27  
Ø 10 5/8"

Piatto ovale per legumi a 2 scompi  
2 section vegetable dish  
Plat à légumes oval - 2 comp.  
Teller oval, 2 Abteilungen  
Bandeja para legumbres 2 comp.

cm. 30 x 21  
11 3/4" x 8 1/4"

Sottopiatto  
Charger  
Assiette de bienvenue  
Platzteller  
Bajo plato

Ø cm. 33  
Ø 13"

mm. 0,8

mm. 0,8

mm. 1,2

185

884



882



Ciotola con base  
Bowl with base  
Bol avec socle  
Obstschale auf Fuss  
Cuenco con pedestal  
mm. 1,2

Ø cm. 14 - cl. 60  
H cm. 8,8  
Ø cm. 20 - lt. 1,8  
H cm. 11  
Ø cm. 24 - lt. 3,1  
H cm. 14

Ø 5 1/2" - oz. 20 1/2  
H 3 1/2"  
Ø 7 7/8" - oz. 60 7/8  
H 4 1/2"  
Ø 11" - oz. 104 7/8  
H 6 1/3"

Secchio per ghiaccio  
Ice bucket with grill  
Seau à glaçons  
Eisgefäß  
Cubitera hielo  
mm. 1,2

Ø cm. 14  
H.cm.13  
cl. 150  
Ø 5 1/2"  
H 5 1/8"  
oz. 50 3/4

Secchio per spumante  
Sparkling wine cooler  
Seau à champagne  
Wein-und Sektkühler  
Cubo para champany  
mm. 1,2

Ø cm.23  
H cm.22,5  
lt. 8,5  
Ø 9"  
H 8 7/8"  
gal. 2 1/4

188

180

881

179



Tegamino friggiuova  
Frying pan for eggs  
Plat à oeuf  
Eierpfanne  
Plato huevos

Ø cm. 16

Ø 6 1/4"

mm. 0,8

Coppa per gelato  
Ice-cream bowl  
Coupe à glace  
Eisschale  
Copa helado

Ø cm. 8,5  
cl. 15

Ø 3 1/3"  
oz. 5

mm. 0,6

Molla per arrosto e verdure  
Roasts and vegetables tongs  
Pince à salade et à rôti  
Servierzange  
Pinzas asado y verduras

cm. 21

8 1/4"

mm. 0,8

Molla per spaghetti  
Spaghetti/Pasta tongs  
Pince à spaghetti  
Spaghettizange  
Pinzas spaghetti

cm. 21

8 1/4"

mm. 0,6

87504

87508



mm. 1,2

Bricco  
Jug  
Cruche  
Milchkanne  
Jarra

Tazze 4  
Cups  
Bols  
Tassen  
Tazas

cl. 40

13 1/2 oz.

mm. 1,2

Bricco  
Jug  
Cruche  
Milchkanne  
Jarra

Tazze 8  
Cups  
Bols  
Tassen  
Tazas

cl. 70

23 5/8 oz.

87802

87908



mm. 1,2

Bricco  
Jug  
Cruche  
Milchkanne  
Jarra

Tazze 2  
Cups  
Bols  
Tassen  
Tazas

cl. 25

8 1/2 oz.

mm. 1,2

Zuccheriera  
Sugar bowl  
Sucrier  
Zuckerdose  
Azucarero

Tazze 8  
Cups  
Bols  
Tassen  
Tazas

cl. 30

10 1/8 oz.



Tendence

609



mm. 1,2  
Piano  
Tray  
Plateau  
Tablett oval  
Bandeja

cm. 40 x 36 15 3/4" x 14 1/8"

612



mm. 1,2  
Piano forato  
Tray fretworked handles  
Plateau avec anses ajourée  
Grifftablett oval  
Bandeja asa perforada

cm. 40 x 36 15 3/4" x 14 1/8"

613



mm. 1,2  
Fondo  
Bowl  
Bol  
Brotschale oval  
Cuenco

cm. 22 x 20 8 5/8" x 7 7/8"  
cl. 80 oz. 27

cm. 40 x 36 15 3/4" x 14 1/8"  
lt. 4,0 gal. 1

614



mm. 1,2  
Fondo forato  
Bowl fretworked handles  
Bol avec anses ajourée  
Griffschale oval  
Cuenco asa perforada

cm. 22 x 20 8 5/8" x 7 7/8"  
cl. 49 oz. 16 1/2

cm. 40 x 36 15 3/4" x 14 1/8"  
lt. 2,6 oz. 87 7/8

617



mm. 1,2  
Sottopiatto ovale  
Charger oval  
Assiette de bienvenue ovale  
Platzteller oval  
Bajo plato oval

cm. 34 x 31 13 3/8" x 12 1/4"  
cm. 39 x 36 15 3/8" x 14 1/8"

616AC



mm. 1,2  
Piattino per pane  
Bread tray  
Plat pour pan  
Brot Platte  
Plato para pan

cm. 14 x 12 5 1/2" x 4 3/4"

561



mm. 1,2 Rettangolare piano  
Rectangular tray  
Plateau rectangulaire  
Tablett, rechteckig  
Bandeja rectangular

cm. 23 x 13 9" x 5 1/8"  
cm. 38 x 25 15" x 9 7/8"

562



mm. 1,2 Rettangolare fondo  
Rectangular bowl  
Bol rectangulaire  
Obstschale, rechteckig  
Cuenco rectangular

cm. 38 x 25 15" x 9 7/8"  
H cm. 5,1 H 2"  
cl. 300 oz. 101 1/2

557



mm. 1,2 Ovale piano  
Oval tray  
Plateau, oval  
Tablett, oval  
Bandeja oval

cm. 37 x 25 14 1/2" x 9 7/8"  
cm. 46 x 31 18 1/8" x 12 1/4"

558



mm. 1,2 Ovale fondo  
Oval bowl  
Bol oval  
Obstschale, oval  
Cuenco oval

cm. 37 x 25 14 1/2" x 9 7/8"  
H cm. 6,3 H 2 1/2"  
cl. 250 oz 84 1/2  
cm. 46 x 31 18 1/8" x 12 1/4"  
H cm. 6,3 H 2 1/2"  
cl. 400 gal. 1

563



mm. 1,2 Quadro piano  
Square tray  
Plateau carré  
Tablett, quadratisch  
Bandeja cuadrada

cm. 15 x 15 5 7/8" x 5 7/8"  
cm. 22 x 22 8 5/8" x 8 5/8"

564



mm. 1,2 Quadro fondo  
Square bowl  
Bol carré  
Schale, quadratisch  
Cuenco cuadrado

cm. 15 x 15 5 7/8" x 5 7/8"  
H cm. 4,9 H 2"  
cl. 50 oz. 16 7/8  
cm. 22 x 22 8 5/8" x 8 5/8"  
H cm. 4,9 H 2"  
cl. 150 oz. 50 3/4

559



mm. 1,2 Tondo piano Ø cm. 12 Ø 4 3/4 "  
 Wine bottle coaster  
 Plateau ronde  
 Tablett rund  
 Bandeja redonda

560



mm. 1,2 Tondo fondo Ø cm. 12 cl. 26 Ø 4 3/4" oz. 8 3/4  
 Round bowl H cm. 3,9 H 1 1/2"  
 Bol ronde Ø cm. 15 cl. 60 Ø 5 7/8" oz. 20 1/4  
 Obstschale, rund H cm. 5 H 2"  
 Cuenco redondo Ø cm. 22 cl. 131 Ø 8 5/8" oz. 44 1/3  
 H cm. 5,8 H 2 1/4"  
 Ø cm. 32 lt. 3,0 Ø 12 5/8" oz. 101 2/5  
 H cm. 6,8 H 2 2/3"

568



mm. 1,2 Posacenere ad acqua Ø cm. 12 Ø 4 3/4 "  
 Water ashtray cl. 26 oz 8 4/5  
 Cendrier à eau  
 Wasseraschen rund  
 Cenicero ad agua

569



mm. 1,2 Posacenere ad acqua cm. 15 x 15 5 7/8" x 5 7/8"  
 Water ashtray cl. 50 oz 16 7/8  
 Cendrier à eau  
 Wasseraschen quadrat.  
 Cenicero ad agua

567

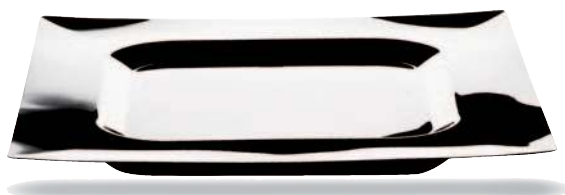

mm. 1,2 Sottopiatto cm. 32 x 32 12 5/8" x 12 5/8"  
 Charger  
 Assiette de bienvenue  
 Platzteller  
 Bajo plato

870



mm. 1,2 GIOTTO cm. 35,5 x 11 14" x 4 1/3"  
 Portapane / Portagrissini  
 Bread / Bread sticks holder  
 Porte pan / Porte gressini  
 Brot und-Grissini -Schale  
 Portapan / Porta bastoncillos de

596

599



608

mm. 1,2 Cestini traforati  
Fretworked baskets  
Corbeilles, ajourées  
Früchtekorb gelocht  
Cestas perforadas

**596**  
Ø cm. 16,8  
H cm. 11  
cl. 150

Ø 6 5/8"  
H 4 3/8"  
oz. 50 3/4

**608**  
Ø cm. 27  
H cm. 13,5  
lt. 5

Ø 10 1/2"  
H 5 1/4"  
gal. 1 1/3

**599**  
Ø cm. 29  
H cm. 18,5  
lt. 8

Ø 11 3/8"  
H 7 1/4"  
gal. 2

730



mm. 1,2 Spumantiera 12 bottiglie champagne  
Giant champagne bucket for 12 bottles  
Seau à champagne géante pour 12 bouteilles  
Champagner Bowl für 12 Flaschen  
Cubo de champagne gigante para 12 botellas

cm. 75 x 65  
H cm. 19  
lt. 15

29 1/2" x 25 5/8"  
H 7 1/2"  
gal. 3 7/8

438

689

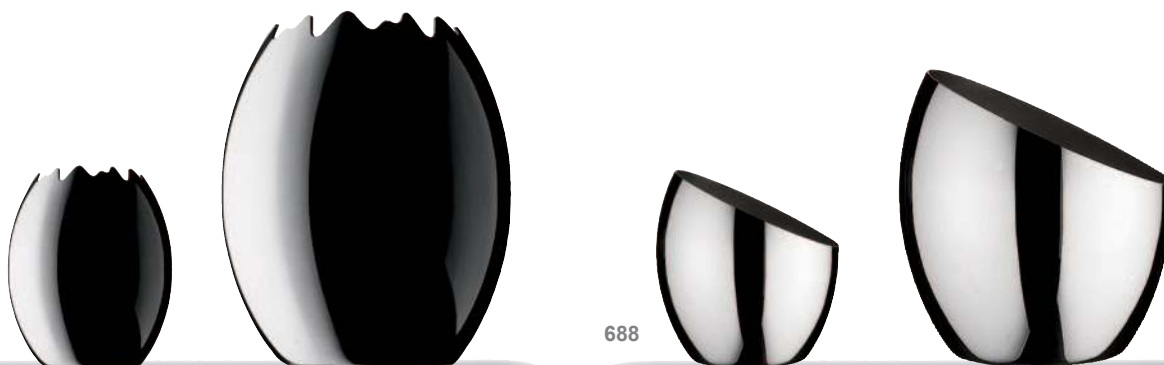

439

mm. 1,2  
**OVETTO**  
Secchiello per ghiaccio  
Ice-bucket  
Seau à glaçons  
Eisgefäß  
Cubitera hielo

Ø cm. 11  
H cm. 13  
cl. 100

Ø 4 3/8"  
H 5 1/8"  
oz. 33 7/8

mm. 1,2  
**OVO**  
Secchiello per spumante  
Sparkling wine cooler  
Seau à champagne  
Wein- und Sektkühler  
Cubo para champany

Ø cm. 19  
H cm. 22  
lt. 4,5

Ø 7 1/2"  
H 8 5/8"  
gal. 1 1/4

688

mm. 1,2  
**Secchiello per ghiaccio**  
Ice-bucket  
Seau à glaçons  
Eisgefäß  
Cubitera hielo

Ø cm. 11  
H cm. 12,5  
cl. 55

Ø 4 3/8"  
H 4 7/8"  
oz. 18 5/8

mm. 1,2  
**Secchiello per spumante**  
Sparkling wine cooler  
Seau à champagne  
Wein- und Sektkühler  
Cubo para champany

Ø cm. 19  
H cm. 20  
lt. 2,5

Ø 7 1/2"  
H 7 3/4"  
oz. 84 1/2

598



607



597

mm. 1,2 Cestini  
Baskets  
Corbeilles  
Früchtekorben  
Cestas

**598**  
Ø cm. 29    Ø 11 3/8"  
H cm. 18,5    H 7 1/4"  
lt. 8            gal. 2

**607**  
Ø cm. 27    Ø 10 1/2"  
H cm. 13,5    H 5 1/4"  
lt. 5            gal. 1 1/3

**597**  
Ø cm. 16,8    Ø 6 5/8"  
H cm. 11        H 4 3/8"  
cl. 150         oz. 50 3/4

666C

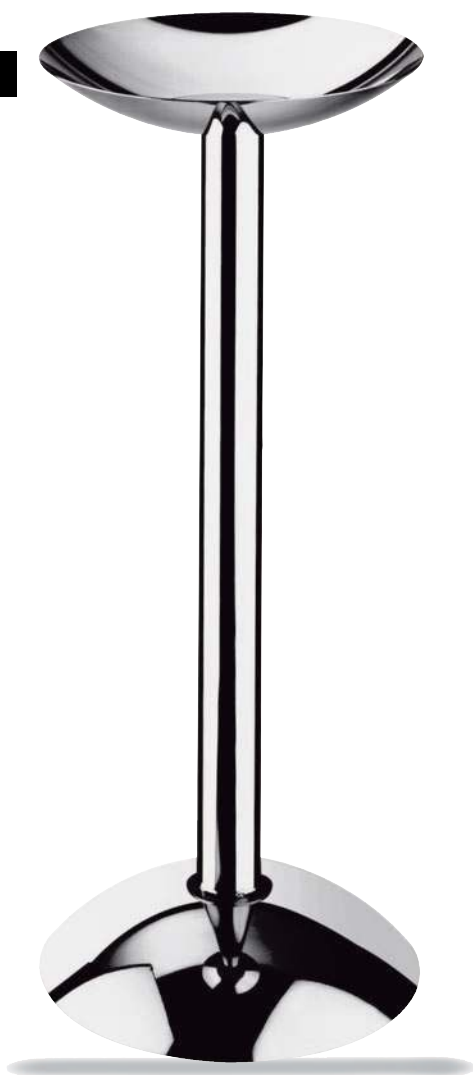

mm. 1,2 UNO  
Colonna portasecchiello spumante  
Wine cooler stand  
Pied pour seu à champagne  
Weinkühlerständer  
Columna porta cubo champany

H cm. 65    H 25 5/8"

912



909

mm. 1,2  
Secchiello per spumante  
Sparkling wine cooler  
Seau à champagne  
Wein- und Sektkühler  
Cubo para champany

cm. 39 x 36  
H cm. 17,5  
lt. 6  
15 3/8" x 14 1/4"  
H 7"  
gal. 1 3/5

mm. 1,2  
Secchiello per ghiaccio  
Ice-bucket  
Seau à glaçons  
Eisgefäß  
Cubitera hielo

cm. 22 x 20  
H cm. 11,5  
lt. 1,2  
H 4 5/8"  
8 3/4" x 7 7/8"  
oz. 40 1/2

910



899

mm. 1,2  
Secchiello per spumante  
Sparkling wine cooler  
Seau à champagne  
Wein- und Sektkühler  
Cubo para champany

cm. 39 x 36  
H cm. 17,5  
lt. 7  
15 3/8" x 14 1/4"  
H 7"  
gal. 1 4/5

mm. 1,2  
Secchiello per ghiaccio  
Ice-bucket  
Seau à glaçons  
Eisgefäß  
Cubitera hielo

cm. 22 x 20  
H cm. 11,5  
lt. 1,6  
8 3/8" x 7 7/8"  
H 4 5/8"  
oz. 54

570



mm. 1,2  
Cremiera  
Cream jug  
Crémier  
Sahnegießer/Milchkännchen  
Jarrita lechera

Ø cm. 6    Ø 2 3/8"  
H cm. 8,8    H 3 1/2"  
cl. 16        oz 5 3/8

571



mm. 1,2  
Zuccheriera  
Sugar bowl  
Sucriere  
Zuckerdose  
Azucarero

Ø cm. 9,5    Ø 3 3/4"  
H cm. 6,8    H 2 3/4"  
cl. 20        oz 6 3/4

514



mm. 0,8  
GIOTTO  
Spargisale e Spargipepe  
Salt and pepper cellar  
Salière et poivrère  
Salz und Pepper-streuer  
Salero y pimentero

Ø cm. 3        Ø 1 1/6"  
H cm. 3        H 1 1/6"  
cl. 5            oz. 1 2/3

999C

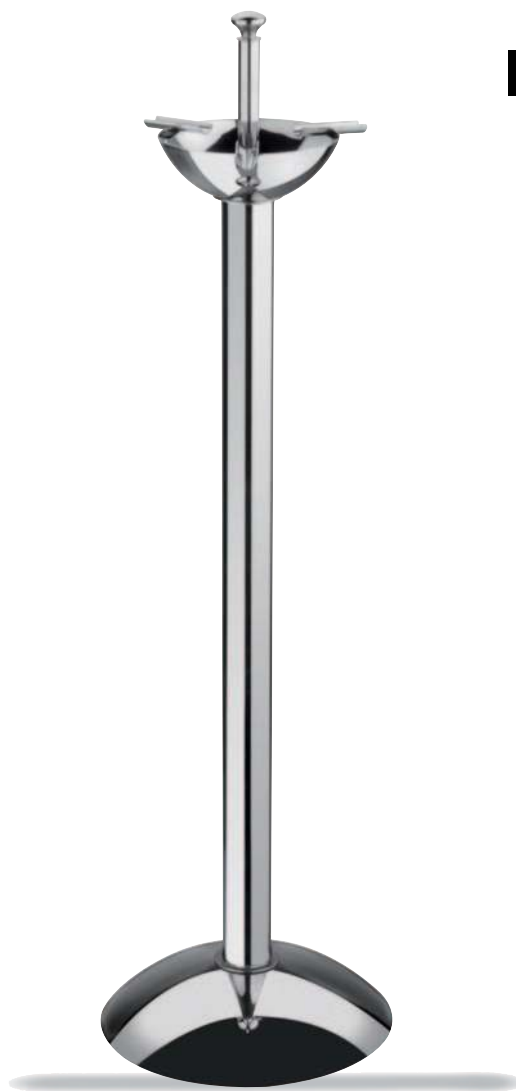

719



mm. 1,2  
Bicchiere termico  
Insulated shot glass  
Shot-verre thermique  
Warmhalter Shot Glass  
Vaso térmico por chupito

Ø cm. 5 Est.    Ø 2"    Out.  
Ø cm. 4 Int.    Ø 1 3/5" Ins.  
H cm. 6,3        H 2 1/2"  
cl. 6              oz. 2

mm. 1,2  
Posacenere a colonna  
Ashtray column  
Borne étouffoir  
Ascherständer  
Cenicero à columna

H cm 91,5    H 36"

26202



mm. 1,2 Centrotavola/Fruttieria ovale 2p cm. 46 x 31 18<sup>1</sup>/<sub>8</sub>" x 12<sup>1</sup>/<sub>4</sub>"  
 Elevated centerpiece/Fruit-bowl cm. 37 x 25 14<sup>1</sup>/<sub>2</sub>" x 9<sup>7</sup>/<sub>8</sub>"  
 Centre de table/Compotier H cm. 28 H 11<sup>1</sup>/<sub>8</sub>"  
 Tafelaufsatz/Obstschale lt. 6,5 gal. 1<sup>5</sup>/<sub>7</sub>  
 Centro de mesa/Fruterio

242



mm. 1,2 Centrotavola/Fruttieria tonda Ø cm. 32 Ø 12<sup>5</sup>/<sub>8</sub>"  
 Elevated centerpiece/Fruit-bowl H cm. 19 H 7<sup>1</sup>/<sub>2</sub>"  
 Centre de table/Compotier lt. 3,0 oz. 101<sup>2</sup>/<sub>5</sub>  
 Tafelaufsatz/Obstschale  
 Centro de mesa/Fruterio

26203



mm. 1,2 Centrotavola/Fruttieria ovale 3p cm. 46 x 31 18<sup>1</sup>/<sub>8</sub>" x 12<sup>1</sup>/<sub>4</sub>"  
 Elevated centerpiece/Fruit-bowl cm. 37 x 25 14<sup>1</sup>/<sub>2</sub>" x 9<sup>7</sup>/<sub>8</sub>"  
 Centre de table/Compotier 3et. Ø cm. 12 Ø 4<sup>3</sup>/<sub>4</sub>"  
 Tafelaufsatz/Obstschale 3-Stu. H cm. 37 H 14<sup>1</sup>/<sub>2</sub>"  
 Centro de mesa/Fruterio 3pisos lt. 6,7 gal. 1<sup>3</sup>/<sub>4</sub>

24202



mm. 1,2 Centrotavola/Fruttieria tonda 2 piani Ø cm. 32 Ø 12<sup>5</sup>/<sub>8</sub>"  
 Elevated centerpiece/Fruit-bowl 2t Ø cm. 22 Ø 8<sup>5</sup>/<sub>8</sub>"  
 Centre de table/Compotier 2 et. H cm. 29,5 H 11<sup>3</sup>/<sub>5</sub>"  
 Tafelaufsatz/Obstschale 2-Stufig lt. 4,3 gal. 1<sup>1</sup>/<sub>8</sub>  
 Centro de mesa/Fruterio 2 pisos

26204



mm. 1,2 Centrotavola/Fruttieria ovale 4p cm. 55 x 24 21<sup>5</sup>/<sub>8</sub>" x 9<sup>1</sup>/<sub>2</sub>"  
 Elevated centerpiece/Fruit-bowl cm. 46 x 31 18<sup>1</sup>/<sub>8</sub>" x 12<sup>1</sup>/<sub>4</sub>"  
 Centre de table/Compotier 4et. cm. 37 x 25 14<sup>1</sup>/<sub>2</sub>" x 9<sup>7</sup>/<sub>8</sub>"  
 Tafelaufsatz/Obstschale 4-Stu. Ø cm. 12 Ø 4<sup>3</sup>/<sub>4</sub>"  
 Centro de mesa/Fruterio 4pisos H cm. 49 H 19<sup>1</sup>/<sub>3</sub>"  
 lt. 7,2 gal. 2

871



mm. 1,2 Cestino portafrutta cm. 24 x 11 9<sup>1</sup>/<sub>2</sub>" x 4<sup>1</sup>/<sub>3</sub>"  
 Fruit basket  
 Panier à fruits  
 Obstschale  
 Cesto porta frutas

# Plateau Royal





252



mm. 1,2 Centrotavola/Fruttieria  
Elevated centerpiece/Fruit-bowl  
Centre de table/Compotier  
Tafelaufsatz/Obstschale  
Centro de mesa/Fruterio

cm.38 x 25 15" x 9 7/8"  
H cm. 18 H 7 1/8"  
cl. 300 oz. 101 1/2

252G



mm. 1,2 Alzata per pesce crudo  
Elevated rect.seafood presentation  
Serveur à poisson crude  
Etagere für marinierten Fisch  
Porta pescado

cm.38 x 25 15" x 9 7/8"  
H cm. 18 H 7 1/8"  
cl. 300 oz. 101 1/2

562V



Rettangolare fondo con vassoio  
Rectangular cooling bowl for buffet with insert  
Bol rectangulaire à rafraichir avec insert  
Kühlschale, rechteckig mit Einsatzeile  
Bandeja refrescante rectangular con inserto

cm. 38 x 25  
cl. 300

15" x 9 7/8"  
oz. 101 1/2

562G



Rettangolare fondo con griglia  
Elevated rect.seafood presentation with grill  
Bol rectangulaire à rafraichir avec grill  
Kühlschale, rechteckig mit Einsatzsieb  
Bandeja refrescante rectangular con rejilla

cm. 38 x 25  
cl. 300

15" x 9 7/8"  
oz. 101 1/2

56422V



Quadro fondo con vassoio  
Square cooling bowl for buffet with insert  
Bol carré à rafraichir avec insert  
Kühlschale, quadr. mit Einsatzeile  
Bandeja refrescante cuadrada con inserto

cm. 22x22  
cl. 150

8 5/8" x 8 5/8"  
oz. 50 3/4

56422G



Quadro fondo con griglia  
Square individual seafood presentation with grill  
Bol carré à rafraichir avec grill  
Kühlschale, quadr. mit Einsatzsieb  
Bandeja refrescante cuadrada con rejilla

cm. 22x22  
cl. 150

8 5/8" x 8 5/8"  
oz. 50 3/4

262G



mm. 1,2 Alzata per pesce crudo  
Elevated oval seafood  
presentation with grill  
Serveur à poisson crude  
Etagere für marinierten Fisch  
Porta pescado

cm. 46 x 31 18 1/8" x 12 1/4"  
H cm. 18 H 7 1/8"  
cl. 400 gal. 1

262



mm. 1,2 Centrotavola/Fruttiere  
Elevated centerpiece/Fruit-bowl  
Centre de table/Compotier  
Tafelaufsatz/Obstschale  
Centro de mesa/Fruterio

cm. 46 x 31 18 1/8" x 12 1/4"  
H cm. 18 H 7 1/8"  
cl. 400 gal. 1

558G



Ovale fondo con griglia  
Oval seafood presentation with grill  
Bol oval à rafraichir avec grill  
Kühlschale, oval mit Einsatzsieb  
Bandeja refrescante oval con rejilla

cm. 46 x 31  
cl. 400  
18 1/8" x 12 1/4"  
gal. 1

558V



Ovale fondo con vassoio  
Oval cooling bowl for buffet with insert  
Bol oval à rafraichir avec insert  
Kühlschale, oval mit Einsatzteile  
Bandeja refrescante oval con inserto

cm. 46 x 31  
cl. 400  
18 1/8" x 12 1/4"  
gal. 1

56022G



Tondo fondo con griglia  
Round individual seafood presentation with grill  
Bol ronde à rafraichir avec grill  
Kühlschale, rund mit Einsatzsieb  
Bandeja refrescante redonda con rejilla

Ø cm. 22  
cl. 150  
Ø cm. 8 5/8"  
oz. 50 3/4

56022V



Tondo fondo con vassoio  
Round cooling bowl for buffet with insert  
Bol ronde à rafraichir avec insert  
Kühlschale, rund mit Einsatzteile  
Bandeja refrescante redonda con inserto

Ø cm. 22  
cl. 150  
Ø cm. 8 5/8"  
oz. 50 3/4

242G



mm. 1,2 Alzata tonda per pesce crudo Ø cm.32 Ø 12 5/8"  
Elevated round thirty-two stand H cm. 19 H 7 1/2"  
Serviteur ronde à poisson crude lt. 3,0 oz. 101 2/5  
Etagere, rund, für marinierte  
Fisch Ø cm.22 Ø 8 5/8"  
Porta pescado redondo H cm. 18 H 7 1/8"  
lt. 1,31 oz. 44 1/3

26202G



mm. 1,2 Alzata ovale per pesce crudo 2p cm. 46 x 31 18 1/8" x 12 1/4"  
Oval two tier seafood stand cm. 37 x 25 14 1/2" x 9 7/8"  
Serviteur ovale à poisson crude H cm. 28 H 11 1/8"  
Etagere, oval, für marinierten lt. 6,5 gal. 1 5/7  
Fisch  
Porta pescado oval 2 pisos

24202G



mm. 1,2 Alzata tonda per pesce crudo 2p Ø cm. 32 Ø 12 5/8"  
Round two tier seafood stand Ø cm. 22 Ø 8 5/8"  
Servit.ronde à poisson crude 2 et. H cm. 29,5 H 11 3/5"  
Etagere, rund, für marinierte Fisch lt. 4,3 gal. 1 1/8  
2-Stufig  
Porta pescado redondo 2 pisos

26203G



mm. 1,2 Alzata ovale per pesce crudo 3p cm. 46 x 31 18 1/8" x 12 1/4"  
Oval three tier seafood stand cm. 37 x 25 14 1/2" x 9 7/8"  
Serviteur ovale à poisson crude Ø cm. 12 Ø 4 3/4"  
Etagere, oval, für marinierten H cm. 37 H 14 1/2"  
Fisch 3 -Stufig lt. 6,7 gal. 1 3/4  
Porta pescado oval 3 pisos

485

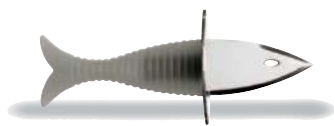

APRIL cm. 15 5 7/8"  
Coltello per ostriche  
Oyster knife  
Couteau à huîtres  
Austernöffner  
Cuchillo de ostras

26204G



mm. 1,2 Alzata ovale per pesce crudo 4p cm. 55 x 24 21 5/8" x 9 1/2"  
Oval four tier seafood stand cm. 46 x 31 18 1/8" x 12 1/4"  
Serviteur ovale à poisson crude cm. 37 x 25 14 1/2" x 9 7/8"  
Etagere, oval, für marinierten Ø cm. 12 Ø 4 3/4"  
Fisch 4-Stufig H cm. 49 H 19 1/3"  
Porta pescado oval 4 pisos lt. 7,2 gal. 2

235G



mm. 1,2 Vassoio rotondo per pesce crudo Ø cm.38 Ø 15"  
 Round seafood tray H cm. 9 H 3 1/2"  
 Plateau rond à poisson crude lt. 3,0 oz. 101 2/5  
 Tablett, rund für marinierten Fisch  
 Porta pescado redondo

235



mm. 1,2 Centrotavola/Fruittiera Ø cm.38 Ø 15"  
 Centerpiece/Fruit-bowl H cm. 9 H 3 1/2"  
 Centre de table/Compotier lt. 3,0 oz. 101 2/5  
 Tafelaufsatz/Obstschale  
 Centro de mesa/Fruterio





# Finger Food

10001129



mm. 2,5 Quarta posata

Lungh. cm. 22,2 Length 8 3/4"

25506



mm. 1,2 Micro presentoir

H cm. 13 H 5 1/9"  
 Ø cm. 6 (x5) Ø 2 1/3" (x5)  
 Ø cm. 8 Ø 3 1/7"

25508



mm. 1,2 Mini presentoir

H cm. 17 H 6 5/8"  
 Ø cm. 8 (x5) Ø 3 1/7" (x5)  
 Ø cm. 11 Ø 4 3/8"



10341146

NEW



mm. 3,0 Cucchiaino multifunzione  
 Multifunctional spoon  
 Cuillère multifonctionnelle  
 Multifunktionaler Löffel  
 Cuchara multifuncional

cm. 17,6 6 8/9"

537

53706

53712



mm. 1,2 Mini vassoio quadro 6/12 comp. cm. 12 x 12 4 3/4" x 4 3/4"  
6/12 comp. Mini square tray cm. 15 x 15 5 7/8" x 5 7/8"  
Mini plateau carré 6/12 pos.  
Mini Tablett, eckig., 6/12 Eins.  
Mini bandeja cuadrada 6/12 p.

549



mm. 1,2 Vassoio rettangolare 14 comp. cm 45 x 28 17 3/4" x 11 1/8"  
Rectangular tray 14 comp.  
Plateau rectangulaire 14 plac.  
Tablett, rechteckig 14 Eins.  
Bandeja rectangular 14 posic.

520



mm. 1,2 Vassoio ovale 9 compart. cm. 35 x 25,5 13 3/4" x 10"  
Oval tray 9 compartments  
Plateau oval 9 comp.  
Tablett, oval, 9 Einsätze  
Bandeja oval 9 posiciones

791E

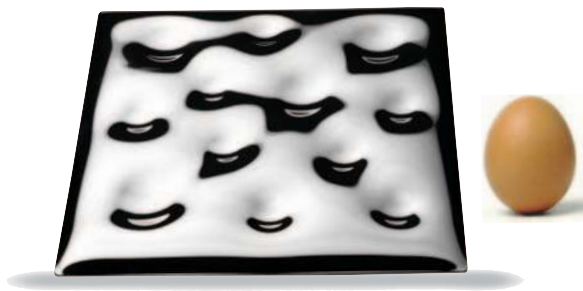

mm. 1,2 Vassoio da buffet per uova cm. 30 x 30 11 7/8" x 11 7/8"  
Egg tray for buffet  
Plateau à oeufs pour buffet  
Egg-tablett für Buffet  
Bandeja porta huevos por buffet

52922



mm. 1,2 Vassoio quadro 8 compart. cm. 22 x 22 8 5/8" x 8 5/8"  
8 comp. Square tray  
Plateau carré 8 pos.  
Tablett, eckig., 8 Eins.  
Bandeja cuadrada 8 posic.

526



mm. 1,2 Vassoio rettangolare a 3 o 4 comp. cm. 23 x 13 9" x 5 1/8"  
Rectangular tray 3 or 4 comp.  
Plateau rectangulaire 3 ou 4 plac.  
Tablett, rechteckig 3 oder 4 Eins.  
Bandeja rectangular 3 o 4 posic.

# FINGER FOOD

791AC

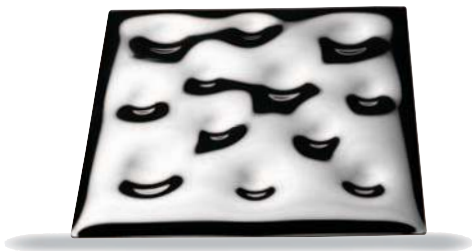

mm. 1,2 Insetto per finger food  
Finger food insert  
Insért pour finger food  
Finger food Einsatz  
Insetto por finger food

cm. 30 x 30 117/8" x 117/8"

791



Vassoio/Sottopiatto  
Square Tray/Charger  
Plateau/Assiette de bienvenue  
Tablett/Platzteller,  
Bandeja/Bajo plato

cm. 32 x 32 12<sup>3</sup>/<sub>4</sub>" x 12<sup>3</sup>/<sub>4</sub>"

700



mm. 1,2 Portapatatine fritte  
French fry holder for table  
Porte pommes frites pour table  
Kartoffenbehälter für Tisch  
Porta patatas fritas por mesa

H cm 10 H 4"  
cl. 35 oz. 11 7/8

902



mm. 1,2 Portapatatine fritte  
French fry holder for table  
Porte pommes frites pour table  
Kartoffenbehälter für Tisch  
Porta patatas fritas por mesa

H cm 8 H 3 1/4"  
Ø cm 7 Ø 2 3/4"

260



mm. 1,2 Portapatatine fritte  
French fry holder for table  
Porte pommes frites pour table  
Kartoffenbehälter für Tisch  
Porta patatas fritas por mesa

Ø cm 10 H 3 3/4"  
H cm 9,5 Ø 3 7/8"

289



mm. 1,2 Portapatatine fritte  
French fry holder for table  
Porte pommes frites pour table  
Kartoffenbehälter für Tisch  
Porta patatas fritas por mesa

H cm. 10 H 3 7/8"  
Ø cm. 6 Ø 2"

53012



mm. 1,2 23053012  
 Mini vaporiera  
 Mini steamer  
 Mini vaporisateur  
 Mini Verdampfer  
 Mini vaporizador

Ø cm. 12      Ø 4 3/4"  
 H cm. 14,5      H 5 3/4"  
 cl. 24      oz. 8

53022



mm. 1,2 23053022  
 Vaporiera  
 Steamer  
 Vaporisateur  
 Verdampfer  
 Vaporizador

Ø cm. 32      Ø 12 5/8"  
 H cm. 26      H 10 1/4"  
 lt. 3,0      oz. 101 2/5



# FINGER FOOD

557T



557

557T

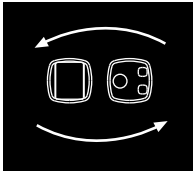

Combinabile con  
Ciotole in vetro  
Ciotole in policarbonato  
Ciotole in porcellana  
Coperchio in acciaio  
inossidabile 18/10

Combinable with  
Glass bowls  
Polycarbonate bowls  
China bowls  
18/10 st.st. lid

Combinable avec  
Bols en verre  
Bols en Polycarbonat  
Bols en porcelaine  
Couvercle en acier  
inoxydable18/10

Kombinierbar mit  
Glasschalen  
Polycarbonatschalen  
Porzellanschalen  
18/10-Deckel

Combinable con  
Cuencos en cristal  
Cuencos en policarbonato  
Cuencos en China  
Tapa en acero inoxidable  
18/10

561M



56138

561M

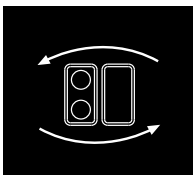

Combinabile con  
Ciotole in vetro  
Ciotole in policarbonato  
Vassoio in acciaio  
inossidabile 18/10

Combinable with  
Glass bowls  
Polycarbonate bowls  
Tray in 18/10  
stainless steel

Combinable avec  
Bols en verre  
Bols en Polycarbonat  
Plateau en acier  
inoxydable18/10

Kombinierbar mit  
Glasschalen  
Polycarbonatschalen  
Edelstahlschalen

Combinable con  
Cuencos en cristal  
Cuencos en policarbonato  
Cuencos en acero  
inoxidable 18/10

561T



561T

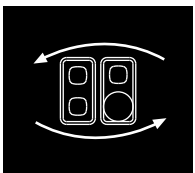

Combinabile con  
Ciotole in vetro  
Ciotole in policarbonato  
Ciotole in porcellana  
Coperchio in acciaio  
inossidabile 18/10  
Ampolle in vetro  
Piatti in vetro

Combinable with  
Glass bowls  
Polycarbonate bowls  
China bowls  
18/10 st.st. lid  
Glass bottles  
Glass trays

Combinable avec  
Bols en verre  
Bols en Polycarbonat  
Bols en porcelaine  
Couvercle en acier  
inoxydable18/10  
Bouteilles en verre  
Plateaus en verre

Kombinierbar mit  
Glasschalen  
Polycarbonatschalen  
Porzellanschalen  
18/10-Deckel  
Karaffen  
Glasplatten

Combinable con  
Cuencos en cristal  
Cuencos en policarbonato  
Cuencos en China  
Tapa en acero inoxidable  
18/10  
Botellas en vidrio  
Platos en vidrio



56122

561M

561T

# FINGER FOOD



**563T15**

**56315**

**563T15**

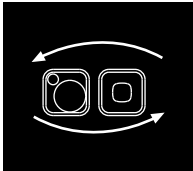

Combinabile con  
Ciotole in vetro  
Ciotole in policarbonato  
Ciotole in porcellana  
Coperchio in acciaio  
inossidabile 18/10  
Ampolle in vetro

Combinable with  
Glass bowls  
Polycarbonate bowls  
China bowls  
18/10 st.st. lid  
Glass bottles

Combinable avec  
Bols en verre  
Bols en Polycarbonat  
Bols en porcelaine  
Couvercle en acier  
inoxydable 18/10  
Bouteilles en verre

Kombinierbar mit  
Glasschalen  
Polycarbonatschalen  
Porzellanschalen  
18/10-Deckel  
Karaffen

Combinable con  
Cuencos en cristal  
Cuencos en policarbonato  
Cuencos en China  
Tapa en acero inoxidable  
18/10  
Botellas en vidrio



**563T22**

**56322**

**563T22**

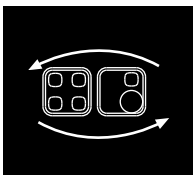

Combinabile con  
Ciotole in vetro  
Ciotole in policarbonato  
Ciotole in porcellana  
Coperchio in acciaio  
inossidabile 18/10  
Ampolle in vetro

Combinable with  
Glass bowls  
Polycarbonate bowls  
China bowls  
18/10 st.st. lid  
Glass bottles

Combinable avec  
Bols en verre  
Bols en Polycarbonat  
Bols en porcelaine  
Couvercle en acier  
inoxydable 18/10  
Bouteilles en verre

Kombinierbar mit  
Glasschalen  
Polycarbonatschalen  
Porzellanschalen  
18/10-Deckel  
Karaffen

Combinable con  
Cuencos en cristal  
Cuencos en policarbonato  
Cuencos en acero  
inoxidable 18/10  
Botellas en vidrio



**563T22**

**567**

**563T22**

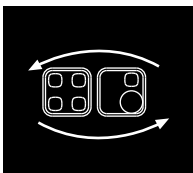

Combinabile con  
Ciotole in vetro  
Ciotole in policarbonato  
Ciotole in porcellana  
Coperchio in acciaio  
inossidabile 18/10  
Ampolle in vetro

Combinable with  
Glass bowls  
Polycarbonate bowls  
China bowls  
18/10 st.st. lid  
Glass bottles

Combinable avec  
Bols en verre  
Bols en Polycarbonat  
Bols en porcelaine  
Couvercle en acier  
inoxydable 18/10  
Bouteilles en verre

Kombinierbar mit  
Glasschalen  
Polycarbonatschalen  
Porzellanschalen  
18/10-Deckel  
Karaffen

Combinable con  
Cuencos en cristal  
Cuencos en policarbonato  
Cuencos en acero  
inoxidable 18/10  
Botellas en vidrio



**578**

**577**

**584**

**587**

**585**

**572**

**572A**

**352**

A close-up photograph of a silver heart-shaped mold being used to pour red wine into a heart-shaped dish. The mold is held by a hand, and the wine is being poured from a white pitcher into the mold. The mold is placed on a white napkin, which is on a white tray. The tray is on a wooden surface. The wine is a deep red color. The mold has a handle and a small hole at the top. The dish is a shallow, heart-shaped metal container. The napkin has a subtle embossed pattern. The tray has a decorative border. The background is a wooden surface with a grain pattern.

748  
Porta sorpresa

Specialist



260 Vaso

703AC Piattino



744  
Cestino

750  
Microforchetta



920  
Appoggia posate

753  
Alzata



919  
Cestino Palace



Quarta Posata

754  
Vassoio

748



mm. 1,2 Porta sorpresa  
Surprises set  
Porte-surprises  
Universalträger  
Puerta sorpresas

703AC



mm. 1,2 Piattino  
Tray  
Plat  
Tablett  
Bandeja  
Ø cm. 10 Ø 3 7/8"

260



mm. 1,2 Vaso  
Jar  
Vase  
Vase  
Florero  
H cm. 9,5 H 3 3/4"  
Ø cm. 10 Ø 3 7/8"

744



mm. 1,2 Cestino  
Basket  
Corbeille  
Früchtekorb  
Cesta  
H cm. 11,5 H 4 1/2"  
Ø cm. 10 Ø 3 7/8"

750



mm. 1,5 Micro forchetta  
Micro fork  
Micro fourchette  
Mikrogabel  
Micro tenedor

743



mm. 1,2 Cestino  
Basket  
Corbeille  
Früchtekorb  
Cesta  
H cm. 11,5 H 4 1/2"  
Ø cm. 10 Ø 3 7/8"

753



mm. 1,2 Alzata  
Holder  
Serviteur  
Etagere  
Frutero  
H cm. 16 H 6 1/3"  
Ø cm. 12 Ø 4 3/4"

920



mm. 1,2 Appoggia posate cm. 10 x 8 4" x 3 1/7"  
Knife rest  
Soutier p/couverts  
Besteck Ablage  
Apoyo p/cubiertos

919



mm. 1,2 Cestino con maniglie  
Basket with handles  
Corbeille avec poignée  
Schale mit Griffen  
Frutero con asas  
H cm. 11,5 H 4 1/2"  
Ø cm. 12 Ø 4 3/4"  
cl. 26 oz 8 4/5

754



mm. 1,2 Vassoio con fori  
Tray with holes  
Plateau avec trous  
Tablett mit Löchern  
Bandeja con agujeros  
Ø cm. 28,5 Ø 11 1/5"

523



mm. 1,2 Mini cestello con coperchio  
Mini basket with lid  
Mini corbeille avec couvercle  
Mini Schale mit Deckel  
Mini cuenco con tapa  
H cm. 10 H 4"  
Ø cm. 9,4 Ø 3 5/7"

739



mm. 1,2 Cestino con coperchio  
Basket with lid  
Corbeille avec couvercle  
Schale mit Deckel  
Cuenco con tapa  
H cm. 16 H 6 1/3"  
Ø cm. 12 Ø 4 3/4"  
cl. 26 oz 8 4/5

718



mm. 1,2 Tumbler

H cm. 8,2 H 3 1/4"  
 Ø cm. 7,2 Ø 3 4/5"  
 cl. 30 oz. 10 1/7

916



mm. 1,2 Poggia pane  
 Tray for bread  
 Plateau pour pan  
 Brot Tablett  
 Bandeja por pan

Ø cm. 19,7 Ø 7 3/4"

918

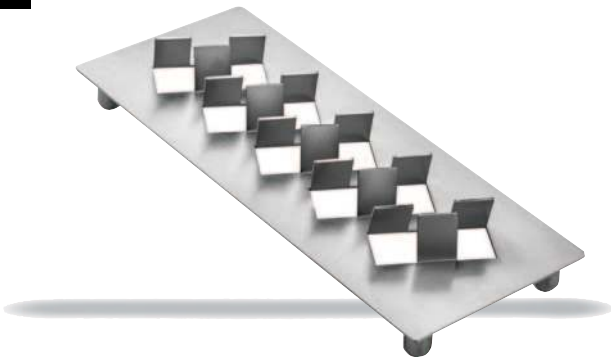

mm. 1,2 Porta crackers  
 Crackers holder  
 Porte craquelins  
 Cracker Schale  
 Puerta galletas saladas

cm. 20 x 8 7 7/8" x 3 1/7"

872



mm. 1,2 Portagrissini  
 Bread sticks tray  
 Porte gressin  
 Grissini Schale  
 Cuenco porta bastoncillos  
 de pan

cm. 24 x 6 H 9 3/8" x 2 2/3"

717



mm. 1,2 Saucière cl. 4 oz. 4

738



mm. 1,2 GIOTTO  
 Coppetta con vassoio  
 Cup and tray  
 Coupe avec plateau  
 Schale mit Tablett  
 Cuenco con bandeja

Ø cm. 9  
 Ø 3 1/2"

Coppetta amouse bouche  
 Appetizer bowl  
 Bol multi-usages  
 Fingerfood-/Vorspeisen-/Butter-  
 Gefäß  
 Cuenco para finger food/amouse  
 bouche

cm. 13 x 7  
 cl. 4  
 5 1/9" x 2 3/4"  
 oz. 4

740



745  
Vassoio  
petit four



742  
Piattino pasticceria



747  
Porta bon bon



Vassoio petit four  
745



990  
Coppetta con vassoio



745  
Vassoio petit four



742  
Piattino  
pasticceria



746  
Vassoietto  
petit four

914



mm. 1,2 PALACE  
Vassoietto  
Tray  
Plateau  
Tablett  
Bandeja

cm. 13 x 7 5 1/9" x 2 3/4"

737



mm. 1,2 GIOTTO  
Vassoietto  
Tray  
Plateau  
Tablett  
Bandeja

cm. 13 x 7 5 1/9" x 2 3/4"

745



mm. 1,2 Vassoio petit four  
Petit-fours tray  
Plateau petit-fours  
Petit-Fours Tablett  
Porta dulces

cm. 26 10 1/4"

746



mm. 1,2 Vassoietto petit four  
Petit-fours tray  
Plateau petit-fours  
Petit-Fours Tablett  
Porta dulces

cm. 17,5 6 7/8"

742



Piattino per pasticceria H cm. 17,5 H 6 7/8"  
Petit-fours stand Ø cm. 14 Ø 5 1/2"  
Porte-petit fours  
Mokkaétagère  
Porta dulces  
mm. 1,2

990



PALACE  
Coppetta con vassoio  
Cup and tray  
Coupe avec plateau  
Schale mit Tablett  
Cuenco con bandeja  
mm. 1,2

H cm. 11,5 H 4 1/2"  
Ø cm. 10 Ø 3 7/8"

747



Cestino H cm. 11,5 H 4 1/2"  
Basket Ø cm. 10 Ø 3 7/8"  
Corbeille  
Früchtekorb  
Cesta  
mm. 1,2

990



738



746  
Vassoietto  
petit four

914  
Vassoietto  
Palace



737  
Vassoietto  
Giotto





# Fashion

403

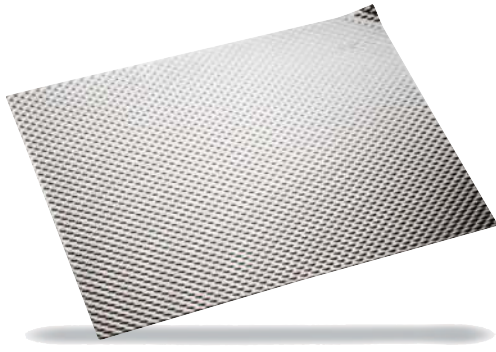

mm. 1,0  
Tovaglietta americana  
Place mat  
Set de table americain  
Tischset  
Individual en acero

cm. 41 x 31 16 2/5" x 12 1/4"

420

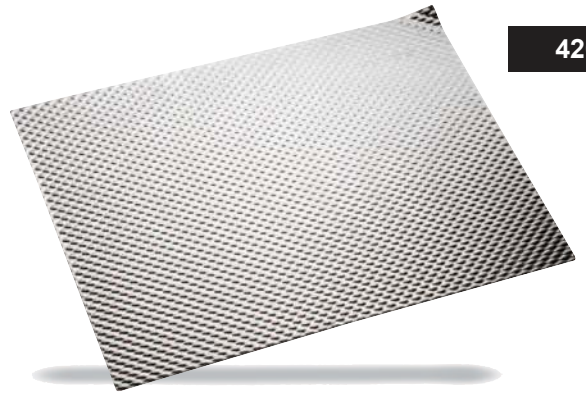

Vassoio gastronorm 1/1  
Tray gastronorm 1/1  
Plateau gastronorm 1/1  
Tablett, gastronorm 1/1  
Bandeja gastronorm 1/1

mm. 1,0 cm. 53 x 32,5 20 3/4" x 12 2/3"

416

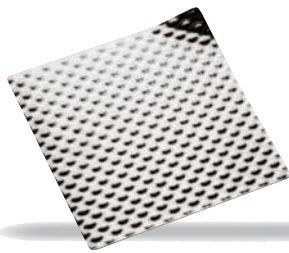

mm. 1,0 Vassoio finger food  
Finger food tray  
Plateau pour finger food  
Finger Food Tablett  
Bandeja por finger food

cm. 20 x 20  
7 7/8" x 7 7/8"

404

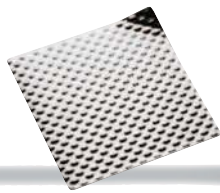

Portapane/Sottobottiglia  
Bread tray/Bottle coaster  
Brot Tablett/Flaschenteller  
Porte pan/Dessous de  
bouteille  
Portapan/Posabotella

cm. 12,5 x 12,5  
5" x 5"

426



mm. 1,0 Portastuzzicadenti  
Toothpick container  
Porte-cure-dents  
Zahnstocherbehälte  
Porta-palillos

cm. 11 x 3  
4 1/3" x 1 1/5"

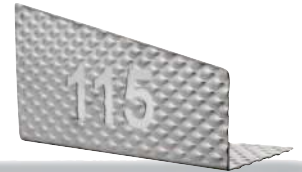

Numero da tavola  
Table number stand  
Numéro de table  
Tischnummer-Ständer  
Numero de mesa

cm. 15 x 8  
6" x 3 1/7"

422

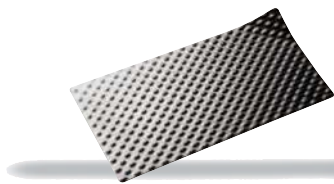

mm. 1,2 Vassoio amouse bouche  
Amouse bouche tray  
Plateau amouse bouche  
Amouse bouche Tablett  
Bandeja amouse bouche

cm. 20 x 10 7 7/8" x 4"

418

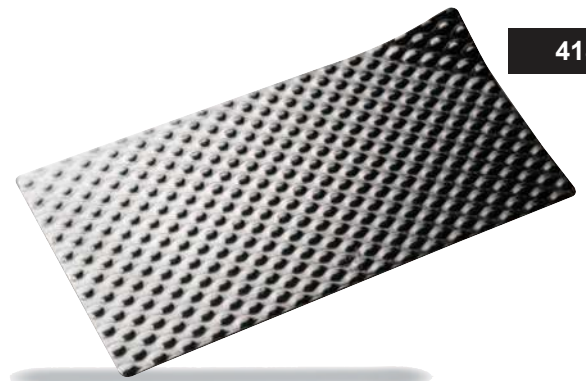

mm. 1,0 Vassoio gastronorm 2/4  
Tray gastronorm 2/4  
Plateau gastronorm 2/4  
Tablett, gastronorm 2/4  
Bandeja gastronorm 2/4

cm. 53 x 16,2 20 3/4" x 6 3/8"

417

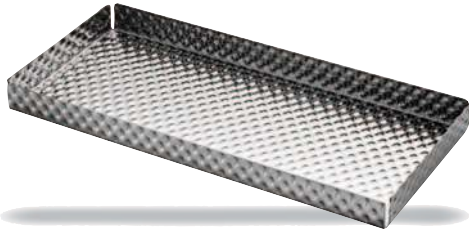

mm. 1,0 Cestino per pane e grissini cm. 26 x 12 10 1/4" x 4 3/4"  
 Bread/Bread sticks basket  
 Corbeille pour pan et gressin  
 Brot- und Grissinikorb  
 Cesta por pan y bastoncillos de pan

419



mm. 1,0 Vassoio gastronorm c/bordo cm. 53 x 32,5 20 3/4" x 12 2/3"  
 Tray gastronorm w/edges  
 Plateau gastronorm a/bords  
 Tablett, gastronorm m/Kanten  
 Bandeja gastronorm c/bordes

429

NEW



mm. 1,0 Vassoio per carrelli cm. 45 x 31 17 3/4" x 12 1/4"  
 Tray for rack trolley cm. 63 x 45 24 11/16" x 17 3/4"  
 Plateau pour chariot porte-plateau  
 Tablett für Rack  
 Bandeja para estante

NEW

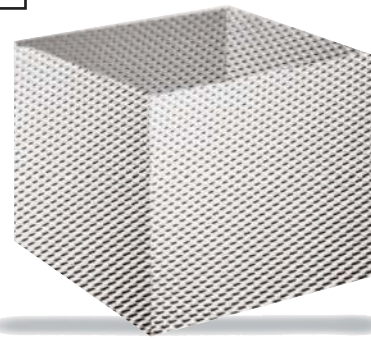

mm. 1,0 Secchiello per spumante H cm. 21 H 8 1/4"  
 Sparkling wine cooler cm. 21 x 21 8 1/4" x 8 1/4"  
 Seau à champagne lt. 9 gal. 2 1/2  
 Wein- und Sektkühler  
 Cubo para champany

430

427

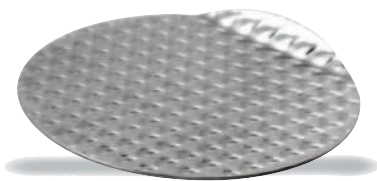

mm. 1,0 Sottobottiglia Ø cm. 10 Ø 4"  
 Bottle coaster  
 Dessous de bouteille  
 Flaschenteller  
 Posabotella

428

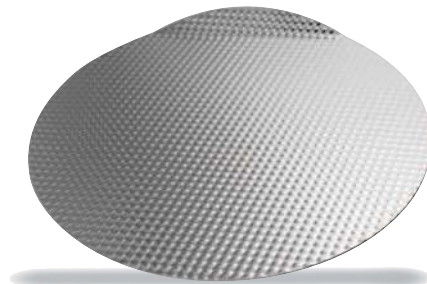

mm. 1,0 Sottopiatto Ø cm. 34 Ø 13 3/8"  
 Charger  
 Assiette de bienvenue  
 Platzteller  
 Bajo plato





# Buffet 4.0

212A



mm. 1,2 Centrotavola/Fruttiara cm. 38 x 32 15" x 9 7/8"  
Elevated centerpiece/Fruit-bowl H cm. 20 H 7 3/4"  
Centre de table/Compotier  
Tafelaufsatz/Obstschale  
Centro de mesa/Fruterero

222A



mm. 1,2 Centrotavola/Fruttiara cm. 46 x 31 18 1/4" x 12 1/4"  
Elevated centerpiece/Fruit-bowl H cm. 20 H 7 3/4"  
Centre de table/Compotier  
Tafelaufsatz/Obstschale  
Centro de mesa/Fruterero

212



mm. 1,2 Centrotavola/Fruttiara cm. 38 x 32 15" x 9 7/8"  
Elevated centerpiece/Fruit-bowl H cm. 13,2 H 5 1/5"  
Centre de table/Compotier  
Tafelaufsatz/Obstschale  
Centro de mesa/Fruterero

222



mm. 1,2 Centrotavola/Fruttiara cm. 46 x 31 18 1/4" x 12 1/4"  
Elevated centerpiece/Fruit-bowl H cm. 13,2 H 5 1/5"  
Centre de table/Compotier  
Tafelaufsatz/Obstschale  
Centro de mesa/Fruterero

561



mm. 1,2 Rettangolare piano cm. 23 x 13 9" x 5 1/8"  
Rectangular tray cm. 38 x 25 15" x 9 7/8"  
Plateau rectangulaire  
Tablett, rechteckig  
Bandeja rectangular

557



mm. 1,2 Ovale piano cm. 37 x 25 14 1/2" x 9 7/8"  
Oval tray cm. 46 x 31 18 1/4" x 12 1/4"  
Plateau, oval  
Tablett, oval  
Bandeja oval

Colori disponibili  
Available colors  
Couleurs disponibles  
Verfügbare Farben  
Colores disponibles



**O** Onice  
Onyx  
Onyx  
Onyx  
Onice



**N** Nero  
Black  
Noir  
Schwarz  
Negro



**W** Trasparente  
Transparent  
Glace  
Transparent  
Vidrio



**P** Porcellana  
White  
Porcelain  
Weiss  
Porcelana



Cereali



**265**  
Vassoio per pasticceria  
Patisserie tray  
Plateau pour patisserie  
Patisserie Tablett  
Bandeja para pasteleria

cm. 24,5 x 17  
cm. 30 x 21  
cm. 34 x 24

9 5/8" x 6 3/4"  
11 3/4" x 8 1/4"  
13 3/8" x 9 1/2"



**205**  
Vassoio per pasticceria c/pied.  
Patisserie tray with foot  
Plateau pour patisserie a/socle  
Patisserie Tablett mit Fuss  
Bandeja para pasteleria c/pies

cm. 26 x 12  
cm. 60 x 12  
H cm. 13

10 1/4" x 4 3/4"  
23 3/5" x 10 1/5"  
H 5 1/9"



**206**  
Vassoio per pasticceria  
Patisserie tray  
Plateau pour patisserie  
Patisserie Tablett  
Bandeja para pasteleria

cm. 26 x 12  
cm. 60 x 12

10 1/4" x 4 3/4"  
23 3/5" x 10 1/5"



**270**  
Portatovaglioli  
Napkin holder  
Distributeur de serviettes  
Serviettenhalter  
Portaservilletas

cm. 12,5 x 4,5  
H cm. 7

5" x 1 7/8"  
H 2 3/4"



**704**  
Portatovaglioli  
Napkin holder  
Distributeur de serviettes  
Serviettenhalter  
Portaservilletas

cm. 13 x 13

5 1/9" x 5 1/9"



**516**  
Portabustine da zucchero  
Sugar packet holder  
Pot à sucre  
Zuckerstangengefäß  
Azucarera

cm. 10 x 7  
H cm. 3

4" x 2 3/4"  
H 1 1/8"



**150**  
Piatto concavo  
Crescent plate  
Plateau concave  
Konkave Platte  
Plato concavo

Ø cm. 14      Ø 5 1/2"  
Ø cm. 18      Ø 7"  
Ø cm. 20      Ø 7 7/8"  
Ø cm. 22      Ø 8 5/8"  
Ø cm. 24      Ø 9 1/2"  
Ø cm. 26      Ø 10 1/4"  
Ø cm. 28      Ø 11"



**744**  
Cestino  
Basket  
Corbeille  
Früchtekorb  
Cesta

H cm. 11,5  
Ø cm. 10

H 4 1/2"  
Ø 3 7/8"



**870 - 871**  
GIOTTO  
Portapane / Portagrissini  
Bread / Bread sticks holder  
Porte pan / Porte gressin  
Brot und-Grissini -Schale  
Portapan / Porta bastoncillos de pan

**870**  
cm. 35,5 x 11  
14" x 4 1/3"

**871**  
cm. 24 x 11  
9 1/2" x 4 1/3"



**419**  
FASHION  
Vassoio gastronom c/bordo 1/1  
Tray gastronom w/edges 1/1  
Plateau gastronom a/bords 1/1  
Tablett, gastronom m/Kanten 1/1  
Bandeja gastronom c/bordes 1/1

cm. 53 x 32,5

20 3/4" x 12 2/3"

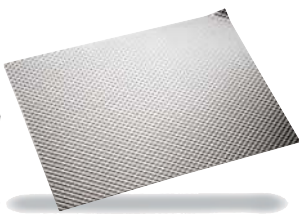

**420**  
FASHION  
Vassoio gastronom 1/1  
Tray gastronom 1/1  
Plateau gastronom 1/1  
Tablett, gastronom 1/1  
Bandeja gastronom 1/1

cm. 53 x 32,5

20 3/4" x 12 2/3"

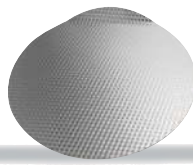

**428**  
FASHION  
Sottopiatto  
Charger  
Assiette de bienvenue  
Platzteller  
Bajo plato

Ø cm. 34

Ø 13 3/8"



**403**  
FASHION  
Tovaglietta americana  
Place mat  
Set de table americain  
Tischset  
Individual en acero

cm. 41 x 31

12 1/4" x 16 2/5"

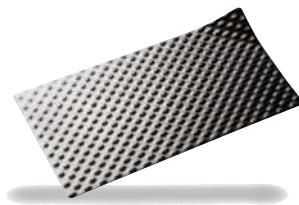

**418**  
FASHION  
Vassoio gastronom 2/4  
Tray gastronom 2/4  
Plateau gastronom 2/4  
Tablett, gastronom 2/4  
Bandeja gastronom 2/4

cm. 53 x 16,2

20 3/4" x 6 3/8"

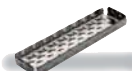
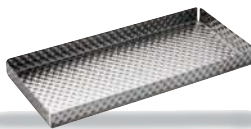
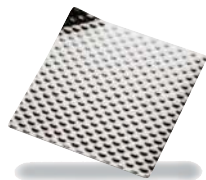
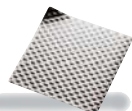
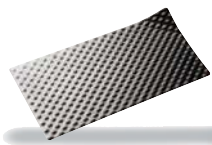

**422**  
FASHION  
Vassoio amouse buche  
Amouse buche tray  
Plateau amouse buche  
Amouse buche Tablett  
Bandeja amouse buche

cm. 20 x 10

7 7/8" x 4"

**404**  
FASHION  
Portapan/Sottobottiglia  
Bread tray/Bottle coaster  
Porte pan/Dessous de  
bouteille  
Brot Tablett/Flaschenteller  
Portapan/Posabotella

cm. 12,5 x 12,5

5" x 5"

**416**  
FASHION  
Vassoio finger food  
Finger food tray  
Plateau pour finger food  
Finger Food Tablett  
Bandeja por finger food

cm. 20 x 20

7 7/8" x 7 7/8"

**417**  
FASHION  
Cestino per pane e grissini  
Bread/Bread sticks basket  
Corbeille pour pan et grissini  
Brot- und Grissinikorb  
Cesta por pan y bastoncillos  
de pan

cm. 26 x 12

10 1/4" x 4 3/4"

**427**  
FASHION  
Sottobottiglia  
Bottle coaster  
Dess.de bouteille  
Flaschenteller  
Posabotella

Ø cm. 10

Ø 4"

**423**  
FASHION  
Portastuzzicadenti/Appoggiaposate  
Toothpick container/Knife rest  
Porte-cure-dents/Soutier p/couverts  
Zahnstocherbehälter/Messer bank  
Porta-palillos/Apoyo p/cubiertos

cm. 11 x 3

4 1/3" x 1 1/5"



**391**  
H cm. 13  
H 5 1/9"

**387**  
H cm. 10  
H 4"

**382**  
H cm. 7,5  
H 3"

**383**  
H cm. 5,5  
H 2 1/6"

Basi  
Risers  
Stands de buffet  
Buffetständer  
Soportes de buffet



**390**  
H cm. 6  
H 2 1/3"



**388**  
H cm. 7,4  
H 2 7/8"



**389**  
H cm. 14  
H 5 1/2"



**386**  
H cm. 7,5  
H 3"



**385**  
H cm. 3,0  
H 1 1/4"



**384**  
H cm. 8,5  
H 3 3/8"



# Buffet

682



TU0687G

mm. 0,8

Caraffa per bibite  
Jug for drinks w/ice container  
Carafe avec compartiment glaçons  
Saftkrug mit Kühleinsatz  
Jarra agua

lt. 2,5 84 1/2 oz.

691



TU0692V

mm. 0,8

Infusiera con contenitore trasparente  
Infuser jug  
Carafe d'eau avec infuseur  
Wasserkrug mit Infuser  
Jarra de agua de infusión

lt. 2,5 84 1/2 oz.

68702



TU0687G

mm. 0,8

AURORA  
Caraffa per bibite  
Jug for drinks w/ice container  
Carafe avec compartiment glaçons  
Saftkrug mit Kühleinsatz  
Jarra agua

lt. 2 67 3/4 oz.

69202



TU0692V

mm. 0,8

AURORA  
Infusiera con contenitore trasparente  
Infuser jug  
Carafe d'eau avec infuseur  
Wasserkrug mit Infuser  
Jarra de agua de infusión

lt. 2 67 3/4 oz.

# BUFFET

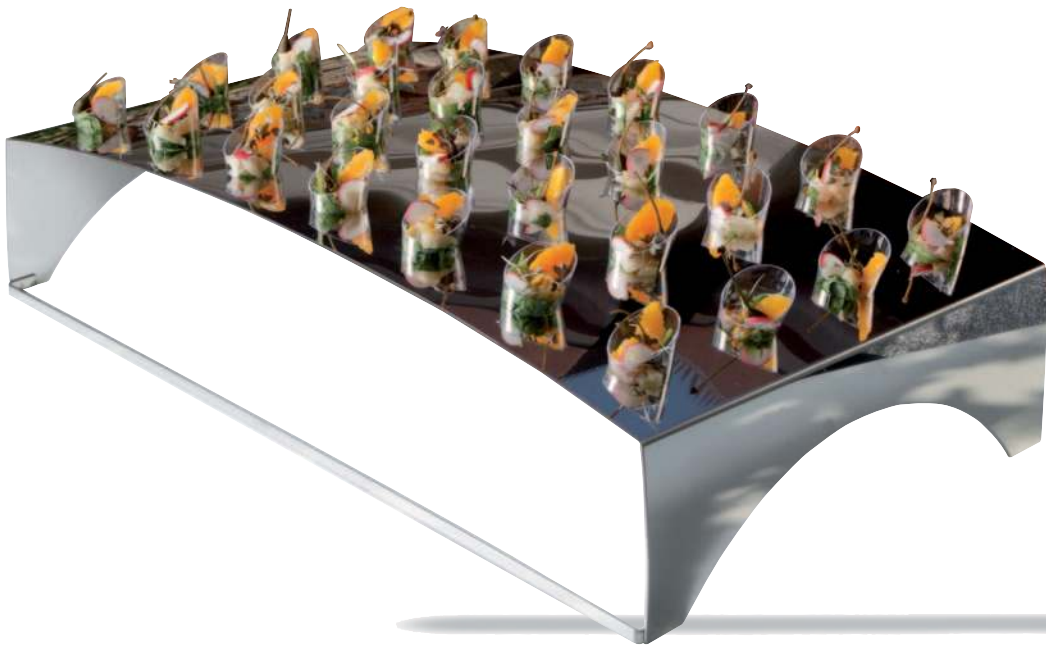



549

537



mm. 1,2 Centrotavola  
Tray 14 compartments  
Plateau 14 pièces  
Tablett 14 Einsätze  
Bandeja 14 posiciones

53706



mm. 1,2 Mini vassoi per finger food  
Mini trays for finger food  
Mini plateau pour finger food  
Mini Tablett für finger food  
Mini bandejas por finger food

53712



cm. 12 x 12 4 3/4" x 4 3/4"  
cm. 15 x 15 5 7/8" x 5 7/8"

cm. 45 x 28 17 3/4" x 11 1/8"

7011

7011E



cl. 9 - oz. 3

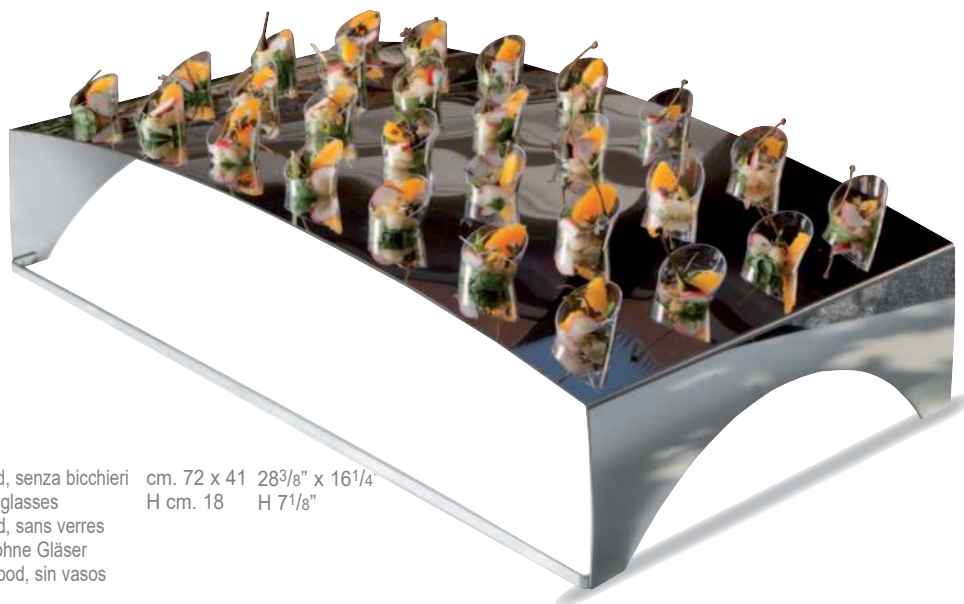

mm. 1,2 Espositore buffet per finger food, senza bicchieri  
Buffet set for finger food, w/out glasses  
Service à buffet pour finger food, sans verres  
Buffet Display für Finger food, ohne Gläser  
Servicio para buffet por finger food, sin vasos

cm. 72 x 41 28 3/8" x 16 1/4"  
H cm. 18 H 7 1/8"

563

560



mm. 1,2 Quadro piano  
Square tray  
Plateau carré  
Tablett, quadratisch  
Bandeja cuadrada

cm. 15 x 15 5 7/8" x 5 7/8"  
cm. 22 x 22 8 5/8" x 8 5/8"



mm. 1,2 Tondo fondo  
Round bowl  
Bol ronde  
Obstschale, rund  
Cuenco redondo

Ø cm. 12 cl. 26 Ø 4 3/4" oz. 8 3/4  
Ø cm. 15 cl. 60 Ø 5 7/8" oz. 20 1/4  
Ø cm. 22 cl. 131 Ø 8 5/8" oz. 44 1/3  
Ø cm. 32 lt. 3,0 Ø 12 5/8" oz. 101 2/5

# BUFFET



# BUFFET





# BUFFET

591P



Bicchiere  
Glass  
Gobelet  
Glas  
Vaso

H cm 13 H 5"  
cl. 45 oz 15 1/4

588P



Bicchiere  
Glass  
Gobelet  
Glas  
Vaso

H cm 10 H 3 7/8"  
cl. 33 oz. 11 1/8

1131



Mini Forchetta  
Appetizer fork  
Fourchette amouse  
bouche  
Minigabel  
Mini tenedor

cm. 11,4 4 1/2"

Mini spoon cm. 11,4 4 1/2"

7012



Vassoio per canapè con bicchieri  
Canape tray with glasses  
Plateau à canape avec verres  
Buffet Display mit Gläser  
Bandeja para canapé con vasos

8 pz. 8 pcs  
cm. 42 x 42 16 1/2" x 16 1/2"  
17 pz. 17 pcs  
cm. 42 x 72,5 16 1/2" x 28 1/2"

543N



Bicchiere per champagne  
Champagne glass  
Verre pour Champagne  
Champagnerglas  
Vaso por champán

H cm. 22,7 H 9"  
cl. 15 oz. 5 1/8

555N



Piano per buffet  
Tray for buffet  
Plateau pour buffet  
Buffettablett  
Bandeja para buffet

Ø cm. 18 Ø 10 1/2"

543

**A** Ambra  
Amber  
Ambre  
Amber  
Ambar



**G** Granato  
Garnet  
Grenat  
Granat  
Granate



**S** Smeraldo  
Emerald  
Emeraude  
Smaragd  
Esmeralda



**Z** Zaffiro  
Sapphyre  
Saphir  
Saphir  
Zafiro



**M** Ametista  
Amethyst  
Amethyste  
Amethyst  
Amatista



**W** Trasparente  
Transparent  
Glace  
Transparent  
Vidrio



**O** Onice  
Onyx  
Onyx  
Onyx  
Onice



**P** Porcellana  
White  
Porcelain  
Weiss  
Porcelana



**N** Nero  
Black  
Noir  
Schwarz  
Negro



# BUFFET

7199



PALACE  
Chafing Dish rettangolare con coperchio girevole a 180°  
Rectangular Chafing Dish with 180° revolving cover  
Chafing Dish rectangulaire avec couvercle basculant à 180°  
Chafing Dish rechteckig mit 180° Rollhaube  
Chafing Dish rectangular con tapa volvible à 180°

cm. 66 x 45  
H cm. 43  
Lt. 6,5

26" x 17 3/4"  
H 17"  
gal. 1 3/4

7199A



cm. 52 x 32  
20 1/2" x 12 3/4"

PALACE  
Zuppiera per art. 7199  
Soup station for art. 7199  
Marmite à potage pour art. 7199  
Suppenstation für Art. 7199  
Sopera para art. 7199

Ø cm. 21,5 Ø 8 1/2"

7201



PALACE  
Chafing Dish tondo con coperchio girevole a 180°  
Round Chafing Dish with 180° revolving cover  
Chafing Dish rond avec couvercle basculant à 180°  
Chafing Dish rund mit 180° Rollhaube  
Chafing Dish rendono con tapa volvible à 180°

Ø cm. 40  
H cm. 46  
Lt. 4,5

Ø 15 3/4"  
H 18 1/8"  
gal. 1 1/4

Ø cm. 38,5 esterno  
Ø cm. 22 interno

Ø 15 1/8" outside  
Ø 8 3/4" inside



7201A

PALACE  
Zuppiera per art. 7201  
Soup station for art. 7201  
Marmite à potage pour art. 7201  
Suppenstation für Art. 7201  
Sopera para art. 7201

Ø cm. 21,5 Ø 8 1/2"

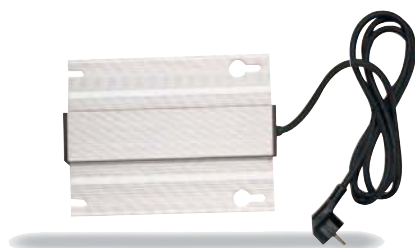

Piastra elettrica per art. 7199  
Electric Heater for art. 7199  
Element de chauffage électrique pour art. 7199  
Heizelement für Art. 7199  
Calientador eléctrico para art. 7199

7199B 110V  
7199C 220V

cm. 25 x 19  
9 3/4" x 7 1/2"

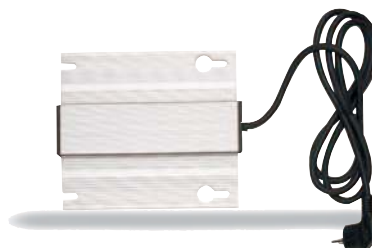

Piastra elettrica per art. 7201  
Electric Heater for art. 7201  
Element de chauffage électrique pour art. 7201  
Heizelement für Art. 7201  
Calientador eléctrico para art. 7201

7201B 110V  
7201C 220V

cm. 21,5 x 18,5  
8 1/2" x 7 1/4"

151



mm. 1,2 Vassoio rettangolare  
Rectangular tray  
Plateau de presentation  
Tablett, rechteckig  
Bandeja rectangular

cm. 63 x 45  
24 11/16" x 17 3/4"

7204



Coffee Urn	PALACE	Ø cm. 32	gal. 2 <sup>3</sup> / <sub>4</sub>
Coffee Urn	"	H cm. 60	H 23 <sup>5</sup> / <sub>8</sub> "
Bouilleur	"	lt. 11	Ø 12 <sup>5</sup> / <sub>8</sub> "
Kaffeespender	"	Ø cm. 32	Ø 12 <sup>5</sup> / <sub>8</sub> "
Contenedor para café	"	H cm. 67	H 26 <sup>3</sup> / <sub>8</sub> "
		lt. 19	gal. 5

7206



Distributore per succo di frutta	PALACE	cm. 26 x 35	10 1/4" x 13 3/4"
Juice dispenser	"	H cm. 58	H 22 7/8"
Distributeur à jus	"	lt. 7	gal. 1 7/8
Saftdispenser	"		
Contenedor para zumo de fruta	"		

7208



Doppio distributore per succo di frutta	PALACE	cm. 56 x 35
Double Juice dispenser	"	H cm. 58
Double distributeur à jus	"	lt. 14
Doppel Saftdispenser	"	22" x 13 3/4"
Doble contenidor para zumo de fruta	"	H 22 7/8"
		gal. 3 1/2

HAPPY

10001175



Nuovo sistema per il servizio delle pietanze, per evitare la caduta delle posate all'interno degli chafing. Tutta la collezione HAPPY è a pag. 98.

A new collection of serving pieces designed with a handle that securely rests on the edge of the chafing dish when not in use. The entire Happy collection can be found on page 98.

Nouveau système pour le service des plats, pour éviter la chute des couverts à l'intérieur des chafing. Toute la collection HAPPY est au pag. 98.

"HAPPY" ist eine neue platzsparende Idee, wie man von Chafing Dishes Speisen auf Teller füllen kann, ohne dass die Servierteile hineinfallen. Gesamte HAPPY Kollektion auf Seite 98.

Nuevo sistema por el servicio de las comidas, para evitar la caída de los cubiertos dentro de los chafing. Toda la colección HAPPY es a pag. 98.

Apoggia posate  
Knife rest  
Soutier p/couverts  
Messer bank  
Apoyo p/cubiertos

Largh. cm 6,5  
Width 2 1/2"

# BUFFET

7087



Chafing Dish 1/1 rettangolare con coperchio amovibile cm. 61 x 30 24" x 11 3/4"  
 Rectangular Chafing Dish 1/1 with removable cover H cm. 32,5 H 12 3/4"  
 Chafing Dish 1/1 rectangulaire avec couvercle démontable lt. 6,5 gal. 1 3/4  
 Chafing Dish 1/1 rechteckig mit abnehmbarer Haube  
 Chafing Dish 1/1 rectangular con tapa amovible

7086



GIOTTO  
 Chafing Dish 1/1 rettangolare con coperchio amovibile cm. 61 x 30  
 Rectangular Chafing Dish 1/1 with removable cover H cm. 32,5  
 Chafing Dish 1/1 rectangulaire avec couvercle démontable lt. 6,5  
 Chafing Dish 1/1 rechteckig mit abnehmbarer Haube 24" x 11 3/4"  
 Chafing Dish 1/1 rectangular con tapa amovible H 12 3/4"  
 gal. 1 3/4

7090



mm. 0,8 Rinfrescatore per yogurt cm. 52,5 x 32,5 20 5/8" x 12 3/4"  
 Yogurt cooler lt. 8 gal. 2  
 Rafrachisseur à yaourts  
 Yoghurtkühler  
 Refrigerador para yogurt

236



mm. 1,2 Rinfrescatore per yogurt Ø cm.38  
 Yogurt cooler H cm. 9  
 Rafrachisseur à yaourts lt. 3,0 Ø 15"  
 Yoghurtkühler oz. 101 2/5  
 Refrigerador para yogurt

## BUFFET

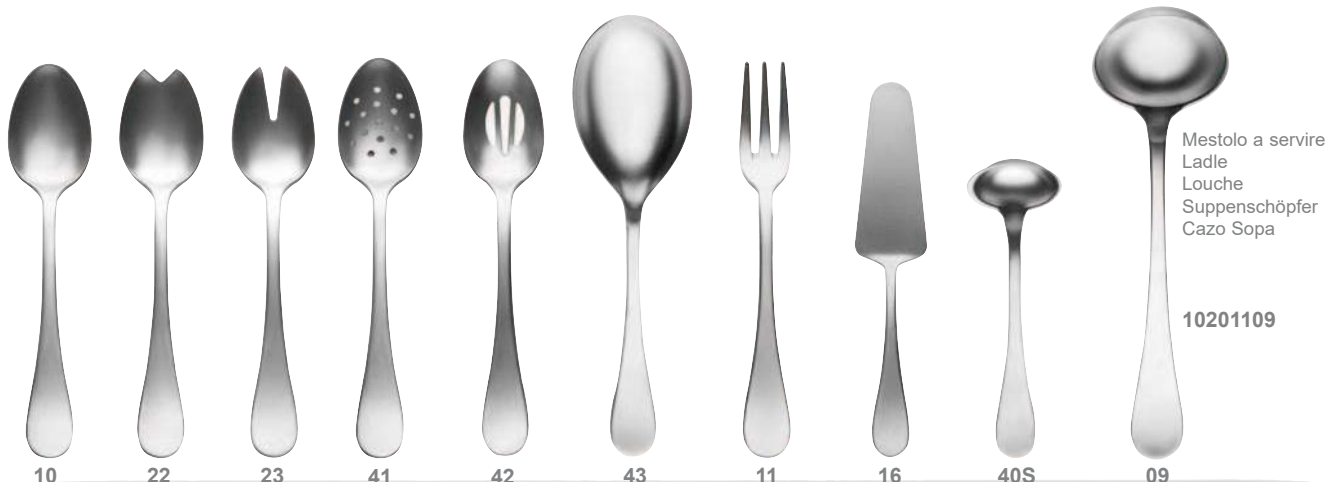

10

22

23

41

42

43

11

16

40S

09

Cucchiaione  
 Cooking spoon  
 Cuillère à légumes/  
 à ragût  
 Gemüselöffel  
 Cuchara legumbres

Cucchiaio nsalata  
 Salad serving  
 spoon  
 Cuillère à salade  
 servir  
 Salatvorlegelöffel  
 Cuchara servir  
 ensalada

Forchetta Insalata  
 Salad serving fork  
 Fourchette  
 à salade servir  
 Salatvorlegegabel  
 Tenedor servir  
 ensalada

Cucchiaione  
 con fori  
 Serving spoon  
 w/holes  
 Cuillère a/trous  
 Servierlöffel  
 m/Löchern  
 Cuchara  
 c/agujeros

10201141

Cucchiaione  
 con asole  
 Serving spoon  
 w/slots  
 Cuillère a/oieilles  
 Servierlöffel  
 m/Ösen  
 Cuchara  
 c/ojales

10201142

Cucchiaio risotto  
 "Risotto" spoon  
 Cuillère "Risotto"  
 Reislöffel  
 Cuchara arroz seco

10201143

Forchettone a servire  
 Serving fork  
 Fourchette à légumes/  
 à servir  
 Fleischgabel  
 Tenedor legumbres

10201111

Pala per Torta  
 Cake trowel  
 Pelle à tarte  
 Tortenheber  
 Pala tarta

10201116

Mestolo a servire  
 Ladle  
 Louche  
 Suppenschöpfer  
 Cazo Sopa

10201109

Mestolino per Salsa  
 Gravy ladle  
 Cuillère à sauce  
 Saucenöffel  
 Cacillo para salsa

10201140S

10201110

224

7999

7999



"MATHUSALEM"  
lt. 6 - gal. 1 1/2

"SALMANAZAR"  
lt. 9 - gal. 2 1/2

Culla portachampagne "MATHUSALEM" lt. 6 - gal. 1 1/2  
 Champagne holder "SALMANAZAR" lt. 9 - gal. 2 1/2  
 Porte-champagne  
 Champagnerflaschenhalter cm 45 x 31 - H cm 65  
 Portabotella de champagne 17 3/4" x 12 1/4" - H 25 1/2"





Yogurt



Miele



# Palace

964



mm. 1,2 Vassoio rettangolare con maniglie  
Rectangular Tray with handles  
Plateau rectangulaire avec anses  
Tablett rechteckig mit Griffen  
Bandeja rectangular con asas

cm. 40x27	15 <sup>3</sup> / <sub>4</sub> " x 10 <sup>5</sup> / <sub>8</sub> "
cm. 45x31	17 <sup>3</sup> / <sub>4</sub> " x 12 <sup>1</sup> / <sub>4</sub> "
cm. 50x34	19 <sup>5</sup> / <sub>8</sub> " x 13 <sup>3</sup> / <sub>8</sub> "
cm. 60x42	23 <sup>5</sup> / <sub>8</sub> " x 16 <sup>1</sup> / <sub>8</sub> "

963GN



mm. 1,2 Vassoio rettangolare gastronomico  
Rectangular gastronomic Tray  
Plateau rectangulaire gastronomico  
Tablett rechteckig gastronomico  
Bandeja rectangular gastronomico

cm. 53 x 32,5	20 <sup>3</sup> / <sub>4</sub> " x 12 <sup>2</sup> / <sub>3</sub> "
---------------	---

963



mm. 1,2 Vassoio rettangolare  
Rectangular Tray  
Plateau rectangulaire  
Tablett rechteckig  
Bandeja rectangular

cm. 30x21	11 <sup>3</sup> / <sub>4</sub> " x 8 <sup>1</sup> / <sub>4</sub> "
cm. 35x24	13 <sup>3</sup> / <sub>4</sub> " x 9 <sup>1</sup> / <sub>2</sub> "
cm. 40x27	15 <sup>3</sup> / <sub>4</sub> " x 10 <sup>5</sup> / <sub>8</sub> "
cm. 45x31	17 <sup>3</sup> / <sub>4</sub> " x 12 <sup>1</sup> / <sub>4</sub> "
cm. 50x34	19 <sup>5</sup> / <sub>8</sub> " x 13 <sup>3</sup> / <sub>8</sub> "
cm. 60x42	23 <sup>5</sup> / <sub>8</sub> " x 16 <sup>1</sup> / <sub>8</sub> "

966



mm. 1,2 Vassoio tondo  
Round Tray  
Plateau rond  
Tablett rund  
Bandeja redonda

Ø cm. 13	Ø 5 1/8"
Ø cm. 19	Ø 7 1/2"
Ø cm. 24	Ø 9 1/2"
Ø cm. 27	Ø 10 5/8"
Ø cm. 35	Ø 13 3/4"
Ø cm. 40	Ø 15 3/4"

965



mm. 1,2 Vassoio rettangolare con piedini  
Rectangular Tray with feet  
Plateau rectangulaire avec socles  
Tablett rechteckig mit Füßen  
Bandeja rectangular con 4 pies

cm. 30x21	11 <sup>3</sup> / <sub>4</sub> " x 8 <sup>1</sup> / <sub>4</sub> "
cm. 35x24	13 <sup>3</sup> / <sub>4</sub> " x 9 <sup>1</sup> / <sub>2</sub> "
cm. 40x27	15 <sup>3</sup> / <sub>4</sub> " x 10 <sup>5</sup> / <sub>8</sub> "
cm. 45x31	17 <sup>3</sup> / <sub>4</sub> " x 12 <sup>1</sup> / <sub>4</sub> "
cm. 50x34	19 <sup>5</sup> / <sub>8</sub> " x 13 <sup>3</sup> / <sub>8</sub> "
cm. 60x42	23 <sup>5</sup> / <sub>8</sub> " x 16 <sup>1</sup> / <sub>8</sub> "

967



mm. 1,2 Vassoio tondo con piedini  
Round Tray with feet  
Plateau rond avec socles  
Tablett rund mit Füßen  
Bandeja redonda con 4 pies

Ø cm. 27	Ø 10 5/8"
Ø cm. 35	Ø 13 3/4"
Ø cm. 40	Ø 15 3/4"

950



mm. 1,2	Ciotola con base	Ø cm. 14	cl. 60	Ø 5 1/2"	oz. 20 1/4
	Bowl with base	H cm. 8,8		H 3 1/2"	
	Bol avec socle	Ø cm. 20	lt. 1,8	Ø 7 7/8"	oz. 60 7/8
	Obstschale auf Fuss	H cm. 11		H 4 1/2"	
	Cuenco con pedestal	Ø cm. 24	lt. 3,1	Ø 9 1/2"	oz. 104 7/8
		H cm. 14		H 5 1/2"	
		Ø cm. 28	lt. 5,1	Ø 11"	gal. 1 1/4
		H cm 16		H 6 1/3"	

977



mm. 1,2	Porta pasticcini	Ø cm 13	Ø 5 1/8"
	Petit-fours stand	H cm 10,5	H 4 1/8"
	Porte-petit fours		
	Petits Fours-Ständer	Ø cm 19	Ø 7 1/2"
	Porta dulces	H cm 14	H 5 1/2"

981A



mm. 1,2	Alzata portafrutta rettang. 2 piani	cm 35x24	13 3/4" x 9 1/2"
	Rectangular fruit holder 2 layers	cm 45x31	17 3/4" x 12 1/4"
	Serviteur rectangulaire 2 etages	H cm 50	H 19 5/8"
	Etagere, rechteckig 2-stufig		
	Frutero rectangular 2 pisos		

981B



mm. 1,2	Alzata portafrutta rettang. 3 piani	cm 35x24	13 3/4" x 9 1/2"
	Rectangular fruit holder 3 layers	cm 45x31	17 3/4" x 12 1/4"
	Serviteur rectangulaire 3 etages	cm 60x42	25 5/8" x 16 1/8"
	Etagere, rechteckig 3-stufig	H cm 73	H 28 3/4"
	Frutero rectangular 3 pisos		

978



mm. 1,2 Porta pasticcini a 2 piani  
Petit-fours stand 2 layers  
Porte-petit fours 2 etages  
Mokkaétagère 2 Ebenen  
Porta dulces 2 pisos

Ø cm. 13	Ø 5 1/8"
Ø cm. 19	Ø 7 1/2"
H cm. 29	H 11 3/8"

97803



mm. 1,2 Porta pasticcini a 3 piani  
Petit-fours stand 3 layers  
Porte-petit fours 3 etages  
Mokkaétagère 3 Ebenen  
Porta dulces 3 pisos

Ø cm 13	Ø 5 1/8"
Ø cm 19	Ø 7 1/2"
Ø cm 27	Ø 10 3/8"
H cm 36	H 14 1/4"

980B



mm. 1,2 Alzata portafrutta tonda 3 piani  
Round fruit holder 3 layers  
Serviteur rond 3 etages  
Etager, rund 3-stufig  
Frutero redondo 3 pisos

Ø cm 27	Ø 10 5/8"
Ø cm 35	Ø 13 3/4"
Ø cm 40	Ø 15 3/4"
H cm 73	H 28 3/4"

980A



mm. 1,2 Alzata portafrutta tonda 2 piani  
Round fruit holder 2 layers  
Serviteur rond 2 etages  
Etager, rund 2-stufig  
Frutero redondo 2 pisos

Ø cm 27	Ø 10 5/8"
Ø cm 35	Ø 13 3/4"
H cm 50	H 19 5/8"

928



mm. 1,2 Vassoio rettangolare da servizio  
 Rectangular service tray  
 Plateau rectangulaire pour service  
 Tablett rechteckig für Service  
 Bandeja rectangular da servicio

cm. 30x21	11 <sup>3</sup> / <sub>4</sub> " x 8 <sup>1</sup> / <sub>4</sub> "
cm. 35x24	13 <sup>3</sup> / <sub>4</sub> " x 9 <sup>1</sup> / <sub>2</sub> "
cm. 40x27	15 <sup>3</sup> / <sub>4</sub> " x 10 <sup>5</sup> / <sub>8</sub> "
cm. 45x31	17 <sup>3</sup> / <sub>4</sub> " x 12 <sup>1</sup> / <sub>4</sub> "
cm. 50x34	19 <sup>5</sup> / <sub>8</sub> " x 13 <sup>3</sup> / <sub>8</sub> "
cm. 60x42	23 <sup>5</sup> / <sub>8</sub> " x 16 <sup>1</sup> / <sub>8</sub> "

927



mm. 1,2 Vassoio tondo da servizio  
 Round service tray  
 Plateau rond pour service  
 Tablett rund für Service  
 Bandeja redonda por servicio

Ø cm. 27	Ø 10 <sup>5</sup> / <sub>8</sub> "
Ø cm. 35	Ø 13 <sup>3</sup> / <sub>4</sub> "
Ø cm. 40	Ø 15 <sup>3</sup> / <sub>4</sub> "

959



Coppa in vetro c/piedistallo  
 Glass bowl with base  
 Coupe ronde en verre a/socle  
 Glassobstschale rund auf Fuß  
 Cuenco redondo en vidrio c/pedestal

**959**  
 Ø cm 21,5  
 H cm 29  
 cl. 270

**960**  
 Ø cm 12  
 H cm 17  
 cl. 45

960



982



Piatto da torta in vetro c/piedistallo  
 Glass cake plate with base  
 Plat pour gateau en verre a/socle  
 Kuchenplatte aus Glas auf Fuss  
 Plato para tarta en vidrio c/pedestal

Ø cm 33  
 H cm 16  
 Ø 12<sup>3</sup>/<sub>4</sub>"  
 H 6<sup>1</sup>/<sub>4</sub>"

958



Coppa multiservizio  
 Glass bowl with sauce cap  
 Coupe multifonctions  
 Universalschale  
 Ensaladera multiservicio

Ø cm 28  
 H cm. 14  
 cl. 300  
 Ø 11"  
 H 5<sup>1</sup>/<sub>2</sub>"  
 oz. 101<sup>1</sup>/<sub>2</sub>

938



mm. 1,2 Vassoio ovale  
 Oval tray  
 Plateau oval  
 Tablett oval  
 Bandeja oval

cm. 31 x 22 12<sup>1</sup>/<sub>8</sub>" x 8<sup>3</sup>/<sub>4</sub>"

937



mm. 1,2 Cestino per pane  
 Oval basket  
 Corbeille oval  
 Brotkorb oval  
 Frutero oval

cm. 31 x 22 12<sup>1</sup>/<sub>8</sub>" x 8<sup>3</sup>/<sub>4</sub>"  
 lt. 1,7 oz. 57<sup>1</sup>/<sub>2</sub>

968



mm. 2,0 Ampolla e formaggera  
Cruet and cheese basin  
Huillière et fromagère  
Essig-Ölflasche und Käsedose  
Vinagrera y quesera

cl. 22 H cm 15  
oz. 7 1/2 H 5 7/8"

cl. 20  
oz. 6 3/4

969



mm. 2,0 Salino e porta stuzzicadenti  
Salt-cellar and toothpick container  
Salière et porte cure-dents  
Salzstreuer und Zahnstocherbehälter  
Salero y palillero

cl. 8 H cm. 9  
oz. 2 3/4 H 3 1/2"

cl. 7 H cm 7  
oz. 2 3/8 H 2 3/4"

975



mm. 1,2 Chillcup  
Caviar dish  
Bol à caviar  
Chillcup / Kaviarschale  
Bol para caviar

cl. 15 H cm 19  
oz. 5 1/8  
Ø 7 1/2"

976



mm. 1,2 Servizio per antipasto  
Snack server  
Support à snacks  
Relish-Pickles-Gestell  
Entremesera

Ø cm. 20 H cm 15  
cl. 15 (x3)

Ø 7 7/8" H 5 7/8"  
oz. 5 1/8 (x3)

935



mm. 1,2 Porta macaron  
Macarons server  
Porte macarons  
Macaronsträger  
Porta macaron

Ø cm 15 H cm 10  
Ø 5 7/8" H 4"

976S



mm. 1,2 Portasalatini impilabile  
Stackable snack server  
Support à snack empilable  
Stapelbare Relish-Pickles-Gestell  
Servicio por entremes impilable

Ø cm. 20 H cm 15  
cl. 15 (x3)

Ø 7 7/8" H 5 7/8"  
oz. 5 1/8 (x3)

**976C**  
Ø cm. 20 H cm 15  
cl. 15 (x3)

**976C**  
Ø 7 7/8" H 5 7/8"  
oz. 5 1/8 (x3)

951



mm. 1,2 Caffettiera con piedistallo  
Coffee pot with base  
Cafetière avec socle  
Kaffekanne auf Fuss  
Cafetera con pedestal

Tazze	4	cl 34	oz 12 <sup>1</sup> / <sub>3</sub>
Cups	6	cl 52	oz 17 <sup>2</sup> / <sub>3</sub>
Bols			
Tassen			
Tazas			

952



mm. 1,2 Teiera con piedistallo  
Tea pot with base  
Théière avec socle  
Teekanne auf Fuss  
Tetera con pedestal

Tazze	2	cl 37	oz 13
Cups	6	cl 60	oz 21
Bols			
Tassen			
Tazas			

953



mm. 1,2 Lattiera con piedistallo  
Milk jug with base  
Pot à lait avec socle  
Milchkanne auf Fuss  
Jarra lechera con pedestal

Tazze	2	cl 24	oz 8
Cups	4	cl 34	oz 12 <sup>1</sup> / <sub>3</sub>
Bols			
Tassen			
Tazas			

954



mm. 1,2 Zuccheriera con piedistallo  
Sugar bowl with base  
Sucrier avec socle  
Zuckerdose auf Fuss  
Azucarero con pedestal

Tazze	6	cl 27	oz 10
Cups			
Bols			
Tassen			
Tazas			

957



mm. 1,2 Portabustine da zucchero  
Sugar packet holder  
Pot à sucre  
Zuckerstangengefäß  
Azucarera

Ø cm 7	H cm 9,5
Ø 2 <sup>3</sup> / <sub>4</sub> "	H 3 <sup>3</sup> / <sub>4</sub> "

914

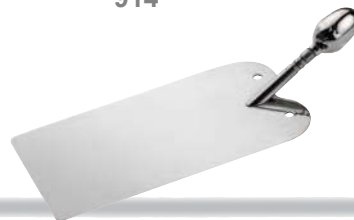

mm. 1,2 Vassoietto  
Tray  
Plateau  
Tablett  
Bandeja

cm. 13 x 7  
5 <sup>1</sup>/<sub>9</sub>" x 2 <sup>3</sup>/<sub>4</sub>"

982



mm. 1,2 Alzata portafrutta  
Fruit holder  
Serviteur  
Obstschale  
Frutero

Ø cm 27	H cm. 15
Ø 10 <sup>5</sup> / <sub>8</sub> "	H 5 <sup>7</sup> / <sub>8</sub> "

247

247



Ø cm*	Ø in*
7,5	3"
10	4"
10,5	4 1/16"
13	5 1/16"
13,2	5 1/5"
14	5 1/2"
14,5	5 5/7"
20	7 7/8"
22	8 5/8"
24	9 1/2"
26	10 1/4"
28	11"
30	11 3/4"
31	12 1/8"
32	12 5/8"
33	13"

mm. 0,8 Cloche con pomolo  
Cloche with knob  
Cloche  
Teller cloche  
Tapa con pomo

\* Tabella diametri misurati al bordo del piatto  
\* Table of diameters, measured at the edge of the plate

984

974

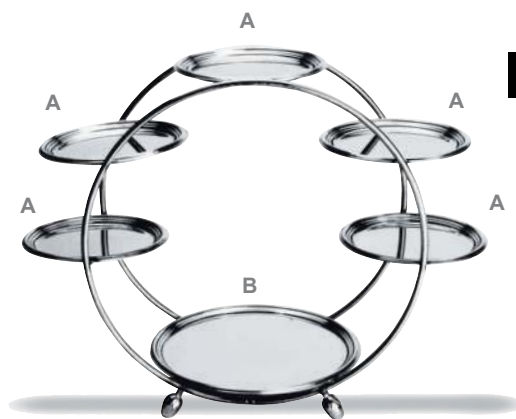
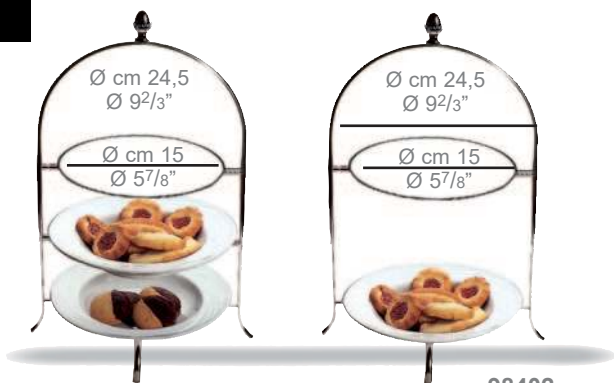

	<b>984</b>	<b>984</b>	<b>98402</b>	
Alzata portapiatti	Ø cm 24	Ø 9 1/2"	Ø cm 24	Ø 9 1/2"
Afternoon tea stand	H cm.43	H 16 7/8"	H cm.43	H 16 7/8"
Présentoir à gateau	<b>985</b>	<b>985</b>		
Dessert-Serviergestell	Ø cm 21	Ø 8 1/4"		
Soporte platos	H cm.37	H 14 1/2"		
	<b>989</b>	<b>989</b>		
	Ø cm 30	Ø 11 3/4"		
	H cm.50,5	H 19 7/8"		

mm. 1,2 Présentoir  
2 misure  
2 sizes  
2 tailles  
2 Größen  
2 tamaños

<b>A</b> Ø cm.13 (x5)	<b>A</b> Ø 5 1/8" (x5)
<b>B</b> Ø cm.19	<b>B</b> Ø 7 1/2"
<b>A</b> Ø cm.19 (x5)	<b>A</b> Ø 7 1/2" (x5)
<b>B</b> Ø cm.27	<b>B</b> Ø 10 5/8"

7092

7094



**7092**  
Candelabro a 1 fiamma Silverplated  
Candlestick H cm. 28,5  
Chandelier  
Leuchter 1-flammig H 11 1/4"  
Candelabro

**7093**  
Candelabro a 3 fiamme Silverplated  
Candelabra, 3 arms H cm. 34,5  
Chandelier 3 flammes  
Leuchter 3-flammig H 13 5/8"  
Candelabro 3 luces

**7094**  
Candelabro a 5 fiamme Silverplated  
Candelabra, 5 arms H cm. 34,5  
Chandelier 5 flammes  
Leuchter 5-flammig H 13 5/8"  
Candelabro 5 luces

972

973



972

973

973P

972P

mm. 1,2  
**972-972P**  
 Secchiello per ghiaccio  
 Ice bucket  
 Seau à glaçons  
 Eisgefäß  
 Cubitera hielo

Ø cm 15    Ø 5 7/8"  
 H cm 18    H 7 1/8"  
 cl.150      oz. 50 3/4

mm. 1,2  
**973-973P**  
 Secchiello per spumante  
 Sparkling wine cooler  
 Seau à champagne  
 Wein- und Sektkühler  
 Cubo para champany

Ø cm 20,5    Ø 8 1/8"  
 H cm 24,5    H 9 5/8"  
 cl.500        gal. 1 1/3

666F

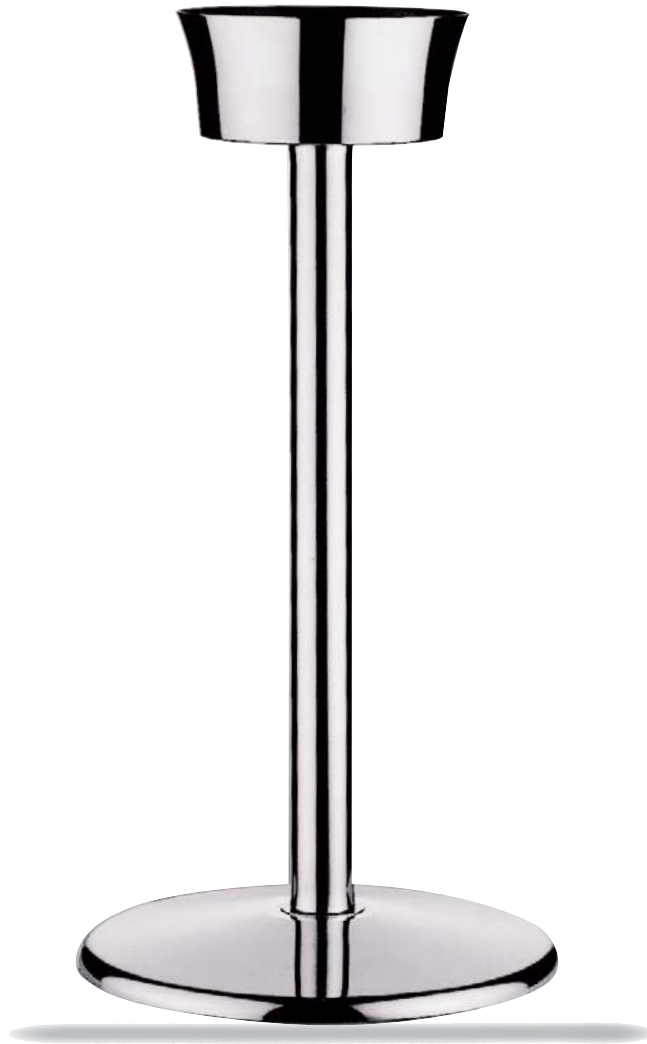

mm. 1,2  
 Colonna portasecchiello spumante  
 Wine cooler stand w/weighted base  
 Pied pour seau à champagne  
 Weinkühlerständer  
 Columna porta cubo champany

H cm. 67,5    H 26 5/8"

657



mm. 0,8 Coppa per champagne con inserto  
Champagne bowl with insert  
Vasque a champagne avec anneau porte-verre  
Champagner Bowl mit Gläser - Flaschenring  
Copa para champagne con anillo

Ø cm. 38 Ø 15"  
H cm. 29,5 H 11 5/8"  
lt. 15 gal. 4

949



mm. 1,2 Supporto per informazioni o menu Ø cm. 10 Ø 4"  
Menu / Card holder H cm. 10 H 4"  
Porte nom numéro de table  
Karten-Speisekartenhalter  
Porta informaciones o menu

986



mm. 0,8 Alzata per crudité rettangolare cm. 53 x 32,5 20 3/4" x 12 2/3" mm. 2,0 Portanumero  
Rectangular seafood presentation H cm. 9 H 3 1/2" Table number stand  
Serviteur à poisson crude rectang. lt. 9,0 gal. 2 Numbers etched to order  
Etagere, rech., für marinierte Fisch  
Porta pescado rectangular

A Ø cm 13 Ø 5 1/8"  
H cm 54 H 21 1/4"  
B Ø cm 13 Ø 5 1/8"  
H cm 30 H 11 7/8"

995



987



mm. 0,8 Alzata per crudité rettangolare cm. 53 x 32,5 20 3/4" x 12 2/3"  
Elevated rectangular seafood H cm. 25,8 H 10 1/7"  
presentation lt. 9,0 gal. 2  
Serviteur à poisson crude rectang.  
Etagere, rech., für marinierte Fisch  
Porta pescado rectangular

253



mm. 0,8 Rinfrescatore con piedini Ø cm 35 Ø 13 3/4"  
Yogurt cooler with feet H cm. 12 H 4 3/4"  
Rafrachisseur à yaourts a/socles lt. 2,0 oz. 67 3/5  
Yoghurtkühler mit Füßen  
Refrigerador para yogurt con pies

983

944



mm. 1,2 Zuppiera  
 Soup tureen  
 Soupière  
 Suppenterrine  
 Sopera

Ø cm. 14 - lt. 0,6	Ø 5 1/2" - oz. 20 1/4
Ø cm. 18 - lt. 1,2	Ø 7" - oz. 40 5/8
Ø cm. 20 - lt. 1,8	Ø 7 7/8" - oz. 60 7/8
Ø cm. 22 - lt. 2,5	Ø 8 5/8" - oz. 84 1/2
Ø cm. 24 - lt. 3,1	Ø 9 1/2" - oz. 104 7/8
Ø cm. 26 - lt. 3,9	Ø 10 1/4" - oz. 131 7/8
Ø cm. 28 - lt. 5,1	Ø 11" - gal. 1 1/4

945



mm. 1,2 Legumiera  
 Vegetable dish  
 Légumière  
 Lègumier  
 Legumbrera

Ø cm. 14 - lt. 0,6	Ø 5 1/2" - oz. 20 1/4
Ø cm. 18 - lt. 1,2	Ø 7" - oz. 40 5/8
Ø cm. 20 - lt. 1,8	Ø 7 7/8" - oz. 60 7/8
Ø cm. 22 - lt. 2,5	Ø 8 5/8" - oz. 84 1/2
Ø cm. 24 - lt. 3,1	Ø 9 1/2" - oz. 104 7/8
Ø cm. 26 - lt. 3,9	Ø 10 1/4" - oz. 131 7/8
Ø cm. 28 - lt. 5,1	Ø 11" - gal. 1 1/4

946



mm. 1,2 Coperchio per art. 944 - 945  
 Lid for art. 944 - 945  
 Couvercle pour art. 944 - 945  
 Deckel für art. 944 - 945  
 Tapa para art. 944 - 945

Ø cm. 14	Ø 5 1/2"
Ø cm. 18	Ø 7"
Ø cm. 20	Ø 7 7/8"
Ø cm. 22	Ø 8 5/8"
Ø cm. 24	Ø 9 1/2"
Ø cm. 26	Ø 10 1/4"
Ø cm. 28	Ø 11"

936



Cloche trasparente con pomolo  
 Transparent cloche with knob  
 Cloche transparente  
 Transparent Teller cloche  
 Tapa transparente

Ø cm. 12	Ø 4 3/4"
Ø cm. 22	Ø 8 1/2"
Ø cm. 28	Ø 11"

940



mm. 1,2 Servizio per caffè macchiato  
 Café au lait set  
 Service pour café au lait  
 Café au lait-Set  
 Juego café au lait

**939**  
 H cm 18  
 cl. 90

**940**  
 H cm 18  
 cl. 97

**939**  
 H 7 1/8"  
 oz. 30 1/2

**940**  
 H 7 1/8"  
 oz. 32 7/8

940E  
 Inserto per art. 940  
 Insert for art. 940  
 Insért pour art. 940  
 Einsatz für Art. 940  
 Inserto por art. 940

940E



mm. 1,2 Servizio per caffè macchiato  
 5pcs Sugar, milk and coffee set  
 Service sucre, lait et café 5 pièces  
 Milch-Kaffee-Zucker Set 5-Tlg.  
 Juego leche, café y azúcar 5 piezas

H cm 18 H 7 1/8"  
 cl. 30 (x5) oz. 10 1/8 (x5)

94005



943



mm. 1,2 Spargisale, portastecchi  
Salt & Pepper  
Sel/poivre/porte cure-dents  
Salz-Pfeffer-Zahnstocherbehälter  
Saleros y pimentero y palillero

H cm. 15 H 5 7/8"  
cl. 7,5 (x 2) oz. 2 1/2 (x 2)

942



mm. 1,2 Oliera  
Cruet  
2 pièces huile-vinaigre  
Essig-/Ölgestell  
Vinagreras

H cm. 22 H 8 5/8"  
cl. 22,5 (x 2) oz. 7 1/2 (x 2)

988



mm 1,2 Portamarmellata a 3 scomparti  
Jam pack holder 3 compartment  
Porte-confiture 3 comp.  
Marmeladgestell 3 Einsätze  
Marmeladero 3 comp.

H. cm. 15 H 5 7/8"  
cl. 28 (x3) oz. 9 1/2 (x3)

990



mm 1,2 Coppetta con vassoio  
Cup and tray  
Coupe avec plateau  
Schale mit Tablett  
Cuenco con bandeja

H cm. 11,5 H 4 1/2"  
Ø cm. 10 Ø 3 7/8"

947



Versatore per profumo a goccia  
Perfume drops dispenser  
Verseur de parfum en gouttes  
Tropf-Parfüm Aussteller  
Versador de perfume en gotas

Lungh. cm 18,5  
Length 7 5/8"

94003



mm. 1,2 Servizio per zucchero 3 e 4 pezzi  
Sugar set 3 and 4 pcs.  
Service pour sucre 3 et 4 pièces  
Sahne-/Zucker-Set 3- und 4-Tlg  
Juego azucar 3 y 4 piezas

H cm. 15 H 5 7/8"  
cl. 11 (x3) oz. 3 3/4 (x3)  
cl. 11 (x4) oz. 3 3/4 (x4)

94004



mm. 1,2 Mini burriera con coperchio  
Small butter dish w/lid  
Petit beurrier a/couvercle  
Mini Butterdose m/Deckel  
Platillo para mantequilla  
con tapa

cm. 12 x 6 4 3/4" x 2 1/3"  
cl. 15 oz. 5 1/8

922



# Giotto

257



mm. 1,2	Porta pasticcini con piedistallo	Ø cm. 14	Ø 5 1/2"
	Petit-fours stand with base	H cm. 8,7	H 3 1/2"
	Porte-petits-fours avec socle	Ø cm. 20	Ø 7 7/8"
	Petits Fours-Ständer	H cm. 13	H 5 1/8"
Porta dulces con pedestal		Ø cm. 28	Ø 11"
		H cm. 14,5	H 5 3/4"

258



mm. 1,2	Porta pasticcini con piedistallo	Ø cm. 14	Ø 5 1/2"
	Petit-fours stand with legs	Ø cm. 20	Ø 7 7/8"
	Porte-petits-fours avec socle	Ø cm. 28	Ø 11"
	Mokkaétagère 3 Ebenen	H cm. 27	H 10 5/8"
Porta dulces con pedestal			

220



mm. 1,2	Coppa per punch	Ø cm. 38	Ø 15"
	Punch bowl	H cm. 32,3	H 12 5/7"
	Bol à punch	lt. 15	gal. 4
	Punch Bowl		
Ponchera			

255



mm. 1,2	Presentoire	<b>25514</b>	<b>25514</b>
	3 misure	A Ø cm.14 (x5)	A Ø 5 1/2" (x5)
	3 sizes	B Ø cm.20	B Ø 7 7/8" (x5)
	3 tailles	<b>25520</b>	<b>25520</b>
3 Größen	A Ø cm.20 (x5)	A Ø 7 7/8" (x5)	
3 tamaños	B Ø cm.24	B Ø 9 1/2" (x5)	
	<b>25524</b>	<b>25524</b>	
	A Ø cm.24 (x5)	A Ø 9 1/2" (x5)	
	B Ø cm.28	B Ø 11"	

7070

7073



7071



7072



7073



Candelabro bugia	H cm. 13	Candelabro a 1 fiamma	H cm. 23,6	Candelabro a 3 fiamme	H cm. 23,6	Candelabro a 5 fiamme	H cm. 23,6
Candlestick	H 5 1/8"	Candlestick	H 9 1/4"	Candelabra, 3 arms	H 9 1/4"	Candelabra, 5 arms	H 9 1/4"
Chandelier		Chandelier		Chandelier 3 flammes		Chandelier 5 flammes	
Leuchter mit Kerze		Leuchter 1-flammig		Leuchter 3-flammig		Leuchter 5-flammig	
Candelabro		Candelabro		Candelabro 3 luces		Candelabro 5 luces	

141



mm. 1,2 NOVECENTO  
Vassoio  
Tray  
Plateau  
Tablett  
Bandeja

cm. 30 x 21	11 3/4" x 8 1/4"
cm. 35 x 24	13 3/4" x 9 1/2"
cm. 40 x 27	15 3/4" x 10 5/8"
cm. 45 x 31	17 3/4" x 12 1/4"
cm. 50 x 34	19 5/8" x 13 3/8"
cm. 60 x 42	23 5/8" x 16 1/2"
cm. 80 x 54	31 1/2" x 21 1/4"

144



mm. 1,2 NOVECENTO  
Vassoio con maniglie  
Tray with handles  
Plateau avec anses  
Tablett mit Griffen  
Bandeja con asas

cm. 40 x 27	15 3/4" x 10 5/8"
cm. 45 x 31	17 3/4" x 12 1/4"
cm. 50 x 34	19 5/8" x 13 3/8"
cm. 60 x 42	23 5/8" x 16 1/2"
cm. 80 x 54	31 1/2" x 21 1/4"

141GN



mm. 1,2 NOVECENTO  
Gastronorm

1/1 GN	1/1 GN
cm. 53 x 32,5	20 7/8" x 12 2/3"

2/1 GN2	2/1 GN2
cm. 65 x 53	25 5/8" x 20 7/8"

144GN



mm. 1,2 NOVECENTO  
Gastronorm con maniglie  
Gastronorm with handles  
Gastronorm avec anses  
Gastronorm mit Griffen  
Gastronorm con asas

1/1 GN  
cm. 53 x 32,5  
20 7/8" x 12 2/3"

2/1 GN2  
cm. 65 x 53  
25 5/8" x 20 7/8"

146GN



mm. 1,2 NOVECENTO  
Gastronorm

1/1 GN	1/1 GN
cm. 53 x 32,5	20 7/8" x 12 2/3"

2/1 GN2	2/1 GN2
cm. 65 x 53	25 5/8" x 20 7/8"

146



mm. 1,2 Vassoio con maniglia sovrapponibile  
Tray with stackable handles  
Plateau avec anses empilables  
Tablett mit stapelbaren Griffen  
Bandeja con asas empilables

cm. 30 x 21	11 3/4" x 8 1/4"
cm. 35 x 24	13 3/4" x 9 1/2"
cm. 40 x 27	15 3/4" x 10 5/8"
cm. 45 x 31	17 3/4" x 12 1/4"
cm. 50 x 34	19 5/8" x 13 3/8"
cm. 60 x 42	23 5/8" x 16 1/2"
cm. 80 x 54	31 1/2" x 21 1/4"

137



mm. 1,2 Vassoio quadro NOVECENTO cm. 60 x 60 23 5/8" x 23 5/8"  
 Square tray »  
 Plateau carré »  
 Tablett, quadratisch »  
 Bandeja cuadrada »

256



mm. 1,2 Vassoio rotondo GIOTTO Ø cm. 27 Ø 10 5/8"  
 Round tray » Ø cm. 35 Ø 13 3/4"  
 Plateau rond » Ø cm. 40 Ø 15 3/4"  
 Tablett rund »  
 Bandeja redonda »

138



mm. 1,2 Vassoio quadro con maniglie NOVECENTO cm. 60 x 60 23 5/8"x23 5/8"  
 Square tray with handles »  
 Plateau carré avec anses »  
 Tablett, quadratisch mit Griffen »  
 Bandeja cuadrada con asas »

AIRLINES

140



mm. 1,2 Vassoio per compagnie aeree 200140 ATLAS  
 Airlines tray for on board service cm. 38,5 x 27,5  
 Ideal for aircraft and corporates jets 15 1/8" x 10 4/5"  
 Chariot de service 200140K KSSU  
 Bordservice -Tablett f. Airlines cm. 40,4 x 27,9  
 Bandeja de servicio para comp. aéreas 15 7/8" x 11"

139



mm. 1,2 Vassoio quadr.c/man.sovrappon. cm. 60 x 60 23 5/8" x 23 5/8"  
 Square tray w/stackable handles  
 Plateau carré a/anses empilables  
 Tablett quadr.m/stapelb. Griffen  
 Bandeja cuadrada c/asas empil.

250

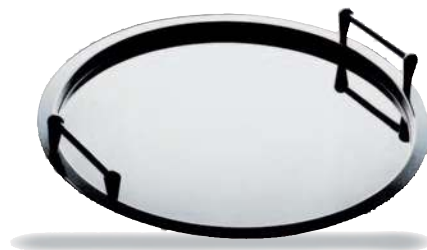

mm. 1,2 Vassoio con maniglia sovrapponibile Ø cm. 35 Ø 13 3/4"  
 Tray with stackable handles Ø cm. 40 Ø 15 3/4"  
 Plateau avec anses empilables  
 Tablett mit stapelbaren Griffen  
 Bandeja con asas empilables

295



mm. 1,2 Vassoio tondo con piedistallo Ø cm. 35 Ø 13 3/4"  
 Round tray with base H cm. 12,5 H 4 7/8"  
 Plateau rond avec socle  
 Obstschale, rund auf Fuß  
 Bandeja redonda con pedestal

297



mm. 1,2 Vassoio ovale con piedistallo cm. 45 x 30 17 3/4" x 11 3/4"  
 Oval tray with base H cm. 12,5 H 4 7/8"  
 Plateau oval avec socle  
 Obstschale, oval auf Fuß  
 Bandeja oval con pedestal

296



mm. 1,2 Vassoio rettang. con piedistallo cm. 45 x 30 17 3/4" x 11 3/4"  
 Rectangular tray with base H cm. 12,5 H 4 7/8"  
 Plateau rectang. avec socle  
 Tablett, rechteckig auf Fuß  
 Bandeja rectang. con pedestal

298



mm. 1,2 Piatto torta con piedistallo Ø cm. 40 Ø 15 3/4"  
 Cakes plate with base H cm. 9,5 H 3 3/4"  
 Plat à tarte avec socle  
 Kuchenplatte auf Fuß  
 Bandeja tarta con pedestal

287



mm. 2,0 Vassoio rettangolare per buffet cm. 30x21 11 3/4" x 8 1/4"  
 Rectangular Tray for buffet cm. 40x27 15 3/4" x 10 5/8"  
 Plateau rectangulaire pour buffet cm. 50x34 19 5/8" x 13 3/8"  
 Buffet -Tablett, rechteckig cm. 60x42 23 5/8" x 16 1/8"  
 Bandeja rectangular para entremes

288



mm. 2,0 Vassoio tondo per buffet Ø cm. 30 Ø 11 3/4"  
 Round Tray for buffet Ø cm. 40 Ø 15 3/4"  
 Plateau rond pour buffet Ø cm. 50 Ø 19 5/8"  
 Buffet-Tablett rund Ø cm. 60 Ø 23 5/8"  
 Bandeja redonda para entremes

7004A



mm. 0,8 Alzata per pesce crudo  
Marinated fish holder  
Serviteur à poisson crude  
Etagere für marinierten Fisch  
Porta pescado

Ø cm. 34 Ø 13 3/4"  
Ø cm. 41 Ø 16 1/8"  
H cm. 55 H 21 5/8"

7004B



mm. 1,2 Alzata per pesce crudo  
Marinated fish holder  
Serviteur à poisson crude  
Etagere für marinierten Fisch  
Porta pescado

Ø cm. 22 Ø 8 5/8"  
Ø cm. 34 Ø 13 3/8"  
H cm. 38 H 15"

7002B



mm. 1,2 Alzata portafrutta NOVECENTO  
Fruit holder » cm. 35x24 13 3/4" x 9 1/2"  
Serviteur » cm. 45x31 17 3/4" x 12 1/4"  
Etagere » cm. 60x42 23 5/8" x 16 1/2"  
Frutero » H cm. 70 H 27 5/8"

7001B



mm. 1,2 Alzata portafrutta GIOTTO  
Fruit holder » Ø cm. 27 Ø 10 5/8"  
Serviteur » Ø cm. 35 Ø 13 3/4"  
Etagere » Ø cm. 40 Ø 15 3/4"  
Frutero » H cm. 70 H 27 5/8"

67301



67304

mm. 1,2 Portaggiaccio termico con coperchio Ø cm 14 Ø 5 1/2"  
 Insulated ice-bucket with lid H cm 13,5 H 5 1/9"  
 Seau à glaçons thermique avec couvercle lt. 0,70 oz. 23 2/3  
 Isolier-Eisgefäß, mit Deckel Ø cm 24 Ø 9 1/2"  
 Cubitera hielo térmica con tapa H cm 23 H 9"  
 lt. 2,75 oz. 93

668



669

mm. 1,2 Secchiello spumante e ghiaccio Ø cm 24 Ø 9 1/2"  
 Sparkling wine cooler / Ice bucket H cm 23 H 9"  
 Seau à champagne et à glaçons lt. 2,75 oz. 93  
 Wein- Sektkühler / Eisgefäß Ø cm 14 Ø 5 2/3"  
 Cubo para champany y para hielo H cm 13,5 H 5 1/9"  
 lt. 0,70 oz. 23 2/3

666E



mm. 1,2 Colonna portasecchiello spumante H cm. 67,5 H 26 5/8"  
 Wine cooler stand  
 Pied pour seau à champagne  
 Weinkühlerständer  
 Columna porta cubo champany

686



mm. 1,2 Champagnera 5 bott. c/pied. Ø cm. 40 Ø 15 3/4"  
 Giant Champagne bucket 5 bot. H cm. 38,5 H 15 1/6"  
 Seau à champagne p/5 bout. lt. 15 gal. 4  
 Champagner Bowl 5 Fläsche  
 Cubo de champagne p/5 bot.

685



mm. 1,2 Champagnera 5 bott. s/pied. Ø cm. 40 Ø 15 3/4"  
 Giant Champagne bucket 5 bot. H cm. 21,8 H 8 3/5"  
 Seau à champagne p/5 bout. lt. 15 gal. 4  
 Champagner Bowl 5 Fläsche  
 Cubo de champagne p/5 bot.

666I



mm. 1,2 Colonna portabottiglie spumante H cm. 78 H 30 5/7"  
 Wine cooler stand  
 Pied pour seau à champagne  
 Weinkühlerständer  
 Columna porta cubo champany

674



mm. 1,2 Spumantiera termica 5 bott. s/pied. Ø cm. 40 Ø 15 3/4"  
 Giant insulated Champagne bucket 5b. H cm. 21,8 H 8 3/5"  
 Seau à champagne thermique p/5 bou. lt. 15 gal. 4  
 Isolier Champagner Bowl 5 Fläsche  
 Cubo térmico para champagne p/5 bot.

265



NEW

207



mm. 1,2 Vassoio per pasticceria  
Patisserie tray  
Plateau pour patisserie  
Patisserie Tablett  
Bandeja para pasteleria

cm. 24,5 x 17 9 5/8" x 6 3/4"  
cm. 30 x 21 11 3/4" x 8 1/4"  
cm. 34 x 24 13 3/8" x 9 1/2"

con piedistallo  
with foot  
avec socle  
mit Fuss  
con pies

cm. 24,5 x 17 9 5/8" x 6 3/4"  
cm. 30 x 21 11 3/4" x 8 1/4"  
cm. 34 x 24 13 3/8" x 9 1/2"  
H cm. 13 H 5 1/9"

516



516



51610



518

mm. 1,2 Portabustine da zucchero  
Sugar packet holder  
Pot à sucre  
Zuckerstangengefäß  
Azucarera

**516**  
cm. 10 x 7  
H cm. 3

**516**  
4" x 2 3/4"  
H 1 1/8"

**51610**  
cm. 10 x 5  
H cm. 4,5

**51610**  
4" x 2"  
H 1 3/4"

Cesto portapane, porta agrumi  
Basket for bread/ for fruit  
Panier / Porte agrumes  
Brot-/Früchtekorb  
Cesto por pan/ por cítricos  
mm. 1,2

cm. 33 x 26  
H cm. 20

13" x 10 1/5"  
H 7 7/8"

704



Portatovaglioli  
Napkin holder  
Distributeur de serviettes  
Serviettenhalter  
Portaservilletas  
mm. 1,2

cm. 13 x 13

5 1/9" x 5 1/9"

270



Portatovaglioli  
Napkin holder  
Distributeur de serviettes  
Serviettenhalter  
Portaservilletas  
mm. 1,2

cm. 12,5 x 4,5  
H cm. 7

5" x 1 7/8"  
H 2 3/4"



Portastuzzicadenti  
Toothpick container  
Porte-cure-dents  
Zahnstocherbehälter  
Porta-palillos  
mm. 1,2

cm. 11 x 3

4 1/3" x 1 1/5"

424

206



mm. 1,2 Vassoio per pasticceria cm. 26 x 12 10<sup>1</sup>/<sub>4</sub>" x 4<sup>3</sup>/<sub>4</sub>"  
 Patisserie tray cm. 60 x 12 23<sup>3</sup>/<sub>5</sub>" x 10<sup>1</sup>/<sub>5</sub>"  
 Plateau pour patisserie  
 Patisserie Tablett  
 Bandeja para pasteleria

205



con piedistallo cm. 26 x 12  
 with foot cm. 60 x 12  
 avec socle H cm. 13  
 mit Fuss  
 con pies 10<sup>1</sup>/<sub>4</sub>" x 4<sup>3</sup>/<sub>4</sub>"  
 23<sup>3</sup>/<sub>5</sub>" x 10<sup>1</sup>/<sub>5</sub>"  
 H 5<sup>1</sup>/<sub>9</sub>"

153

NEW



mm. 1,2 Vassoio portabicchieri impilabile cm. 38 x 27  
 Stackable tray for glasses  
 Plateau porte verres empilable  
 Stapelbare Gläserträger Tablett 15" x 10<sup>5</sup>/<sub>8</sub>"  
 Bandeja porta vasos impilable

505

NEW



mm. 1,2 Vassoio per carrelli cm. 56 x 40 16" x 22"  
 Tray for rack trolley  
 Plateau pour chariot porte-plateau  
 Tablett für Rack  
 Bandeja para estante

150



mm. 1,2 Platto concavo Ø cm. 14 Ø 5<sup>1</sup>/<sub>2</sub>"  
 Crescent plate Ø cm. 18 Ø 7"  
 Plateau concave Ø cm. 20 Ø 7<sup>7</sup>/<sub>8</sub>"  
 Konkave Platte Ø cm. 22 Ø 8<sup>5</sup>/<sub>8</sub>"  
 Plato concavo Ø cm. 24 Ø 9<sup>1</sup>/<sub>2</sub>"  
 Ø cm. 26 Ø 10<sup>1</sup>/<sub>4</sub>"  
 Ø cm. 28 Ø 11"

NEW



mm. 1,2 Cestino per pane Ø cm. 20 Ø 7<sup>7</sup>/<sub>8</sub>"  
 Bread basket Lt. 2 oz. 67<sup>3</sup>/<sub>5</sub>"  
 Corbeille pour pan  
 Brotschale  
 Cuenco para pan

154

284



mm. 1,2 Vassoio rettangolare da servizio cm. 30x21 11<sup>3</sup>/<sub>4</sub>" x 8<sup>1</sup>/<sub>4</sub>"  
 Rectangular service tray cm. 35x24 13<sup>3</sup>/<sub>4</sub>" x 9<sup>1</sup>/<sub>2</sub>"  
 Plateau rectangulaire pour service cm. 40x27 15<sup>3</sup>/<sub>4</sub>" x 10<sup>5</sup>/<sub>8</sub>"  
 Tablett rechteckig für Service cm. 45x31 17<sup>3</sup>/<sub>4</sub>" x 12<sup>1</sup>/<sub>4</sub>"  
 Bandeja rectangular da servicio cm. 50x34 19<sup>5</sup>/<sub>8</sub>" x 13<sup>3</sup>/<sub>8</sub>"  
 cm. 60x42 23<sup>5</sup>/<sub>8</sub>" x 16<sup>1</sup>/<sub>8</sub>"

283



mm. 1,2 Vassoio tondo da servizio Ø cm. 27 Ø 10<sup>5</sup>/<sub>8</sub>"  
 Round service tray Ø cm. 35 Ø 13<sup>3</sup>/<sub>4</sub>"  
 Plateau rond pour service Ø cm. 40 Ø 15<sup>3</sup>/<sub>4</sub>"  
 Tablett rund für Service  
 Bandeja redonda por servicio

415



mm. 1,2 Cloche per servizio, mantieni calore Ø cm. 20  
 Cloche for service, heat keeper  
 Cloche pour service, mainteneur de chaleur  
 Service-Cloche, Wärmepflege Ø 7<sup>7</sup>/<sub>8</sub>"  
 Cloche de servicio, mantenedor de calor.



225



Cloche trasparente con pomolo Ø cm. 12 Ø 4<sup>3</sup>/<sub>4</sub>"  
 Transparent cloche with knob Ø cm. 22 Ø 8<sup>5</sup>/<sub>8</sub>"  
 Cloche transparente Ø cm. 28 Ø 11"  
 Transparente Teller cloche  
 Tapa transparente

155

NEW



mm. 1,2 Porta noccioli Ø cm. 6 Ø 2<sup>2</sup>/<sub>5</sub>"  
 Olive seeds jar H cm. 5 H 2"  
 Porte noyaux cl. 5 oz. 1<sup>3</sup>/<sub>4</sub>"  
 Aderhalter  
 Porta granos

721



mm. 1,2  
Coppa termica con cloche  
Insulated cup with cloche  
Coupe thermique avec cloche  
Isolier-Eisfruchtbecher mit Deckel  
Copa térmica con tapa

Ø cm. 8,5    Ø 3 1/3"  
cl. 15        oz. 6

259



mm. 1,2  
Ciotola con base  
Bowl with base  
Bol avec socle  
Obstschale auf Fuss  
Cuenco con pedestal

Ø cm. 20        Ø 5 2/3"  
H cm. 14,3     H 7 7/8"  
lt. 2,1           gal. 1/2  
  
Ø cm. 28        Ø 11"  
H cm. 18,3     H 7 1/5"  
lt. 5,7           gal. 1 1/2

864



GALA  
Cestino semitraforato  
Half fretworked basket  
Corbeille demi-ajouré  
Schale, halbgelocht  
Frutero semiperforado

Ø cm. 22        Ø 8 5/8"  
H cm. 5,7       H 2 1/4"  
cl. 150           oz. 50 3/4

mm. 0,8

834



GALA  
Cestino portafrutta  
Round basket  
Corbeille ronde  
Schale, rund  
Frutero redondo

Ø cm. 22        Ø 8 5/8"  
H cm. 5,7       H 2 1/4"  
cl. 150           oz. 50 3/4

mm. 0,8

Ø cm. 34        Ø 13 3/8"  
H cm. 5,7       H 2 1/4"  
cl. 500           gal. 1 1/3



GALA  
Cestino traforato  
Fretworked basket  
Corbeille ajouré  
Schale, gelocht  
Frutero perforado

Ø cm. 22        Ø 8 5/8"  
H cm. 5,7       H 2 1/4"  
cl. 150           oz. 50 3/4

mm. 0,8

863

254



Supporto per informazioni o menu  
Menu / Card holder  
Porte nom numéro de table  
Karten / Speisekartenhalter  
Porta informaciones o menu

Ø cm. 6        Ø 2 1/2"  
H cm. 9        H 3 1/2"

Portamenù  
Menù holder  
Porte-menu  
Menükartenhalter  
Portamenù



907

cm. 21 x 13,5    8 5/8" x 5 3/8"  
H cm 29,7       H 11 3/4"



994

Portanumero  
Table number stand  
Numbers etched to order  
Porte numéro de table  
Tischnummernständer  
Porta numero de mesa

**A**  
Ø cm 8,3        Ø 3 1/4"  
H cm 47,3       H 18 5/8"

**B**  
Ø cm 8,3        Ø 3 1/4"  
H cm 24           H 9 1/2"

**A**  
Ø 3 1/4"        H 18 5/8"

**B**  
Ø 3 1/4"        H 9 1/2"

712



mm. 1,2 Chillcup per burro e caviale con base  
Chillcup for butter and caviar with base  
Chillcup pour beurre et caviar avec socle  
Chillcup für Butter und Kaviar mit Fuß  
Chillcup para mantequilla y caviar con pedestal

713



Chillcup per burro  
Chillcup for butter  
Chillcup pour beurre  
Chillcup für Butter  
Chillcup para mantequilla

Ø cm. 12  
cl. 15  
Ø 4 3/4"  
oz. 5 1/8



Servizio per caviale  
Caviar set  
Service à caviar complet  
Kaviarschale  
Servicio para caviar

Ø cm. 18  
cl. 15  
Ø 7 1/8"  
oz. 5 1/8

301



301A

301C

301B

mm. 0,8 Chillcup per cocktail di gamberetti Supreme bowl, complete Coupe à crevettes Chillcup für Hummercocktail Chillcup para coctél mariscos	301 Ø cm. 15	Ø 5 7/8"
	cl. 17,5	oz. 6
	301A Ø cm. 15	301A Ø 5 7/8"
	301B Ø cm. 13,5	301B Ø 5 3/8"
	301C Ø cm. 9,5	301C Ø 3 3/4"
	cl. 17,5	oz. 6

725

722



mm. 0,6 Piatino per coppa gelato  
Under liner for ice-cream bowl  
Petit plat soucoupe glace  
Unterteller für Eisschale  
Platillo melado

Ø cm. 12 Coppa per gelato e macedonia  
Ice-cream and salad fruit bowl with stand  
Coupe à glace et macédoine  
Eisfrüchteschale  
Copa helado y macedonia

Ø cm. 8,5  
cl. 15  
Ø 3 3/4"  
oz. 5 1/8

mm. 1,2 Coppa per gelato  
Ice-cream bowl  
Coupe à glace  
Eisschale  
Copa helado

Ø cm. 9,5  
cl. 17

Ø 3 3/4"  
oz. 6

723



498



mm. 1,2 Completo oliera con spargisale a 5 H cm. 22 H 8 5/8"  
 Cruet and salt cellar set 5 pcs. cl. 22,5 (x 2) oz. 7 1/2 (x 2)  
 Service huile-vinaigre 5 pcs. cl. 7,5 (x 3) oz. 2 1/2 (x 3)  
 Essig-/Ölgestell 5-Tlg.  
 Convoy vinagreras con saleros 5 pzs

507



mm. 1,2 Completo oliera con spargisale a 4 H cm. 22 H 8 5/8"  
 Cruet and salt cellar set 4 pcs. cl. 22,5 (x 2) oz. 7 1/2 (x 2)  
 Service huile-vinaigre 4 pcs. cl. 7,5 (x 2) oz. 2 1/2 (x 2)  
 Essig-/Ölgestell 4-Tlg.  
 Convoy vinagreras con saleros 4 pzs

506



mm. 1,2 Oliera GALA H cm. 22 H 8 5/8"  
 Cruet » cl. 22,5 (x 2) oz. 7 1/2 (x 2)  
 2 pièces huile-vinaigre »  
 Essig-/Ölgestell »  
 Vinagreras »

525



mm. 1,2 Formaggera GALA cl. 20 oz. 6 3/4  
 Parmesan cheese basin »  
 Fromagère »  
 Käsedose »  
 Quesera-Azucarero »

513



mm. 1,2 Spargisale, portastecchi GALA H cm. 15  
 Salt-cellar with toothpick container » cl. 7,5 (x 3)  
 Sel-poivre/porte cure-dents »  
 Salz-Pfeffer-Zahnstocherbehälter » H 5 7/8"  
 Saleros y pimentero y palillero » oz. 2 1/2 (x 3)

702



mm. 1,2 Mini burriera con coperchio cm. 12 x 6 4 3/4" x 2 1/3"  
 Small butter dish w/lid cl. 15 oz. 5 1/8  
 Petit beurrier a/couvercle  
 Mini Butterdose m/Deckel  
 Platillo para mantequilla  
 con tapa



Dry Aged

DRY A G E D



620



Pietra ollare cm. 26 x 26 10 1/4" x 10 1/4"  
 Soapstone  
 Ardoise  
 Speckstein  
 Pizarra

700

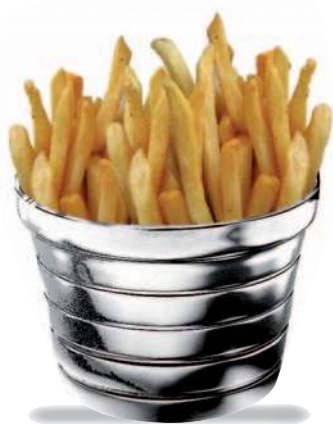

H cm 10 H 4"  
 cl. 35 oz. 11 7/8

mm. 1,2 Portapatatine fritte  
 French fry holder for table  
 Porte pommes frites pour table  
 Kartoffelbehälter für Tisch  
 Porta patatas fritas por mesa

260



Ø cm 10 H 3 3/4"  
 H cm 9,5 Ø 3 7/8"

289



H cm. 10 H 3 7/8"  
 Ø cm. 6 Ø 2"

902

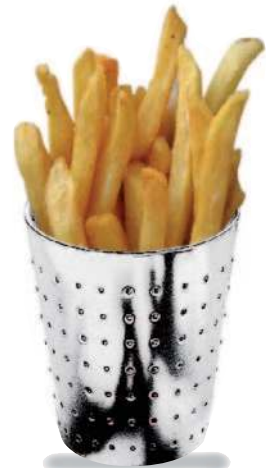

H cm 8 H 3 1/4"  
 Ø cm 7 Ø 2 3/4"

282



mm. 1,2 Braciere con pietre naturali Ø cm. 15 Ø 5 7/8"  
 Table grill with natural stones Ø cm. 22 Ø 8 5/8"  
 Brasero avec pierres naturelles Ø cm. 32 Ø 12 5/8"  
 Feuerschale mit Natursteine  
 Hoguera c/piedras naturales

572



Ampolla cl. 20 oz. 6 3/4  
 Cruet cl. 34 oz. 11 1/2  
 Huilliere cl. 62 oz. 21  
 Öl-/Essigflaschen  
 mit Spender  
 Vinagrera

1136

1136

10001136



10001136

UNI

Coltello bistecca cm. 21,3 8 1/4"

Steak knife

Couteau entrecôte

Steakmesser

Cuchillo bistek

10101136

10231136



10101136

NORMA

10231136

BOHEME

Coltello bistecca cm. 23 9 1/8"

Steak knife

Couteau entrecôte

Steakmesser

Cuchillo bistek

10141136

1020B1136

10341136



10141136

ROMA

1020B1136

10341136

NATURA

Coltello bistecca cm. 22,7 8 7/8"

Steak knife

Couteau entrecôte

Steakmesser

Cuchillo bistek

1144

1144

10001144



Coltello bistecca americano

cm. 25 9 5/8"

American steak knife

Couteau entrecôte américain

Amerikanisches Steakmesser

Cuchillo bistek americano

28215



mm. 1,2 Braciére con pietre naturali  
Table grill with natural stones  
Brasero avec pierres naturelles  
Feuerschale mit Natursteine  
Hoguera c/piedras naturales

Ø cm. 15 Ø 5 7/8"

28222



mm. 1,2 Braciére con pietre naturali  
Table grill with natural stones  
Brasero avec pierres naturelles  
Feuerschale mit Natursteine  
Hoguera c/piedras naturales

Ø cm. 22 Ø 8 5/8"

28232



mm. 1,2 Braciére con pietre naturali  
Table grill with natural stones  
Brasero avec pierres naturelles  
Feuerschale mit Natursteine  
Hoguera c/piedras naturales

Ø cm. 32 Ø 12 5/8"



A differenza del carbone, le pietre laviche rilasciano il calore molto lentamente e possono mantenere il cibo in cottura, senza cuocerlo eccessivamente

Unlike charcoal, lava stones release the heat very slowly and can cook food without over-cooking.

NEW

DRY AGED

NEW

78125



mm. 1,2 Sauteuse

cm. 25 9 5/8"

78130



mm. 1,2 Sauteuse

cm. 30 11 3/4"

78135



mm. 1,2 Sauteuse

cm. 35 13 3/4"

78140



mm. 1,2 Sauteuse

cm. 40 15 3/4"



574



Antipastiera quadra in vetro cm. 24,5 x 24,5 9<sup>5</sup>/<sub>8</sub>" x 9<sup>5</sup>/<sub>8</sub>"  
 Hors d'oeuvre tray in glass  
 Plat à hors d'oeuvre en verre  
 Vorspeisenplatte aus Glas  
 Entremesera en vidrio

575



Piatto quadro in vetro cm. 24,5 x 24,5 9<sup>5</sup>/<sub>8</sub>" x 9<sup>5</sup>/<sub>8</sub>"  
 Square plate in glass  
 Plateau carré en verre  
 Platte, viereckig, aus Glas  
 Plato cuadrado en vidrio

582



Supporto per cm. 43 x 14 16<sup>7</sup>/<sub>8</sub>" x 5<sup>1</sup>/<sub>2</sub>"  
 Multifunction stand for  
 Support multi-usages pour  
 Schalenhalter  
 Soporte multiuso para

581



Supporto per cm. 36 x 14 14<sup>1</sup>/<sub>8</sub>" x 5<sup>1</sup>/<sub>2</sub>"  
 Multifunction stand for  
 Support multi-usages pour  
 Schalenhalter  
 Soporte multiuso para

570



mm. 1,2 UNO  
 Cremiera  
 Cream jug  
 Crémier  
 Sahnegießer  
 Jarrita lechera  
 Ø cm. 6 Ø 2<sup>3</sup>/<sub>8</sub>"  
 H cm. 8,8 H 3<sup>1</sup>/<sub>2</sub>"  
 cl. 16 oz 5<sup>3</sup>/<sub>8</sub>

594



mm. 1,2 UNO  
 Cremiera con piedistallo  
 Cream jug with base  
 Crémier avec socle  
 Sahnegießer auf Fuss  
 Jarrita lechera con pedestal  
 Ø cm. 6 Ø 2<sup>3</sup>/<sub>8</sub>"  
 H cm. 9 H 3<sup>1</sup>/<sub>2</sub>"  
 cl. 16 oz 5<sup>3</sup>/<sub>8</sub>

576



Servizio per pinzimonio in vetro Ø cm. 28 Ø 11"  
 Salad set in glas H cm. 8 H 3 1/8"  
 Service pour salade en verre cl. 300 oz. 101 1/2  
 Service für Salat aus Glas  
 Servicio para ensalada en vidrio

290576



Servizio per pinzimonio Ø cm. 28 Ø 11"  
 Set for salad serving cl. 300 oz. 101 1/2  
 Service à crudités  
 Set "Salatdressing"  
 Servicio para ensaladas

**Ciambella termica per supporto Milleusi.** La ciambella termica è usata per mantenere a lungo le temperature calde o fredde. Nel primo caso va riscaldata in forno ad una temperatura variabile tra i 160° C ed i 250° C, nel secondo caso va conservata in freezer a -14° C. In queste condizioni e in grado di mantenere la temperatura desiderata (da -5° C a +50° C) per un periodo che varia dai 20 ai 30 minuti

**Thermal serving unit for multifunction stand.**

The thermal serving unit is used to maintain heat or cold. In the first case, it must be heated in an oven at 160° C (+320° F) -250° C (+482° F). In the second case in a Freezer at -14° C (-57° F). In these conditions it is able to maintain the food either hot or cold for a period between 20 and 30 minutes at the desired temperature (from -5° C (-41° F) to +50° C (+122° F)).

**Disque thermique pour support multi-usages.** Le disque thermique est utilisé pour maintenir la chaleur ou le froid. Dans un cas, le disque est préchauffé dans le four à une température variant de 160° C a 250° C. Dans un second cas, le disque peut être refroidi jusqu'à -14° C. Dans ces conditions, le disque est en mesure de maintenir la chaleur ou la fraîcheur pendant un temp variable de 20 a 30 minutes, a la température voulue (de -5° C a +50° C).



583  
 Ciambella termica per supporti  
 Thermal serving unit for stands  
 Disque thermique pour support  
 Thermische Ringröhre für Hälter  
 Bobina térmica para soportes  
 Ø cm. 12 - Ø 4 3/4"

**Der Warmhalteteller mit Thermikelement** dient zum Servieren von warm- oder kalzuhaltenden Speisen, also sowohl zur Speicherung von Wärme als auch von Kälte. Zum Warmhalten erhitzt man das runde Thermikelement im Ofen auf 160 bis 250° C. Zum Kalthalten kühlt man im Gefrierfach das runde Thermikelement auf -14° C ab. Derart eingefügt in die Vertiefung des Warmhaltetellers kann man Speisen bis zu 30 min bei einer gewünschten Temperatur zwischen -5° C und +50° C kalt bzw. warm halten.

**Bobina térmica para soporte multiuso.** La bobina térmica puede ser utilizada para mantener el calor o el frío. En el primer caso, se calienta en el horno a una temperatura variable entre 160° C y 250° C; en el segundo, se mete en un congelador a -14° C. En estas condiciones, es capaz de mantener los alimentos calientes o fríos durante un periodo que oscila entre 20 y 30 minutos a la temperatura deseada (de -5° C a +50° C).



582

580



Pirofila ovale in fine china cm. 37 x 24 14 5/8" x 9 3/8"  
 Fine china oval bowl cl. 300 oz. 101 1/2  
 Plat oval en porcelaine à feu  
 Auflaufform, oval aus Porzellan  
 Pirophila oval en porcelana

579



Lasagnera in fine china cm. 34,5 x 24,5 13 5/8" x 9 5/8"  
 Fine china Lasagne's bowl cl. 300 oz. 101 1/2  
 Plat rectangulaire en porcelaine à feu  
 Auflaufform, quadr. aus Porzellan  
 Fuente para Lasagne en porcelana



# Room Service

272



mm. 0,8  
 Piatto termico con copripiatto e ciambella termica  
 Insulated plate with cover and thermal serving unit  
 Plat thermique avec couvre-plat et disque thermique  
 Warmhalteteller mit Tellerglocke und Thermikelement  
 Plato térmico con cubre platos y bobina térmica

Ø cm. 28,5  
 Ø cm. 30,5  
 Ø cm. 33,7

Ø 11<sup>1</sup>/<sub>4</sub>"  
 Ø 12"  
 Ø 13<sup>1</sup>/<sub>4</sub>"

273



mm. 0,8  
 Piatto termico con cloche e ciambella termica  
 Insulated plate with cloche and thermal serving unit  
 Plat thermique avec cloche et disque thermique  
 Warmhalteteller mit Tellerglocke und Thermikelement  
 Plato térmico con tapadera y bobina térmica

Ø cm. 28,5  
 Ø cm. 30,5  
 Ø cm. 33,7

Ø 11<sup>1</sup>/<sub>4</sub>"  
 Ø 12"  
 Ø 13<sup>1</sup>/<sub>4</sub>"

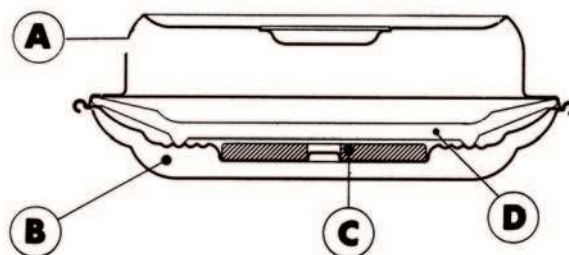

La ciambella termica © è usata per mantenere a lungo le temperature calde o fredde.

Nel primo caso va riscaldata in forno ad una temperatura variabile tra i 60°C ed i 150°C; nel secondo caso in Freezer a -14°C. In queste condizioni è in grado di mantenere la temperatura desiderata (da -5°C a +50°C) per un periodo che varia dai 20 ai 30 minuti.

The Thermal serving unit © maintains food at hot or cold temperatures for about 30 minutes.

The disk can be placed in an oven at 140°C (302°F) or in a freezer at -14°C (-57°F).

Le disque thermique © est utilisé pour maintenir la chaleur ou le froid. Dans un cas, le disque est préchauffé dans le four à une température variant de 60°C à 150°C. Dans un second cas, le disque peut être refroidi jusqu'à -14°C. Dans ces conditions, le disque est en mesure de maintenir la chaleur ou la fraîcheur pendant un temps variable de 20 à 30 minutes, à la température voulue (de -5°C à -50°C).

Der Warmhalteteller mit Thermikelement dient zum Servieren von warm- oder kaltzuhaltenden Speisen, also sowohl zur Speicherung von Wärme als auch von Kälte. Zum Warmhalten erhitzt man das runde Thermikelement im Ofen auf 60° bis 150° C. Zum Kalthalten kühlt man im Gefrierfach das runde Thermikelement auf -14° C ab. Derart eingefügt in die die Vertiefung des Warmhaltetellers kann man Speisen bis zu 30 min bei einer gewünschten Temperatur zwischen -5° C und +50° C kalt bzw. warm halten.

La bobina térmica © puede ser utilizada para mantener el calor o el frío. En el primer caso se calienta en el horno a una temperatura variable entre 60°C y 150°C; en el segundo, se mete en un congelador a -14°C. En estas condiciones es capaz de mantener los alimentos calientes o fríos durante un periodo que oscila entre 20 y 30 minutos a la temperatura deseada (de -5° C a +50° C).

Una rivoluzionaria soluzione per un servizio ai piani di alta classe, nella massima sicurezza anti-incendio, evitando l'uso di fiamme o fornelli.

A revolutionary solution for room service, eliminating the need of fuel or electric wires.

C'est une solution révolutionnaire pour un Service à l'Étage de qualité en conformité avec les règles de sûreté anti-incendie et en évitant l'usage de flammes ou feux ouverts.

Dies ist eine revolutionäre Lösung für den hohen Anspruch an excellenten Zimmerservice. Man vermeidet dabei den Gebrauch von offenem Feuer oder elektrischen Platten und vermeidet Konflikte mit den Brandschutzrichtlinien der jeweiligen Länder

Es una solución revolucionaria para un servicio de habitación de alta calidad que respeta las normas de seguridad contra incendios, pues evita el peligro de l'uso de llamas y hornillos encendidos.

425  
Tiffin' box

H cm. 21,3  
cm. 24,5 x 25,3

H 8 2/5"  
9 5/8" x 10"

Colori personalizzati a disposizione  
Custom colors available  
Couleurs personnalisées  
Benutzerdefinierte Farben verfügbar  
Colores personalizados disponible



NEW

ROOM SERVICE

NEW

425



153



153

mm. 1,2 Vassoio per carrelli      cm. 56 x 40    22" x 16"  
 Tray for rack trolley  
 Plateau pour chariot porte-plateau  
 Tablett für Rack  
 Bandeja para estante

429

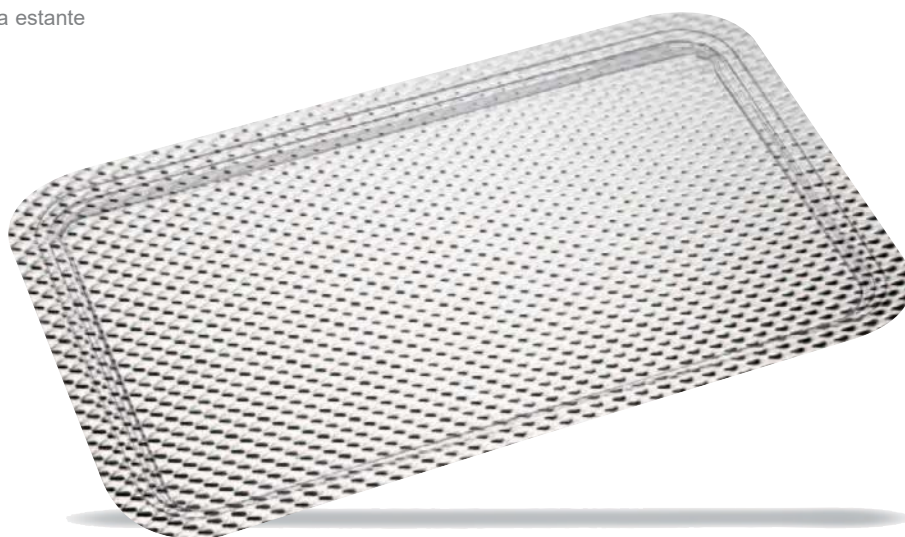

429

mm. 1,0 Vassoio per carrelli      cm. 63 x 45    24 11/16" x 17 3/4"  
 Tray for rack trolley  
 Plateau pour chariot porte-plateau  
 Tablett für Rack  
 Bandeja para estante

429



429

mm. 1,0 Vassoio per carrelli      cm. 45 x 31    17 3/4" x 12 1/4"  
 Tray for rack trolley  
 Plateau pour chariot porte-plateau  
 Tablett für Rack  
 Bandeja para estante





# Menu & Banquet

305



mm. 1,2 Vassoio rettangolare  
Rectangular tray  
Plateau rectangulaire  
Tablett, rechteckig  
Bandeja rectangular  
cm. 40,5 x 27,5 15<sup>7</sup>/<sub>8</sub>" x 10<sup>3</sup>/<sub>4</sub>"  
cm. 45 x 31 17<sup>3</sup>/<sub>4</sub>" x 12<sup>1</sup>/<sub>4</sub>"

316



315 316  
mm. 1,2 Sottobicchiere e sottobottiglia  
Glass and bottle coaster  
Dessous de verre et de bouteille  
Glasuntersatz - Flaschenteller  
Posavaso y Posabotella  
cm. 10 x 10 4" x 4"  
cm. 12,5 x 12,5 5" x 5"

323



mm. 1,2 Sottopiatto quadrato  
Square charger  
Assiette de bienvenue carré  
Platzteller, viereckig  
Bajo plato cuadrado  
cm. 32 x 32 12<sup>1</sup>/<sub>2</sub>" x 12<sup>1</sup>/<sub>2</sub>"

313



mm. 0,8 Sottopiatto  
Charger  
Assiette de bienvenue  
Platzteller  
Bajo plato  
Ø cm. 31 Ø 12 1/4"

319



mm. 1,2 Vassoio quadrato  
Square plate  
Plateau carré  
Tablett, viereckig  
Bandeja cuadrada  
cm. 32 x 32 12<sup>1</sup>/<sub>2</sub>" x 12<sup>1</sup>/<sub>2</sub>"

320



mm. 1,2 Vassoio "Tête à tête"  
"Tête à tête" tray  
Plateau "Tête à tête"  
Tablett "Tête à tête"  
Bandeja "Tête à tête"  
Ø cm. 22 Ø 8 5/8"

312



mm. 1,2 Antipastiera 4 scomparti in cristallo cm. 40,5 x 27,5 15<sup>7</sup>/<sub>8</sub>" x 10<sup>3</sup>/<sub>4</sub>"  
 Hors-d'oeuvre tray 4 compt.  
 Plat à hors-d'oeuvre 4 comp. cristal  
 Vorspeisenplatte 4 Einsatze  
 Entremesera

325



mm. 1,2 Lasagnera rettangolare cm. 40,5 x 27,5 15<sup>7</sup>/<sub>8</sub>" x 10<sup>3</sup>/<sub>4</sub>"  
 Set for Lasagne lt. 3 oz. 102 1/9  
 Service pour Lasagne  
 Set mit Porzellanschale, rech.  
 Servicio para Lasagne

324



mm. 1,2 Risottiera tonda Ø cm. 31 Ø 12 1/4"  
 Set for risotti lt. 2 oz. 67 3/5  
 Service pour risotto  
 Set mit Porzellanschale, rund  
 Servicio para arroces

309



mm. 1,2 Portatovaglioli cm. 22 x 22 8<sup>5</sup>/<sub>8</sub>" x 8<sup>5</sup>/<sub>8</sub>"  
 Napkin holder  
 Distributeur de serviettes  
 Serviettenhalter  
 Portaservilletas

31802



mm. 1,2 Portaspezie cm. 15 x 15 5 7/8" x 5 7/8"  
 Aromatic condiments set H cm. 25,5 H 10"  
 Service pour aromatiques cl. 11 (x 8) oz. 3 3/4 (x 8)  
 condiments  
 Gewürzständer  
 Servicio para aromaticos y  
 condimentos

308



mm. 1,2 Cestino per pane  
Basket  
Corbeille  
Brotschale  
Cuenco

cm. 22 x 22 8<sup>5</sup>/<sub>8</sub>" x 8<sup>5</sup>/<sub>8</sub>" mm. 1,2  
cl. 80 oz. 27

Allacciatovaglioli  
Napkins ring  
Rond de serviette  
Serviettenring  
Servilletero

Ø cm. 6 Ø 2 3/8"

317



306



mm. 1,2 Completo oliera con spargisale  
Cruet and salt cellar set 4 pcs.  
Service huile-vinaigre 4 pcs.  
Essig-/Ölgestell 4-Tlg.  
Convoy vinagreras con saleros

H cm. 19 H 7<sup>3</sup>/<sub>8</sub>"  
cl. 18 (x2) oz. 6 (x2)  
cl. 11 (x2) oz. 3<sup>3</sup>/<sub>4</sub> (x2)

mm. 1,2 Formaggera  
Parmesan cheese basin  
Fromagère  
Kasedose  
Quesera-Azucarero

cl. 20 oz. 6 3/4

307



310



mm. 1,2 Portabicchieri di carta  
Paper cup holder  
Porte-gobelets de papier  
Papierbecherständer  
Portavasos de papel

cm. 21 x 11 8<sup>3</sup>/<sub>16</sub>" x 4<sup>1</sup>/<sub>4</sub>"  
H cm. 22,8 H 8 7/8"

mm. 1,2 Portapiatti di plastica  
Plastic paper plate dispenser  
Porte-plateau de plastique  
Stand für Plastik Platten  
Portaplatos de plastica

Ø cm. 22 Ø 8 5/8"

321



164



mm. 1,2 Vassoio rettangolare  
Rectangular tray  
Plateau rectangulaire  
Tablett, rechteckig  
Bandeja rectangular

cm. 40 x 29 15<sup>3</sup>/<sub>4</sub>" x 11<sup>3</sup>/<sub>8</sub>"  
cm. 49 x 36 19<sup>1</sup>/<sub>4</sub>" x 14<sup>1</sup>/<sub>8</sub>"

165



mm. 1,2 Vassoio rotondo  
Round tray  
Plateau ronde  
Tablett, rund  
Bandeja redonda

Ø cm. 35 Ø 13 <sup>3</sup>/<sub>4</sub>"

168



mm. 1,2 Completo olera con spargisale  
Cruet and salt cellar set 4 pcs  
Service huile-vinaigre 4 pièces  
Essig-/Ölgestell 4-Tlg.  
Convoy vinagreras con saleros  
4 piezas

H cm. 20 H 7<sup>7</sup>/<sub>8</sub>"  
cl. 18 (x 2) oz. 6 (x 2)  
cl. 11 (x 2) oz. 3<sup>3</sup>/<sub>4</sub> (x 2)

169



mm. 1,2 Formaggera  
Parmesan cheese basin  
Fromagère  
Kasedose  
Quesera-Azucarero

cl. 20 oz. 6 <sup>3</sup>/<sub>4</sub>



408



mm. 1,2 TALAMO  
Vassoio rettangolare  
Rectangular tray  
Plateau rectangulaire  
Tablett, rechteckig  
Bandeja rectangular

cm. 29 x 23 11<sup>3</sup>/<sub>8</sub>" x 9"  
cm. 47 x 37 18<sup>1</sup>/<sub>2</sub>" x 14<sup>1</sup>/<sub>2</sub>"

409



mm. 1,2 TALAMINO  
Vassoio quadrato  
Square tray  
Plateau carré  
Tablett, viereckig  
Bandeja cuadrada

cm. 37 x 37 14<sup>1</sup>/<sub>2</sub>" x 14<sup>1</sup>/<sub>2</sub>"

406

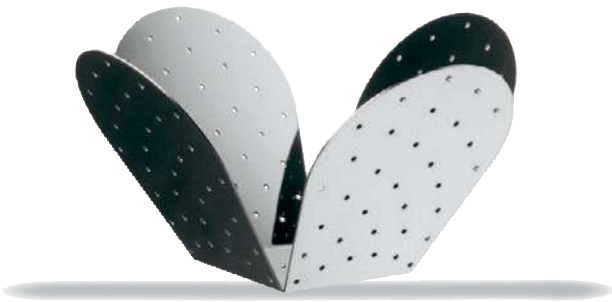

mm. 1,2 BOCCIOLO  
Cestino  
Basket  
Corbeille  
Obstschale  
Frutero

Ø cm. 24,5 Ø 9<sup>2</sup>/<sub>3</sub>"  
H cm. 13,5 H 5<sup>1</sup>/<sub>3</sub>"  
lt. 4 gal. 1

407



mm. 1,2 BOCCIOLINO  
Cestino  
Basket  
Corbeille  
Obstschale  
Frutero

Ø cm. 16,5 Ø 6<sup>1</sup>/<sub>2</sub>"  
H cm. 15,5 H 6<sup>1</sup>/<sub>9</sub>"  
lt. 2,64 oz. 89<sup>1</sup>/<sub>4</sub>

410



mm. 1,2 COROLLA  
Completo oliera con spargisale  
Cruet and salt cellar set  
Service huile-vinaigre  
Essig-/Ölgestell 4-Tlg.  
Convoy vinagreras con saleros  
H cm. 20- cl.18(x2) cl.11(x2)  
H 7<sup>7</sup>/<sub>8</sub>" - oz.6(x2) oz.3<sup>3</sup>/<sub>4</sub> (x2)

411

PISTILLA  
Formaggera  
Parmesan cheese basin  
Fromagère  
Käsedose  
Quesera-Azucarero  
cl. 20  
oz. 6<sup>3</sup>/<sub>4</sub>

505



mm. 1,2 COROLLA  
Cestello portacondimenti  
Basket for aromatic condiments  
Corbeille pour aromatiques condiments  
Essig-und Öl Flaschenhalter  
Cesto para aromaticos y condimentos

H cm. 20  
cl.25(x2)  
cl.11(x2)

H 7<sup>7</sup>/<sub>8</sub>"  
oz.8<sup>1</sup>/<sub>2</sub>(x2)  
oz.3<sup>3</sup>/<sub>4</sub>(x2)

331



mm. 1,2 Sottopiatto  
Charger  
Assiette de bienvenue  
Platzteller  
Bajo plato  
Ø cm. 33    Ø 13"

333

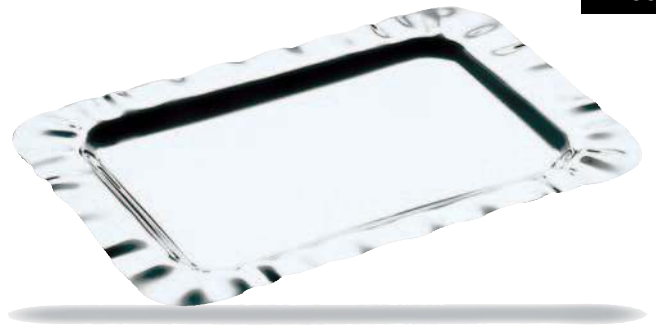

mm. 1,2 Vassoio rettangolare  
Rectangular tray  
Plateau rectangulaire  
Tablett, rechteckig  
Bandeja rectangular  
cm. 50 x 34 19<sup>5</sup>/<sub>8</sub>" x 13<sup>3</sup>/<sub>8</sub>"

332



mm. 1,2 Vassoio ovale  
Oval tray  
Plateau oval  
Tablett, oval  
Bandeja oval  
cm. 49 x 33 19<sup>1</sup>/<sub>4</sub>" x 13"

337



mm. 1,2 Cestino tondo  
Round basket  
Corbeille ronde  
Obstschale, rund  
Frutero redondo  
Ø cm. 31    Ø 12<sup>1</sup>/<sub>4</sub>"  
cl. 125    oz. 42 <sup>1</sup>/<sub>4</sub>

335



mm. 1,2 Completo oliera con spargisale  
Cruet and salt cellar set  
Service huile-vinaigre  
Essig-/Ölgestell 4-Tlg.  
Convoy vinagreras con saleros  
H cm. 21  
cl.22,5(x2)  
cl.7,5(x2)  
H 8<sup>1</sup>/<sub>4</sub>"  
oz.7<sup>1</sup>/<sub>2</sub>(x2)  
oz.2<sup>1</sup>/<sub>2</sub>(x2)

336



mm. 1,2 Formaggera  
Parmesan cheese basin  
Fromagère  
Käsedose  
Quesera-Azucarero  
cl. 20    oz. 6<sup>3</sup>/<sub>4</sub>

201



mm. 1,2 Vassoio  
Tray  
Plateau  
Tablett  
Bandeja  
cm. 30 x 24 11<sup>3</sup>/<sub>4</sub>" x 9<sup>1</sup>/<sub>2</sub>"  
cm. 40 x 31 15<sup>3</sup>/<sub>4</sub>" x 12<sup>1</sup>/<sub>4</sub>"  
cm. 50 x 39 19<sup>5</sup>/<sub>8</sub>" x 15<sup>3</sup>/<sub>8</sub>"

202



mm. 1,2 Vassoio con maniglie  
Tray with handles  
Plateau avec anses  
Tablett mit Griffen  
Bandeja con asas  
cm. 40 x 31 15<sup>3</sup>/<sub>4</sub>" x 12<sup>1</sup>/<sub>4</sub>"  
cm. 50 x 39 19<sup>5</sup>/<sub>8</sub>" x 15<sup>3</sup>/<sub>8</sub>"

203



mm. 1,2 Vassoio  
Tray  
Plateau  
Tablett  
Bandeja  
Ø cm. 25 Ø 9 <sup>7</sup>/<sub>8</sub>"  
Ø cm. 31 Ø 12 <sup>1</sup>/<sub>4</sub>"

199

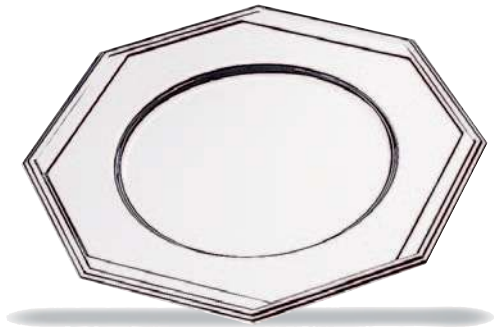

mm. 1,2 Sottopiatto  
Charger  
Assiette de bienvenue  
Platzteller  
Bajo plato  
Ø cm. 31 Ø 12<sup>1</sup>/<sub>4</sub>"

716



mm. 0,8 Piattino per burro con coperchio e griglia  
Butter dish with inserted grill and cover  
Beurrer avec grill et couvercle  
Butterkühler mit Einsatzsieb und Deckel  
Plato para mantequilla con rejilla y tapa  
Ø cm. 9 cl. 25 Ø 3<sup>1</sup>/<sub>2</sub>"  
oz 8 <sup>1</sup>/<sub>2</sub>

210

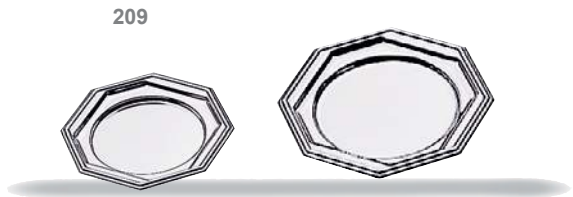

mm. 0,8 Sottobicchiere e sottobottiglia  
Glass and bottle coaster  
Dessous de verre et de bouteille  
Glasuntersatz - Flaschenteller  
Posavaso y Posabotella  
209  
Ø cm. 10,5 Ø 4<sup>1</sup>/<sub>8</sub>"  
Ø cm. 12,5 Ø 4<sup>7</sup>/<sub>8</sub>"

502



mm. 0,8 Completo oliera con spargisale  
Cruet and salt cellar set  
Service huile-vinaigre 4 pièces  
Essig-/Ölgestell 4-Tlg.  
Convoy vinagreras con saleros 4 pzs

H cm. 21 H 8 1/4"  
cl. 22,5 (x 2) oz. 7 1/2 (x 2)  
cl. 7,5 (x 2) oz. 2 1/2 (x 2)

522



mm. 0,8 Formaggera  
Parmesan cheese basin  
Fromagère  
Käsedose  
Quesera-Azucarero

cl. 20 oz. 6 3/4

844



mm. 1,2 Cestino rettangolare  
Rectangular basket  
Corbeille rectangulaire  
Obstschale rechteckig  
Panera rectangular

cm. 30 x 24 11 3/4" x 9 1/2"  
cl. 200 oz. 67 5/8

843



mm. 1,2 Cestino  
Round Basket  
Corbeille  
Obstschale  
Frutero

Ø cm. 25 Ø 9 7/8"  
cl. 150 oz. 50 3/4

103

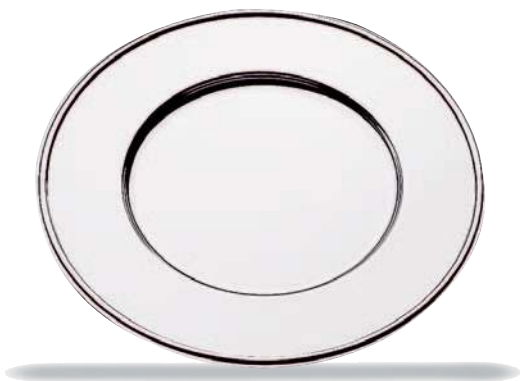

mm. 1,2 Sottopiatto Ø cm. 33 Ø 13"  
 Charger Ø cm. 35 Ø 13 3/4"  
 Assiette de bienvenue  
 Platzteller  
 Bajo plato

131



mm. 0,8 Sottopiatto RAFFAELLO Ø cm. 32,5 Ø 12 3/4"  
 Charger »  
 Assiette de bienvenue »  
 Platzteller »  
 Bajo plato »

294



mm. 1,2 Porta pasticcini con piedistallo Ø cm. 19 Ø 7 1/2"  
 Petit-fours stand with base H cm. 14,5 H 5 3/4"  
 Porte-petits-fours avec socle  
 Petit Fours-Ständer Ø cm. 24 Ø 9 1/2"  
 Porta dulces con pedestal H cm. 14,5 H 5 3/4"

7003A



mm. 1,2 Alzata portafrutta 2 piani Ø cm. 24 Ø 9 1/2"  
 Fruit holder 2 layers Ø cm. 31 Ø 12 1/4"  
 Serviteur 2 etages H cm. 24,5 H 9 5/8"  
 Etagere 2 stufig  
 Frutero 2 pisos

293



mm. 1,2 Porta pasticcini con piedistallo 2 Piani Ø cm. 12 Ø 4 3/4"  
 Petit-fours stand with base 2 Layers Ø cm. 19 Ø 7 1/2"  
 Porte-petits-fours avec socle 2 Etages H cm. 27 H 10 5/8"  
 Mokkaetagere 2 Ebenen  
 Porta dulces con pedestal 2 Pisos

7003B



mm. 1,2 Alzata portafrutta 3 piani Ø cm. 19 Ø 7 1/2"  
 Fruit holder 3 layers Ø cm. 24 Ø 9 1/2"  
 Serviteur 3 etages Ø cm. 31 Ø 12 1/4"  
 Etagere 3 stufig H cm. 35,5 H 14"  
 Frutero 3 pisos

204



mm. 1,2 Porta macaron  
Macarons server  
Porte macarons  
Macaronsträger  
Porta macaron  
Ø cm. 15    Ø 5 7/8"  
H cm. 11,5    H 4 1/2"  
cl. 20    oz. 6 3/4

715



mm.0,8 Piattino per burro con coperchio e griglia    Ø cm. 9    Ø 3 1/2"  
Butter dish with inserted grill and cover    cl. 20    oz. 6 3/4  
Beurrer avec grille et couvercle  
Butterdose mit Einsatzsieb und Deckel  
Plato para mantequilla con rejilla y tapa

105



mm. 1,2 Sottobicchiere  
Glass coaster  
Dessous de verre  
Glasuntersatz  
Posavasos  
Ø cm. 10    Ø 4"

106



mm.1,2 Sottobottiglia  
Bottle coaster  
Dessous de bouteille  
Flaschenteller  
Posabotella  
Ø cm. 12    Ø 4 3/4"

208



mm. 1,2 Piattino per pane  
Bread tray  
Plat pour pan  
Brot Platte  
Plato para pan  
Ø cm. 14    Ø 5 1/2"

292



mm. 1,2 Servizio per zucchero con cristallo  
Sugar set with crystal  
Service à sucre avec cristal  
Zuckerständer mit Kristalleinsätzen  
Servicio para azúcar con cristales  
Ø cm. 33    Ø 13"  
cl. 15(x3)    oz. 5(x3)

497



mm. 1,2 Completo oliera con spargisale 5 pz. H.cm.21 H. 8 1/4"  
 Cruet and salt cellar set 5 pcs cl. 30 (x2) oz. 10 1/8 (x2)  
 Service huile-vinaigre 5 pièces cl. 8 (x3) oz. 2 3/4 (x3)  
 Essig-Ölgestell 5-Tlg. oz. 2 3/4 (x3)  
 Vinagreras 5 pza

509



mm. 1,2 Completo oliera con spargisale 4 pz. H.cm.21 H. 8 1/4"  
 Cruet and salt cellar set 4 pcs cl. 30 (x2) oz. 10 1/8 (x2)  
 Service huile-vinaigre 4 pièces cl. 8 (x2) oz. 2 3/4 (x2)  
 Essig-Ölgestell 4-Tlg. oz. 2 3/4 (x2)  
 Vinagreras 4 pza

508



mm. 1,2 Oliera H.cm.21 H. 8 1/4"  
 Cruet cl. 30 (x2) oz. 10 1/8 (x2)  
 2 pièces huile-vinaigre  
 Essig-Ölgestell 2 Tlg.  
 Vinagreras 2 pza

510



mm. 1,2 Spargisale portastecchi con base H. cm.14 H. 5 1/2"  
 Salt cellar w/toothpick container w/base cl. 8 (x3) oz. 2 3/4 (x3)  
 Sel, poivre, porte cure-dents a/socle  
 Salz-Pfeffer-Zahnstocherbehälter 3-tlg.  
 Sal & Pimenta & palillero 3 pza

350



Cristallo per spargisale art. 510  
 Salt and pepper container for art. 510  
 Cristal pour art. 510  
 Ersatzglass für Art. 510  
 Cristal por saleros art. 510  
 cl. 8  
 oz. 2 3/4

Ampolla  
 Cruet  
 Huilliere  
 Öl-/Essigflasche  
 Vinagrera  
 H cm. 18 - cl. 30  
 H 7 1/8" - oz. 10 1/8

510ST



Portastecchi senza base cl. 8 oz. 2 3/4  
 Toothpick container w/out base  
 Porte cure-dents sans/socle  
 Zahnstocherbehälter ohne Fuß  
 Palillero sin pedestal

611



mm. 1,2 Formaggera  
Parmesan cheese basin  
Fromagère  
Käsedose  
Quesera - Azucarero  
cl. 20 oz. 6 3/4

512

430491SS



Cristallo per spargisale art. 512-602  
Crystal glass container for art. 512-602  
Cristal avec capsule pour art. 512-602  
Erzatzglass mit Kapsel für art. 512-602  
Cristal por saleros art. 512-602  
cl. 11 - oz. 3 3/4

mm. 1,2 Spargisale-portastecchi  
Salt cellar with toothpick container  
Sel + poivre + cure dents  
Salz-Pfeffer-Zahnstocherbehälter  
Saleros y pimenteros y pallillero  
H. cm.14 - cl. 11(x2)  
H. 5 1/2" - oz. 3 3/4 (x2)

602



mm. 1,2 Completo olera con spargisale  
Cruet and salt cellar set  
Service huile-vinaigre 4 pièces  
Essig-Ölgestell 4-tlg.  
Convoy vinagreras con saleros  
H. cm 19 H. 7 1/2"  
cl. 18(x2) oz. 6(x2)  
cl. 11(x2) oz. 3 3/4(x2)

601

430602



mm. 1,2 Oliera  
Cruet  
2 pièces huile-vinaigre  
Essig-Ölgestell  
Vinagreras  
H. cm 19 H. 7 1/2"  
cl. 18(x2) oz. 6(x2)

603



mm. 1,2 Oliera portacondimenti  
Cruet for aromatic condiments  
Huilière pour aromatiques condiments  
Gewürzmenage  
Vinagreras para aromaticos  
y condimentos  
H. cm 14,5 H. 5 3/4"  
cl. 11(x2) oz. 3 3/4(x2)

304



304  
mm 1,2 Portamarmellata a 3 scomparti  
Jam pack holder 3 compt.  
Porte-confiture 3 comp.  
Marmeladegestell 3 Einsätze  
Marmeladero 3 comp.  
H. cm. 19 - H. 7 1/2"

604

mm. 1,2 Oliera a 3 pezzi  
Cruet 3 pcs  
Huilière 3 pcs  
Menage 3-Tlg.  
Vinagreras 3 pzas  
H. cm. 19 -cl.18(x2)-cl. 11  
H. 7 1/2" - oz.6(x2) oz.3 3/4

231



mm. 0,8	Piatto ovale da portata bordo rinforzato	cm. 25 x 17	9 7/8" x 6 3/4"
	Oval serving plate with reinforced edges	cm. 30 x 21	11 3/4" x 8 1/4"
	Plat oval de service bord renforcé	cm. 35 x 24	13 3/4" x 9 1/2"
	Bratenplatte oval	cm. 40 x 27	15 3/4" x 10 5/8"
	Fuente ovalada borde reforzado	cm. 45 x 32	17 3/4" x 12 5/8"
		cm. 50 x 35	19 5/8" x 13 3/4"
		cm. 60 x 41	23 5/8" x 16 1/8"

241



mm. 0,8	Piatto ovale da portata pesce bordo rinforzato	cm. 55 x 24
	Oval serving fish plate with reinforced edges	cm. 70 x 29
	Plat à poisson oval bord renforcé	
	Fischplatte, oval	21 5/8" x 9 1/2"
	Fuente pescado borde reforzado	27 1/2" x 11 3/8"

233



mm. 1,2	Piatto ovale da portata mod. pesante	cm. 30 x 22	11 3/4" x 8 5/8"
	Oval serving plate with reinforced edges heavy mod.	cm. 35 x 26	13 3/4" x 10 1/2"
	Plat oval de service bord renforcé Mod. pesant	cm. 40 x 28	15 3/4" x 11"
	Bratenplatte, oval, schweres Mod.	cm. 45 x 31	17 3/4" x 12 1/4"
	Fuente ovalada nuevo modelo	cm. 50 x 34	19 5/8" x 13 3/8"

243



mm. 1,2	Piatto ovale da portata pesce mod. pesante	cm. 55 x 25
	Oval serving fish plate heavy weight	cm. 70 x 27
	Plat à poisson modèle Pesant	
	Fischplatte, oval, schweres Mod.	21 5/8" x 9 7/8"
	Fuente ovalada pescado nuevo modelo	27 1/2" x 10 5/8"

251



mm. 0,8	Piatto rotondo da portata bordo rinforzato	Ø cm. 27	Ø 10 5/8"
	Round serving plate with reinforced edges	Ø cm. 30	Ø 11 3/4"
	Plat rond de service bord renforcé	Ø cm. 35	Ø 13 3/4"
	Bratenplatte, rund	Ø cm. 40	Ø 15 3/4"
	Bandeja redonda borde reforzado		

269



mm. 0,8	Copripiatto sovrapponibile	GALA	Ø cm.28	Ø 11"
	Stackable cover for round plate	»		
	Couvre-plat	»		
	Stapelbarer Teller cloche	»		
	Cubre platos	»		



263



mm. 0,8 Piatto tondo per legumi a 3 sc. Ø cm. 27 Ø 10 5/8"  
 3 sections vegetable dish  
 Plat à légumes rond - 3 compt.  
 Teller rund 3 Abteilungen  
 Bandeja para legumbres 3 comp.

264



mm. 0,8 Coperchio per piatto tondo art. 263 Ø cm. 25 Ø 9 7/8"  
 Lid for art. 263  
 Couvercle pour plat rond art. 263  
 Deckel für Teller 3 Abtlg.  
 Tapa para bandeja redonda art. 263

266



mm. 0,8 Piatto ovale per legumi a 2 sc. cm. 30 x 21 11 3/4" x 8 1/4"  
 2 section vegetable dish  
 Plat à légumes oval - 2 comp.  
 Teller oval, 2 Abteilungen  
 Bandeja para legumbres 2 comp.

267



mm. 0,8 Coperchio per piatto ovale art. 266 cm. 27 x 18 10 5/8" x 7 1/8"  
 Lid for art. 266  
 Couvercle pour plat oval art. 266  
 Deckel für Teller, 2 Abtlg.  
 Tapa para bandeja ovalada art. 266

235



mm. 1,2 Vassoio per gratin cm. 35 x 20 13 3/4" x 7 1/8"  
 Tray for "gratin" cm. 40 x 24 15 3/4" x 9 1/2"  
 Plat à "gratin"  
 Gratinplatte  
 Bandeja gratinar  
 15 3/4" x 9 1/2"

236



mm. 0,8 Coperchio per Art. 235 cm. 35 x 20 13 3/4" x 7 1/8"  
 Lid for Art. 235 cm. 40 x 24 15 3/4" x 9 1/2"  
 Couvercle pour Art. 235  
 Deckel für Art. 235  
 Tapa para Art. 235

253



mm. 0,8 Cloche per piatto rotondo  
Cloche for round plate  
Cloche pour plat rond  
Tellercloche für Bratenplatte rund  
Tapa para fuente redonda

Ø cm. 27	Ø 10 5/8"
Ø cm. 35	Ø 13 3/4"
Ø cm. 40	Ø 15 3/4"

245



mm. 0,8 Cloche per piatto ovale  
Cloche for oval plate  
Cloche pour plat oval de service  
Tellercloche für Bratenplatte oval  
Tapa para fuente ovalada

cm. 30	11 3/4"
cm. 35	13 3/4"
cm. 40	15 3/4"
cm. 45	17 3/4"
cm. 50	19 5/8"

211



mm. 0,6 Vassoio rettangolare per pasticceria  
Rectangular tray for cakes  
Plat à tarte rectangulaire  
Gebäckplatte, rechteckig  
Bandeja

cm. 26 x 19	10 1/4" x 7 1/2"
cm. 31 x 21	12 1/4" x 8 1/4"

238



mm. 1,2 Vassoio per gratin e gastronomia  
Tray for "Gratin-gastronomy"  
Plat à "Gratin et gastronomie"  
Gratinplatte für Gastronomie  
Bandeja para gratinar y gastronomia

cm. 25 x 18	9 7/8" x 7 1/8"
cm. 30 x 22	11 3/4" x 8 5/8"
cm. 35 x 25	13 3/4" x 9 7/8"
cm. 40 x 29	15 3/4" x 11 3/8"
cm. 45 x 31	17 3/4" x 12 1/4"

247



mm. 0,8 Cloche con pomolo per sottopiatto  
Cloche with knob for under plate  
Cloche pour sous-assiette  
Tellercloche  
Tapa para fuente redonda

Ø cm. 7,5	Ø 3"
Ø cm. 10	Ø 4"
Ø cm. 10,5	Ø 4 1/16"
Ø cm. 13	Ø 5 1/16"
Ø cm. 13,2	Ø 5 1/5"
Ø cm. 14	Ø 5 1/2"
Ø cm. 14,5	Ø 5 5/7"
Ø cm. 20	Ø 7 7/8"
Ø cm. 22	Ø 8 5/8"
Ø cm. 24	Ø 9 1/2"
Ø cm. 26	Ø 10 1/4"
Ø cm. 28	Ø 11"
Ø cm. 30	Ø 12 1/8"
Ø cm. 31	Ø 12 1/8"
Ø cm. 32	Ø 12 5/8"
Ø cm. 33	Ø 13"

268



mm. 0,8 Copripiatto sovrapponibile  
Stackable cover for round plate  
Couvre-plat  
Stapelbarer Tellercloche  
Cubre platos

Ø cm. 20	Ø 7 7/8"
Ø cm. 24	Ø 9 1/2"
Ø cm. 26	Ø 10 1/4"
Ø cm. 27	Ø 10 5/8"
Ø cm. 28	Ø 11"
Ø cm. 30	Ø 11 3/4"
Ø cm. 31	Ø 12 3/8"
Ø cm. 33	Ø 13"

732



mm. 1,2 Zuppiera nuovo modello  
 Soup tureen new mod.  
 Soupière nouveau modele  
 Suppenterrine neues Mod.  
 Sopera nuevo Modelo

Ø cm. 14 - lt. 0,6	Ø 5 1/2" - oz. 20 1/4
Ø cm. 18 - lt. 1,2	Ø 7" - oz. 40 5/8
Ø cm. 20 - lt. 1,8	Ø 7 7/8" - oz. 60 7/8
Ø cm. 22 - lt. 2,5	Ø 8 5/8" - oz. 84 1/2
Ø cm. 24 - lt. 3,1	Ø 9 1/2" - oz. 104 7/8
Ø cm. 26 - lt. 3,9	Ø 10 1/4" - oz. 131 7/8
Ø cm. 28 - lt. 5,1	Ø 11" - gal. 1 1/4

782



mm. 1,2 Legumiera nuovo modello  
 Vegetable dish new model  
 Légumiere nouveau modele  
 Lègumier neues Modell  
 Legumbrera nuevo Modelo

Ø cm. 14 - lt. 0,6	Ø 5 1/2" - oz. 20 1/4
Ø cm. 18 - lt. 1,2	Ø 7" - oz. 40 5/8
Ø cm. 20 - lt. 1,8	Ø 7 7/8" - oz. 60 7/8
Ø cm. 22 - lt. 2,5	Ø 8 5/8" - oz. 84 1/2
Ø cm. 24 - lt. 3,1	Ø 9 1/2" - oz. 104 7/8
Ø cm. 26 - lt. 3,9	Ø 10 1/4" - oz. 131 7/8
Ø cm. 28 - lt. 5,1	Ø 11" - gal. 1 1/4

736



mm. 1,2 Coperchio per art. 732 - 782  
 Lid for art. 732 - 782  
 Couvercle pour art. 732 - 782  
 Deckel für art. 732 - 782  
 Tapa para art. 732 - 782

Ø cm. 14	Ø 5 1/2"
Ø cm. 18	Ø 7"
Ø cm. 20	Ø 7 7/8"
Ø cm. 22	Ø 8 5/8"
Ø cm. 24	Ø 9 1/2"
Ø cm. 26	Ø 10 1/4"
Ø cm. 28	Ø 11"

701



10131140

mm. 1,2 Salsiera mod. "Aladino" cl. 10 oz. 3 3/8  
 Gravy boat mod. "Aladino" cl. 15 oz. 5 1/8  
 Saucière mod. "Aladino" cl. 30 oz. 10 1/8  
 Salsiera mod. "Aladino"

Mestolino per salsa Lungn. cm. 18,7 Long. 7 3/8"  
 Ladle for gravy boat  
 Cuillère à sauce  
 Saucenlöffel  
 Cacillo para salsiera

511



430511SS

mm. 0,8 Completo spargisale-portastecchi  
 Salt-cellar with toothpick container  
 Sel+poivre+porte cure-dents  
 Salz+Pfeffer+Zahnstocherbehälter  
 Saleros y pimentero y palillero

H cm. 14	H 5 1/2"
cl. 8	oz. 2 3/4

731



mm. 1,2 Zuppiera monoporzione demitasse  
 Soup cup with base  
 Soupiere sur socle avec anses  
 Suppentasse auf Fuss  
 Taza para sopa con pedestal

Ø cm 12	Ø 4 3/4"
cl. 35	oz. 11 7/8

772



mm. 0,8 Molla per ghiaccio  
Ice tongs  
Pince à glaçon  
Eiszange  
Pinzas hielo  
Lungh. cm. 15,5  
Length 6 1/8"

778



mm. 2,0 Molla per ghiaccio  
Ice tongs  
Pince à glaçon  
Eiszange  
Pinzas hielo  
Lungh. cm. 18  
Length 7 1/8"

382

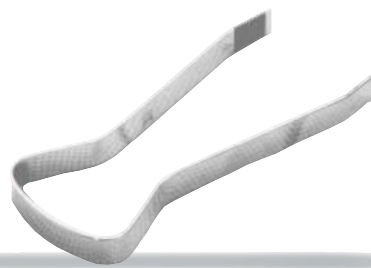

mm. 2,0 ERGONOMICA  
Molla per ghiaccio  
Ice tongs  
Pince à glaçon  
Eiszange  
Pinzas hielo  
Lungh. cm. 17  
Length 6 5/8"

774



mm. 0,8 Molla per dolci  
Pastry tongs  
Pince à gateaux  
Gebäckzange  
Pinzas dulces  
Lungh. cm. 19  
Length 7 1/2"

777



mm. 0,8 Molla per spaghetti  
Spaghetti/Pasta  
tongs  
Pince à spaghetti  
Spaghettizange  
Pinzas spaghetti  
Lungh. cm. 21  
Length 8 1/4"

775

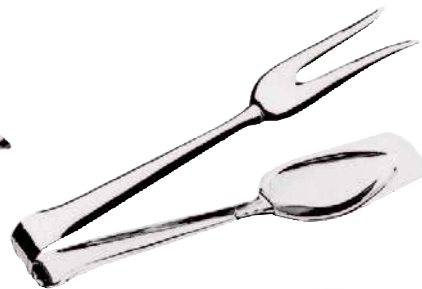

mm. 0,8 Molla per arrosto e verdure  
Roasts and vegetables tongs  
Pince à salade et à rôti  
Servierzange  
Pinzas asado y verduras  
Lungh. cm. 21  
Length 8 1/4"

779



mm. 0,8 Molla per lumache  
Escargot tongs  
Pince à escargots  
Schneckenzange  
Pinzas para caracoles  
Lungh. cm. 16  
Length 6 1/4"

771



mm. 0,8 Molla per zucchero  
Sugar tongs  
Pince à sucre  
Zuckerzange  
Pinzas azúcar  
Lungh. cm. 14  
Length 5 1/2"

752

741



mm. 0,8 Piattino per lumache Ø cm. 13,5-6pz. Ø 5 3/8" - 6pcs.  
Escargot dish Ø cm. 18 - 12pz. Ø 7 1/8" - 12pcs.  
Plat à escargots  
Schneckenplatte  
Plato caracoles

Molla per lumache Lungh. cm. 16 Length 6 1/4"  
Tongs for snails  
Pince à escargots  
Schneckenzange  
Pinzas para caracoles



mm. 0,8 Tegamino friggiuova Ø cm. 16 Ø 6 1/4"  
Frying pan for eggs  
Plat à oeuf  
Eierpfanne  
Plato huevos

904

911



mm. 1,2 Posacenere cm. 14 x 12 5 1/2" x 4 3/4"  
Ash-tray  
Cendrier  
Ascher  
Cenicero



mm. 0,6 Scodella lavadita Ø cm. 12 Ø 4 3/4"  
Finger bowl cl. 30 oz. 10 1/8  
Ecuelle  
Fingerbowl  
Lavadedos

956

528



mm. 1,2 Cloche copriburro o per antipasti Ø cm. 10,5 Ø 4 1/16"  
Cloche for hors d'oeuvre or butter plate Ø cm. 13 Ø 5 1/16"  
Cloche dome pour assiette  
Cloche für Vorspeisen- oder Butterteller  
Tapa para mantequera o para platos por entremes



mm. 1,2 Formaggera ODEON cl. 20 oz. 6 3/4  
Parmesan cheese basin »  
Fromagère »  
Käsedose »  
Quesera-Azucarero »

998



Ø mm 8,0 Portabottiglia  
Bottle stand  
Porte-bouteille  
Rotweinwiege  
Portabotella

H cm. 23 H 9"  
cm. 21 x 5,5 8 1/4" x 2 1/8"

711



mm. 0,6 Portauovo  
Egg-cup  
Coquetier  
Eierbecher  
Huevera

cm 15 x 9 5 7/8" x 3 1/2"

707



mm. 1,2 Portaburro  
Butter dish  
Beurrer  
Butterdose mit Deckel  
Mantequera  
cm. 11 x 20  
4 3/8" x 7 7/8"

799P



799W



799N



Ciotola quadra  
Square bowl  
Bol, carré  
Universalschale auf Holz, quadr.  
Cuenco cuadrado  
cm. 6 x 6  
2 3/8" x 2 3/8"

TRE  
"  
"  
"



mm. 1,2 Ciotola per antipasto UNO  
Snack bowl »  
Bol à snacks »  
Snackschale »  
Cuenco por entremes »  
Ø cm 9  
Ø 3 1/2"

544

504



Ø cm. 19  
H cm. 27  
Ø 7 1/2"  
H 10 5/8"

504



cm. 17,5 x 16,5  
H cm. 29,5  
6 7/8" x 6 1/2"  
H 11 3/5"

503



cm. 26 x 12  
H cm. 28,5  
10 1/4" x 4 3/4"  
H 11 1/5"

356



355

cm. 12 x 6  
H cm. 28,5

355

Ø mm. 6,0 Cestelli portacondimenti da tavola  
Basket for aromatic condiments  
Corbeilles pour condiments aromatiques  
Tisch-Essig/Öl Flaschenhalter  
Cestos para aromaticos y condimentos

mm. 1,2 Cestelli portacondimenti da buffet  
Basket for aromatic condiments  
Corbeilles pour condiments aromatiques  
Buffet-Essig/Öl Flaschenhalter  
Cestos para aromaticos y condimentos

4 3/4" x 2 1/3"  
H 11 1/5"

446

156

451

NEW



mm. 1,2	8 1/2 Portatoast Toast rack Porte-toast Toastständer Portatostadas	cm. 21 x 7,5 8 1/4" x 3"	mm. 1,2	Portatoast Toast rack Porte-toast Toastständer Portatostadas	cm. 21 x 7,5 8 1/4" x 3"	mm. 1,2	Portatoast Toast rack Porte-toast Toastständer Portatostadas	cm. 21 x 7,5 8 1/4" x 3"
---------	---	-----------------------------	---------	--	-----------------------------	---------	--	-----------------------------

903

85303

901



Segnaposto Table number stand Numéro de table Tischnummern-Aufsteller Numero de mesa mm. 0,6	cm 11 x 9 4 3/8" x 3 1/2"	Segnaposto Table number stand Numéro de table Tischnummern-Aufsteller Numero de mesa mm. 3,0	H cm. 8 cm 8 x 8 H 3 1/8" 3 1/8" x 3 1/8"	Portanumero Table number stand Numéro de table Tischnummern-Ständer Numero de mesa mm. 0,6	cm. 9,5 x 5 Ø cm.10 H cm 10 3 3/4" x 2" Ø 4" H 4"
---	------------------------------	---	--	---	--

289



289

mm.1,2  
Porta cono patatine GALA  
Chips cone holder "  
Porte pommes frites "  
Eis-Kartoffenbehälter "  
Porta cono patatas fritas "  
Ø cm.6 - H cm. 10  
Ø 2" - H 3 7/8"



726

mm.1,2  
Coppa Martini  
Martini Glass  
Verre à Martini  
Martini glas  
Vaso para Martini  
cl. 11 oz. 3 3/4  
cl. 20 oz. 6 3/4



727

mm.1,2  
Coppa per intermezzo  
Intermezzo cup  
Coupe à intermezzo  
Sorbeteschale  
Copa para intermezzo  
cl. 4  
oz. 1 3/8

152

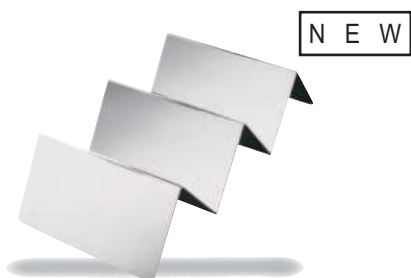

mm. 1,2 Porta tacos  
Tacos Holder  
Support pour tacos  
Tacoshalter  
Porta Tacos

cm 20 x 10 7 3/4" x 3 7/8"  
H cm 5 H 2"

314



mm. 1,2 Vassoio concavo ERGONOMICA  
Crescent tray »  
Plateau concave »  
Konkave Tablett »  
Bandeja concavo »

cm 40 x 19 15 3/4" x 7 1/2"  
cm 55 x 28 21 5/8" x 11"

232



mm. 1,2 Vassoio per self service  
Cafeteria tray  
Plateau pour self service  
Tablett für self service  
Bandeja para self service

cm. 40 x 30 15 3/4" x 11 7/8"

905

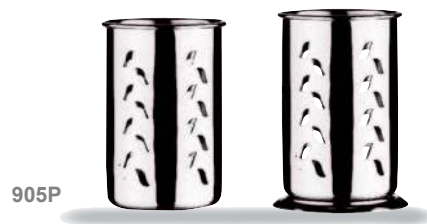

mm. 0,8 Portagrissini  
Bread sticks holder  
Porte gressin  
Grissini-Halter  
Porta bastoncillos de pan

Ø cm 10 Ø 3 7/8"  
H cm. 17 H 6 5/8"

675



mm. 0,8 Portabottiglia antirollio per yacht  
Yachting non-slip bottle holder  
Cache eau minerale avec anneau antiderapant  
Antiroll-Spezialflaschenhalter für Yachten  
Portabotella antibalanco para yacht

Ø cm. 10  
H cm. 17  
Ø 3 7/8"  
H 6 5/8"

496AC

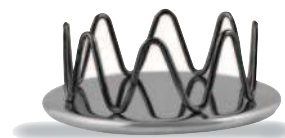

mm. 1,2 Salvagoccia bottiglia vino rosso  
Anti-drop wine bottle coaster  
Dessous de bouteille de vin  
anti-goutte  
Tropfen einflaschenuntersetzer  
Posabotella antigoteo por vino

Ø cm. 11,5 Ø 4 1/2"

229



mm. 1,2 Portasalse per fiorentina o tartara cl. 35 (x4) oz. 11<sup>7</sup>/<sub>8</sub> (x4)  
 Sauce set for Florentine or Tartar steak  
 Service à sauce pour Florentin ou Tartare  
 Sauce Set für Florentine oder Tartar Steak  
 Servicio para salsa por bistek Tartara y Florentina

230



mm. 1,2 Completo portasalse per fiorentina o tartara cm. 40 x 27 15<sup>3</sup>/<sub>4</sub>" x 10<sup>5</sup>/<sub>8</sub>"  
 Complete sauce set for Florentine or Tartar steak cl. 35 (x4) oz. 11<sup>7</sup>/<sub>8</sub> (x4)  
 Service à sauce complet pour Florentin ou Tartare  
 Sauce Set für Florentine oder Tartar Steak  
 Servicio para salsa por bistek Tartara y Florentina

094



mm. 1,2 Cestino rotondo CAMELLA Ø cm. 27 Ø 10<sup>5</sup>/<sub>8</sub>"  
 Round basket " "  
 Corbeille ronde " "  
 Obstschale, rund " "  
 Frutero redondo " "

098



mm. 1,2 Vassoio CAMELLA cm. 35 x 23 13<sup>3</sup>/<sub>4</sub>" x 9<sup>1</sup>/<sub>4</sub>"  
 Tray " " cm. 40 x 27 15<sup>3</sup>/<sub>4</sub>" x 10<sup>5</sup>/<sub>8</sub>"  
 Plateau " "  
 Tablett " "  
 Bandeja " "

721



mm. 1,2 Coppa termica con cloche Ø cm. 8,5 Ø 3<sup>1</sup>/<sub>3</sub>"  
 Insulated cup with cloche cl. 15 oz. 6  
 Coupe thermique avec cloche  
 Isolier-Eisfruchtbecher mit Deckel  
 Copa térmica con tapa

356



mm. 1,2 Cestello portacondimenti da buffet cm. 26 x 12  
 Basket for aromatic condiments H cm. 28,5  
 Corbeille pour condiments aromatiques  
 Buffet-Essig/Öl Flaschenhalter 10<sup>1</sup>/<sub>4</sub>" x 4<sup>3</sup>/<sub>4</sub>"  
 Cesto para aromáticos y condimentos" H 11<sup>1</sup>/<sub>5</sub>"

280



mm. 1,2	Set per ceviche in acciaio inossidabile 18/10	<b>607</b>	<b>607</b>
	18/10 Stainless Steel ceviche set	Ø cm. 27	Ø 10 1/2"
	Set pour ceviche en acier inoxydable 18/10	H cm. 13,5	H 5 1/4"
	Cevicheset in Rostfreie Stahl 18/10	lt. 5	gal. 1 1/3
	Cevichera en acero inoxidable 18/10	<b>58922</b>	<b>58922</b>
		Ø cm. 22	Ø 8 1/2"
		H cm. 14	H 5 1/2"
		cl. 220	oz. 74 3/8

281



mm. 1,2	Set per ceviche in policarbonato	<b>58928</b>	<b>58928</b>
	Polycarbonate ceviche set	Ø cm. 28	Ø 11"
	Set pour ceviche en polycarbonate	H cm. 17,3	H 6 5/8"
	Cevicheset in Polikarbonat	lt. 6,03	oz. 202 1/2
	Cevichera en policarbonado	<b>58922</b>	<b>58922</b>
		Ø cm. 22	Ø 8 1/2"
		H cm. 14	H 5 1/2"
		cl. 220	oz. 74 3/8

994C



mm. 1,2	Portanumero piccolo	H cm. 7	H 2 3/4"
	Mini table number stand		
	Numbers etched to order		
	Mini marquer de table		
	Mini Tischnummernständer		
	Porta numero de mesa pequeño		

913



mm. 1,0	Porta badge in acciaio magnetico	cm. 8 x 4,5	3 1/7" x 1 3/4"
	Badge holder in magnetic steel		
	Porte-badge en acier magnétique		
	Badge-Halter in magnetischem Stahl		
	Porta tarjeta de acero magnético		

225



Cloche trasparente	Ø cm. 12	Ø 4 3/4"
Transparent cloche	Ø cm. 22	Ø 8 1/2"
Cloche transparente	Ø cm. 28	Ø 11"
Transparent Tellercloche		
Tapa transparente		

709



mm. 1,2	Portastuzzicadenti con base	Ø cm. 4	Ø 1 1/2"
	Toothpick container with base	H cm. 5,8	H 2 1/4"
	Porte-cure-dents avec socle	cl. 5	oz. 1 3/4
	Zahnstocherbehälter auf Fuss		
	Porta-palillos con base		

047



Colino da cocktail  
Cocktail strainer  
Passoire à cocktail  
Cocktailsieb  
Colador para coctelera

cm. 22 8 2/3"

049



Cavatappi  
Cork screw / Bottle opener  
Ouvre boîte - Ouvre-bouteilles  
Korkenzieher  
Abrebotellas

H cm. 19 H 7 1/2"

025



Grattugia  
Grater  
Râpe  
Reibe  
Rallador

cm. 23 9"

048

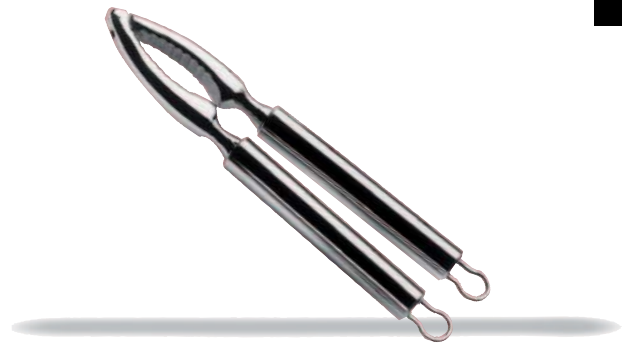

Schiaccianoci  
Nutcracker  
Casse noix  
Nussknacker  
Rompenueces

cm. 20 7 7/8"

473



ATTILA  
Cavatappi  
Cork screw / Bottle opener  
Décapsuleur  
Korkenheber  
Abrebotellas

cm. 10 3 7/8"

mm. 1,2

10001108



Cucchiaino per caviale  
Caviar spoon  
Cuillère à caviar  
Kaviarlöffel  
Cucharita caviar

cm. 11,8 4 2/3"

447



JOKER  
Macinapepe  
Pepper mill  
Moulin à poivre  
Pfeffermühle  
Molinillo de pimienta

Ø cm. 4    Ø 1 1/2"  
H cm. 15    H 5 7/8"

464



ETNA  
Macinasale  
Salt mill  
Moulin à sel  
Salzmühle  
Molinillo de sal

Ø cm. 4    Ø 1 1/2"  
H cm. 15    H 5 7/8"

466



MANOLO  
Macinapeperoncino  
Chilli mill  
Moulin à piment  
Chilimühle  
Molinillo de chile

Ø cm. 4    Ø 1 1/2"  
H cm. 15    H 5 7/8"

462



PARDON  
Tagliatartufi  
Truffles slicer  
Coupe truffes  
Trüffel Hobel  
Cortador de trufas

cm. 20 x 8    7 7/8" x 3 1/7"

104



mm. 1,2 EPOQUE  
Sottopiatto e Sottobottiglia  
Charger and Bottle coaster  
Assiette de bienvenue et  
Dessous de bouteille  
Platz- und Flaschenteller  
Bajo plato y Posabotella

Ø cm. 34    Ø 13 3/8"  
Ø cm. 14,5    Ø 5 3/4"

133

671



mm. 1,0 Vasetto portafiori    H. cm. 14    H. 5 1/2"  
Flower vase  
Vase à fleur  
Blumenvase  
Florero

757



mm. 1,2 ORCHIDEA  
 Appoggia borse  
 Bags support  
 Soutier de sacs  
 Beutelstand  
 Apoya bolsas

cm. 30 x 40 11 7/8" x 15  
 H cm. 30 3/4"

758



mm. 1,2 PEONIA  
 Appoggia borse  
 Bags support  
 Soutier de sacs  
 Beutelstand  
 Apoya bolsas

cm. 37 x 31 14 5/8" x 12  
 H cm. 33 1/4"

755



mm. 1,2 IRIS  
 Appoggia borse  
 Bags support  
 Soutier de sacs  
 Beutelstand  
 Apoya bolsas

Ø cm. 35 13 3/4"  
 H cm. 38 H 15"

756



mm. 1,2 BIANCOSPINO  
 Appoggia borse  
 Bags support  
 Soutier de sacs  
 Beutelstand  
 Apoya bolsas

Ø cm. 37 14 5/8"  
 H cm. 37 H 14 5/8"





# Tea Time

94003

976S



mm. 1,2 Servizio per zucchero  
Sugar set  
Service pour sucre  
Zucker Menage  
Juego azucar

cl. 15 (x3) oz. 5 1/8 (x3)  
cl. 15 (x4) oz. 5 1/8 (x4)

mm. 1,2 Portasalatini impilabile  
Stackable snack server  
Support à snack empilable  
Stapelbare Relish-Pickles-Gestell  
Servicio por entremes impilable

Ø cm. 20 Ø 7 7/8"  
cl. 15 (x3) oz. 5 1/8 (x3)

**976C** Ø cm. 20 Ø 7 7/8"  
H cm 15 H 5 7/8"  
cl. 15 (x3) oz. 5 1/8 (x3)

984

974

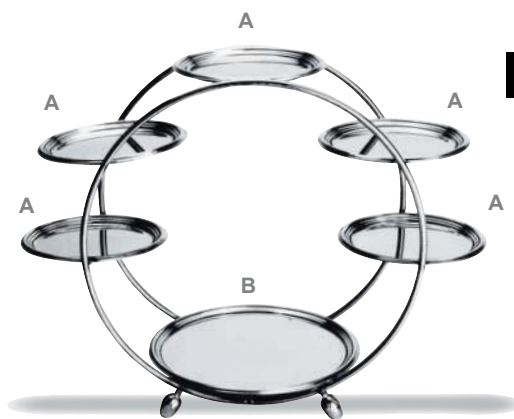
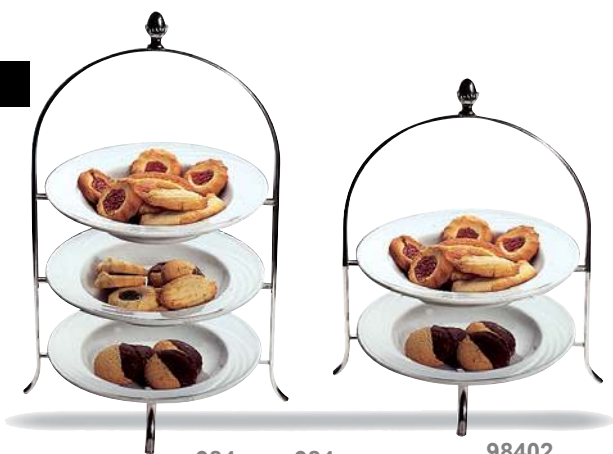

Alzata portapiatti  
Afternoon tea stand  
Présentoir à gateau  
Dessert-Serviergestell  
Soporte platos

**984** Ø cm 22 Ø 8 3/16"  
H.cm.45 H 17 1/4"  
**985** Ø cm 18 Ø 7 1/8"  
H.cm.33 H 13"  
**989** Ø cm 30 Ø 11 3/4"  
H.cm.52 H 20 1/2"

**98402** Ø cm 22 Ø 8 3/16"  
H cm.35 H 13 3/4"

mm. 1,2 Presentoir  
2 misure  
2 sizes  
2 tailles  
2 Größen  
2 tamaños

**A** Ø cm.13 (x5) A Ø 5 1/8" (x5)  
**B** Ø cm.19 B Ø 7 1/2"

**A** Ø cm.19 (x5) A Ø 7 1/2" (x5)  
**B** Ø cm.27 B Ø 10 5/8"



257



Porta pasticcini c/pied.  
Petit-fours stand with base  
Porte-petits-fours a/socle  
Petits Fours-Ständer  
Porta dulces con pedestal

mm. 1,2

Ø cm. 14    Ø 5 1/2"  
Hcm. 8,7    H 3 1/2"

Ø cm. 20    Ø 7 7/8"  
Hcm. 13    H 5 1/8"

Ø cm. 28    Ø 11"  
Hcm. 14,5    H 5 3/4"

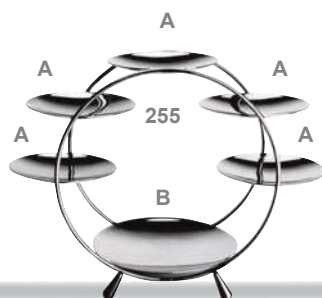

Presentoire  
2 mesure  
2 sizes  
2 tailles  
2 Größen  
2 tamaños  
mm. 1,2

**25506**  
A Ø cm.6 (x5)  
B Ø cm.7,5  
H cm. 13

**25508**  
A Ø cm.7,5 (x5)  
B Ø cm.11  
H cm. 17

**25506**  
A Ø 2 2/5" (x5)  
B Ø 3"  
H 5 1/8"

**25508**  
A Ø 3" (x5)  
B Ø 4 1/3"  
H 6 5/8"

258



Porta pasticcini c/pied.  
Petit-fours stand w/base  
Porte-petits-fours a/socle  
Petits Fours-Ständer  
Porta dulces c/pedestal

mm. 1,2

Ø cm. 14  
Ø cm. 20  
Ø cm. 28  
H cm. 27

Ø 5 1/2"  
Ø 7 7/8"  
Ø 11"  
H 10 5/8"

721



Coppa termica con cloche  
Insulated cup with cloche  
Coupe thermique avec cloche  
Isolier-Eisfruchtbecher mit Deckel  
Copa térmica con tapa

mm. 1,2

Ø cm. 8,5  
cl. 15

Ø 3 3/4"  
oz. 5 1/8

451



Portatoast  
Toast rack  
Porte-toast  
Toastständer  
Portatostadas

cm. 21 x 7,5

8 1/4" x 3"

mm. 1,2



Porta macaron  
Macarons server  
Porte macarons  
Macaronsträger  
Porta macaron

mm. 1,2

Ø cm 15  
H cm 10

Ø 5 7/8"  
H 4"

935

702



Mini burriera con coperchio  
Small butter dish w/lid  
Petit beurrier a/couvercle  
Mini Butterdose m/Deckel  
Platillo para mantequilla c/tapa

mm. 1,2

cm. 12 x 6  
cl. 15

4 3/4" x 2 1/3"  
oz. 5 1/8

526



Vassoio rett. a 4 comp.  
Rectang. tray 4 comp.  
Plateau rect. ou 4 plac.  
Tablett, rech. 4 Eins.  
Bandeja rect. 4 posic.

mm. 1,2

cm. 23 x 13

9" x 5 1/8"

524



Set cremiera Koji 5pz c/vass.  
Cream set Koji 5 pcs w/tray  
Set à crème Koji 5 pcs a/plat.  
Sahne Set 5-Tlg. Koji m/Tab.  
Servicio leche Koji 5pzs. c/band.

mm. 1,2

cm. 12 x 12  
cl. 25

4 3/4" x 4 3/4"  
oz. 8 2/5

52405

265



Vassoio per pasticceria  
Patisserie tray  
Plateau pour patisserie  
Patisserie Tablett  
Bandeja para pasteleria

cm. 24,5 x 17  
cm. 30 x 21  
cm. 34 x 24

9 5/8" x 6 3/4"  
11 3/4" x 8 1/4"  
13 3/8" x 9 1/2"

mm. 1,2

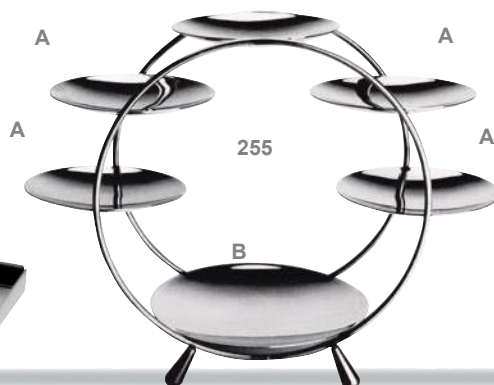

Presentoire  
3 misure  
3 sizes  
3 tailles  
3 Größen  
3 tamaños

mm. 1,2

**25514**  
A Ø cm.14 (x5)  
B Ø cm.20  
H cm. 30

**25520**  
A Ø cm.20 (x5)  
B Ø cm.24  
H cm. 30

**25524**  
A Ø cm.24 (x5)  
B Ø cm.28  
H cm. 41

**25514**  
A Ø 5 1/2" (x5)  
B Ø 7 7/8" (x5)  
H 11 3/4"

**25520**  
A Ø 7 7/8" (x5)  
B Ø 9 1/2" (x5)  
H 11 3/4"

**25524**  
A Ø 9 1/2" (x5)  
B Ø 11" (x5)  
H 16 3/5"

205



Vassoio per pasticceria con piedistallo  
Patisserie tray with foot  
Plateau pour patisserie avec socle  
Patisserie Tablett mit Fuss  
Bandeja para pasteleria con pies

cm. 26 x 12  
cm. 60 x 12  
H cm. 13

10 1/4" x 4 3/4"  
23 3/5" x 10 1/5"  
H 5 1/9"

mm. 1,2

206



Vassoio per pasticceria  
Patisserie tray  
Plateau pour patisserie  
Patisserie Tablett  
Bandeja para pasteleria

cm. 26 x 12  
cm. 60 x 12

10 1/4" x 4 3/4"  
23 3/5" x 10 1/5"

mm. 1,2

516



Portabustine da zucchero  
Sugar packet holder  
Pot à sucre  
Zuckerstangengefäß  
Azucarera

mm. 1,2

51610



**516**  
cm. 10 x 7  
H cm. 3

**516**  
4" x 2 3/4"  
H 1 1/8"

**51610**  
cm. 10 x 5  
H cm. 4,5

**51610**  
4" x 2"  
H 1 3/4"

704



Portatovaglioli  
Napkin holder  
Distributeur de serviettes  
Serviettenhalter  
Portaservilletas

cm. 13 x 13

5 1/9" x 5 1/9"

mm. 1,2





# Caffè

621



mm. 1,2	Caffettiera con piedistallo	Tazze	1	cl. 15	5 1/8 oz.
	Coffee pot with base	Cups	2	cl. 27	9 1/8 oz.
	Cafetière avec socle	Bols	4	cl. 37	12 1/2 oz.
	Kaffeekanne auf Fuss	Tassen	6	cl. 55	18 1/8 oz.
	Cafetera con pedestal	Tazas	8	cl. 85	28 1/4 oz.
			10	cl. 110	37 1/4 oz.
			12	cl. 150	50 1/4 oz.
		16	cl. 200	67 1/8 oz.	

622



mm. 1,2	Teiera con piedistallo	Tazze	2	cl. 35	11 7/8 oz.
	Tea pot with base	Cups	4	cl. 50	16 7/8 oz.
	Théière avec socle	Bols	6	cl. 70	23 1/8 oz.
	Teekanne auf Fuss	Tassen	8	cl. 95	32 1/8 oz.
	Tetera con pedestal	Tazas	10	cl. 120	40 7/8 oz.

623



mm. 1,2	Lattiera con piedistallo	Tazze	1	cl. 15	5 1/8 oz.
	Milk jug with base	Cups	2	cl. 27	9 1/8 oz.
	Pot à lait avec socle	Bols	4	cl. 37	12 1/2 oz.
	Milchkanne auf Fuss	Tassen	6	cl. 55	18 1/8 oz.
	Jarra lechera con pedestal	Tazas	8	cl. 85	28 1/4 oz.
			10	cl. 110	37 1/4 oz.
			12	cl. 150	50 1/4 oz.
		16	cl. 200	67 1/8 oz.	

624



mm. 1,2	Zuccheriera con piedistallo	Tazze	2	cl. 15	5 1/8 oz.
	Sugar bowl with base	Cups	4	cl. 20	6 3/4 oz.
	Sucrier avec socle	Bols	6	cl. 27	9 1/8 oz.
	Zuckerdose auf Fuss	Tassen	8	cl. 35	11 1/8 oz.
	Azucarero con pedestal	Tazas			



624P

646



mm. 1,2	Caffettiera termica con piedistallo	Tazze	4	cl. 30	10 1/8 oz.
	Insulated coffee pot with base	Cups	6	cl. 60	20 1/4 oz.
	Cafetière thermique avec socle	Bols	12	cl. 150	50 1/4 oz.
	Isolier-Kaffeekanne auf Fuß	Tassen			
	Cafetera térmica con pedestal	Tazas			

648



mm. 1,2	Caraffa termica c/fermaghiaccio e piedistallo			cl. 150
	Insulated water pitcher w/ice-trap and base			
	Carafe à eau avec attrape-glace et socle			
	Isolier-Wasserkrug auf Fuss			50 1/4 oz.
	Jarra agua c/tope y pedestal			

641



mm. 1,2	Caffettiera	Tazze	1	cl. 15	5 1/8 oz.
	Coffee pot	Cups	2	cl. 27	9 1/8 oz.
	Cafetière	Bols	4	cl. 37	12 1/2 oz.
	Kaffeekanne	Tassen	6	cl. 55	18 5/8 oz.
	Cafetera	Tazas	8	cl. 85	28 3/4 oz.
			10	cl. 110	37 1/4 oz.
			12	cl. 150	50 3/4 oz.
			16	cl. 200	67 5/8 oz.

642



mm. 1,2	Teiera	Tazze	1	cl. 20	6 1/4 oz.
	Tea pot	Cups	2	cl. 35	11 1/8 oz.
	Théière	Bols	4	cl. 50	16 1/8 oz.
	Teekanne	Tassen	6	cl. 70	23 5/8 oz.
	Tetera	Tazas	8	cl. 95	32 1/8 oz.
			10	cl. 120	40 5/8 oz.

643



mm. 1,2	Lattiera	Tazze	1/2	cl. 10	3 5/8 oz.
	Milk jug	Cups	1	cl. 15	5 1/8 oz.
	Pot à lait	Bols	2	cl. 27	9 1/8 oz.
	Milchkanne	Tassen	4	cl. 37	12 1/2 oz.
	Jarra lechera	Tazas	6	cl. 55	18 5/8 oz.
			8	cl. 85	28 3/4 oz.
			10	cl. 110	37 1/4 oz.
			12	cl. 150	50 3/4 oz.
			16	cl. 200	67 5/8 oz.

644



644P

mm. 1,2	Zuccheriera	Tazze	2	cl. 15	5 1/8 oz.
	Sugar bowl	Cups	4	cl. 20	6 1/4 oz.
	Sucrier	Bols	6	cl. 27	9 1/8 oz.
	Zuckerdose	Tassen	8	cl. 35	11 1/8 oz.
	Azucarero	Tazas			

647



mm. 1,2	Caraffa termica per acqua c/fermaghiaccio	cl. 150
	Insulated water pitcher w/ice-trap	
	Carafe à eau avec attrape-glace	
	Isolier-Wasserkrug	50 1/4 oz.
	Jarra agua c/tope	

645



mm. 1,2	Caffettiera termica	Tazze	4	cl. 30	10 1/8 oz.
	Insulated coffee pot	Cups	6	cl. 60	20 1/4 oz.
	Cafetière thermique	Bols	12	cl. 150	50 1/4 oz.
	Isolier-Kaffeekanne	Tassen			
	Cafetera térmica	Tazas			

940



940E  
 Inserto per art. 940  
 Insert for art. 940  
 Insért pour art. 940  
 Einsatz für Art. 940  
 Inserto por art. 940

940E



94005



mm. 1,2 Servizio per caffè macchiato  
 Café au lait set  
 Service pour café au lait  
 Café au lait-Set  
 Juego café au lait

939  
 H cm 18  
 cl. 90

939  
 H 7 1/8"  
 oz. 30 1/2

940  
 H cm 18  
 cl. 97

940  
 H 7 1/8"  
 oz. 32 7/8

mm. 1,2 Servizio per caffè macchiato  
 5pcs Sugar, milk and coffee set  
 Service sucre, lait et café 5 pièces  
 Milch-Kaffee-Zucker Set 5-Tlg.  
 Juego leche, café y azucar 5 piezas

H cm 18 H 7 1/8"  
 cl. 30 (x5) oz. 10 1/8 (x5)

94003



mm. 1,2 Servizio per zucchero 3 pezzi  
 Sugar set 3 pcs.  
 Service pour sucre 3 pièces  
 Zucker Menage 3-Tlg  
 Juego azucar 3 piezas

cl. 11 (x3) oz. 3 3/4 (x3)

94004



mm. 1,2 Servizio per zucchero 4 pezzi  
 Sugar set 4 pcs.  
 Service pour sucre 4 pièces  
 Sahne-/Zucker-Set 4-Tlg  
 Juego azucar 4 piezas

cl. 11 (x4) oz. 3 3/4 (x4)

649



mm. 1,2 Bricco  
 Jug  
 Cruche  
 Milchkännchen  
 Jarra

BOMBATA cl. 20

oz. 6 3/4

639



mm. 1,2 Bricco  
 Jug  
 Cruche  
 Milchkännchen  
 Jarra

BOMBATA cl. 20

oz. 6 3/4

631



mm. 1,2

Caffettiera  
Coffee pot  
Cafetière  
Kaffeekanne  
Cafetera

Tazze	2 cl. 24	8 1/8 oz.
Cups	4 cl. 34	11 1/2 oz.
Bols	6 cl. 46	15 1/2 oz.
Tassen	8 cl. 63	21 1/8 oz.
Tazas	10 cl. 100	33 3/8 oz.
	12 cl. 150	50 1/4 oz.
	16 cl. 200	67 1/8 oz.

632



mm. 1,2

Teiera  
Tea pot  
Théière  
Teekanne  
Tetera

Tazze	2 cl. 40	13 1/2 oz.
Cups	4 cl. 50	16 1/8 oz.
Bols	6 cl. 68	23 oz.
Tassen	8 cl. 90	30 1/2 oz.
Tazas		

633



mm. 1,2

Lattiera  
Milk jug  
Pot à lait  
Milchkanne  
Jarra lechera

Tazze	1 cl. 10	3 1/8 oz.
Cups	2 cl. 24	8 1/8 oz.
Bols	4 cl. 34	11 1/2 oz.
Tassen	6 cl. 46	15 1/2 oz.
Tazas	8 cl. 63	21 1/4 oz.
	10 cl. 100	33 3/8 oz.
	12 cl. 150	50 1/4 oz.
	16 cl. 200	67 1/8 oz.

634



mm. 1,2

Zuccheriera  
Sugar bowl  
Sucrier  
Zuckerdose  
Azucarero

Tazze	4 cl. 15	5 1/8 oz.
Cups	6 cl. 22	7 1/2 oz.
Bols	8 cl. 28	9 1/2 oz.
Tassen		
Tazas		

635



mm. 1,2

Brocca per acqua con fermagliaccio  
Water pitcher with ice-trap  
Carafe à eau avec attrape-glace  
Eiswaserkrug  
Jarra agua c/topo

cl. 100  
cl. 200

33 1/5 oz.  
67 1/3 oz.

651



mm. 1,2

Caffettiera  
Coffee pot  
Cafetière  
Kaffeekanne  
Cafetera

Tazze	2	cl. 25	8 1/2 oz.
Cups	4	cl. 37	12 1/2 oz.
Bols	6	cl. 52	17 1/8 oz.
Tassen	8	cl. 70	23 1/8 oz.
Tazas	10	cl. 100	33 1/8 oz.
	12	cl. 150	50 1/4 oz.
	16	cl. 200	67 1/8 oz.

652



mm. 1,2

Teiera  
Tea pot  
Théière  
Teekanne  
Tetera

Tazze	2	cl. 40	13 1/2 oz.
Cups	4	cl. 55	18 1/8 oz.
Bols	6	cl. 70	23 1/8 oz.
Tassen	8	cl. 97	32 1/4 oz.
Tazas			

653



mm. 1,2

Lattiera  
Milk jug  
Pot à lait  
Milchkanne  
Jarra lechera

Tazze	1	cl. 10	3 1/8 oz.
Cups	2	cl. 25	8 1/2 oz.
Bols	4	cl. 37	12 1/2 oz.
Tassen	6	cl. 52	17 1/8 oz.
Tazas	8	cl. 70	23 1/8 oz.
	10	cl. 100	33 1/8 oz.
	12	cl. 150	50 1/4 oz.
	16	cl. 200	67 1/8 oz.

654



mm. 1,2

Zuccheriera  
Sugar bowl  
Sucrier  
Zuckerdose  
Azucarero

Tazze	2	cl. 13	4 1/8 oz.
Cups	4	cl. 18	6 1/8 oz.
Bols	6	cl. 22	7 1/2 oz.
Tassen	8	cl. 30	10 1/8 oz.
Tazas			

361



mm. 1,2  
Caffettiera  
Coffee pot  
Cafetière  
Kaffeekanne  
Cafetera

Tazze	1	cl. 10	3 7/8 oz.
Cups	4	cl. 34	11 1/2 oz.
Bols	6	cl. 50	16 7/8 oz.
Tassen	8	cl. 75	25 3/8 oz.
Tazas	10	cl. 97	32 1/5 oz.
	16	cl. 200	67 7/8 oz.

362



mm. 1,2  
Teiera  
Tea pot  
Théière  
Teekanne  
Tetera

Tazze	2	cl. 35	11 7/8 oz.
Cups	4	cl. 50	16 7/8 oz.
Bols	6	cl. 75	25 3/8 oz.
Tassen	8	cl. 97	32 1/5 oz.
Tazas			

363



mm. 1,2  
Lattiera  
Milk jug  
Pot à lait  
Milchkanne  
Jarra lechera

Tazze	1	cl. 10	3 7/8 oz.
Cups	4	cl. 34	11 1/2 oz.
Bols	6	cl. 52	17 7/8 oz.
Tassen	8	cl. 75	25 3/8 oz.
Tazas	16	cl. 200	67 7/8 oz.

364



mm. 1,2  
Zuccheriera porta bustine  
Sugar packets holder  
Sucrier à sachets  
Zuckerdose/Zuckerstangengefäß  
Azucarera

<b>364T</b>	cl. 22	7 1/2 oz.
<b>364A</b>	cl. 22	7 1/2 oz.
<b>364B</b>	cl. 10	3 7/8 oz.

366



mm. 1,2  
Caffettiera termica  
Insulated coffee pot  
Cafetière thermique  
Isolier-Kaffeekanne  
Cafetera térmica

Tazze	6	cl. 50
Cups	8	cl. 75
Bols		
Tassen		16 7/8 oz.
Tazas		25 3/8 oz.

367



mm. 1,2  
Teiera termica  
Insulated tea pot  
Théière thermique  
Isolier-Teekanne  
Tetera térmica

Tazze	4	cl. 50
Cups	6	cl. 75
Bols		
Tassen		16 7/8 oz.
Tazas		25 3/8 oz.



516



mm. 1,2 Portabustine da zucchero  
Sugar packet holder  
Pot à sucre  
Zuckerstangengefäß  
Azucarera

cm. 10 x 7 4" x 2 3/4"  
H cm. 3 H 1 1/8"

206



mm. 1,2 Vassoio per pasticceria  
Pâtisserie tray  
Plateau pour pâtisserie  
Pâtisserie Tablett  
Bandeja para pasteleria

cm. 26 x 12 10 1/4" x 4 3/4"  
cm. 60 x 12 23 3/5" x 10 1/5"

136



mm. 1,2 Vassoio CAFE' VIENNA cm. 26 x 19 10 1/4" x 7 1/2"  
Tray »  
Plateau »  
Kaffeetablett »  
Bandeja »

704



mm. 1,2 Portatovaglioli  
Napkin holder  
Distributeur de serviettes  
Serviettenhalter  
Portaservilletas

cm. 13 x 13 5 1/9" x 5 1/9"

902



mm. 1,2 Portabastoncini da zucchero  
Sugar bags holder  
Pot à sucre  
Zuckerstangengefäß  
Azucarera

Ø cm 7 H 3 1/4"  
H cm 8 Ø 2 3/4"  
cl. 37 oz. 12 1/2

700



mm. 1,2 Zuccheriera  
Sugar container  
Sucriere  
Zuckerdose  
Azucarero

Ø cm 10 Ø 4"  
cl.35 oz 11 1/8

594



mm. 1,2    Cremlera con piedistallo UNO    cl.16    oz. 5<sup>3</sup>/<sub>8</sub>  
 Cream jug with base    »  
 Crémier avec socle    »  
 Sahnegießer/Milchkännchen    »  
 Jarrita lechera con pedestal    »

595



mm. 1,2    Zuccheriera con piedistallo UNO    cl. 24    oz. 8<sup>1</sup>/<sub>8</sub>  
 Sugar bowl with base    »  
 Sucrier avec socle    »  
 Zuckerdose auf Fuss    »  
 Azucarero con pedestal    »

499



mm. 1,2    MINIMA    cm.15 x 11    5<sup>1</sup>/<sub>8</sub>" x 4<sup>3</sup>/<sub>8</sub>"  
 Portabustine da zucchero 4 sc.    H.cm.14    H. 5<sup>1</sup>/<sub>2</sub>"  
 Sugar packets holder 4 compt.  
 Pot à sucre 4 comp.  
 Zuckerstangengefäß 4 Eins.  
 Azucarera 4 comp.

706



mm. 1,2    Porta salviette lavamani    cm. 15 x 9    5<sup>7</sup>/<sub>8</sub>" x 3<sup>1</sup>/<sub>2</sub>"  
 Tray for hand towels  
 Plateau porte serviettes  
 Tablett für Stoffservietten  
 Bandeja portaservilletas

703



10201144  
 Lungh. cm. 16,5  
 Length 6<sup>1</sup>/<sub>2</sub>"

mm.1,2    Set per latte macchiato    Ø cm. 10    Ø 3<sup>7</sup>/<sub>8</sub>"  
 Latte Macchiato Set    cl. 36    oz. 12<sup>3</sup>/<sub>8</sub>  
 Service pour Latte Macchiato  
 Latte Macchiato-Set  
 Servicio para café con leche

720



mm. 1,2    Portaburro e marmellata    cm. 17,5 x 7,5    6<sup>7</sup>/<sub>8</sub>" x 3"  
 Butter and jam dish  
 Beurre et confiture  
 Butter-Marmeladen-Platte  
 Porta mantequilla y mermelada

# Bar



941

661

665



Portacucchiaini per bar Ø cm. 9 Ø 3 1/4"  
Coffee spoons stand  
Pot à cuillères pour bar  
Löffelbecher  
Porta-cucharitas para bar  
mm. 0,8

Secchiello per spumante Ø cm. 18 Ø 7 1/4"  
Sparkling wine cooler H cm. 18,5 H 7 1/8"  
Seau à champagne lt. 4 gal. 1  
Wein-und Sektkühler  
Cubo para champany  
mm. 1,2

Secchiello per ghiaccio Ø cm. 13,5 Ø 5 1/8"  
Ice-bucket with knobs H cm. 13 H 5 1/8"  
Seau à glaçons cl. 150 oz. 50 1/4  
Eisgefäß  
Cubitera hielo  
mm. 0,8

708

545



mm. 1,2 Piattino portamonete  
Cash tray  
Plat à addition  
Zahlteller  
Bandeja porta monedas

cm. 11 x 15 4 1/8" x 5 1/8"

mm. 1,2 Dosatore  
Jigger  
Doseur  
Barmaß  
Medida

cl. 2 e 4 oz. 1  
oz. 1 1/8

Agitatore cl. 25 oz. 8 1/2  
Shaker cl. 50 oz. 16 1/8  
Shaker cl. 75 oz. 25 1/8  
Shaker  
Coctelera

729

551



mm. 1,2 Coppa per punch Ø cm. 38  
Punch bowl lt. 15  
Bol à punch  
Punchbowl Ø 15"  
Cazo ponche 4 gal.

Mestolo coppa per punch  
Punch bowl ladle  
Cuiller à punch  
Bowlenlöffel  
Cazo ponche

mm. 0,8

Agitatore Boston con bicchiere  
Boston shaker  
Boston shaker à cocktail et verre  
Boston Shaker  
Coctelera Boston

cl. 75 oz. 25 1/8

Colori disponibili a pag. 344  
Available colors at page 344  
Couleurs disponibles  
à page 344  
Sehen Sie erhaltlichen Farben  
an Seite 344  
Ver colores à pagina 344

972

973



972

973

973P

972P

mm. 1,2  
**972-972P**  
 PALACE  
 Secchiello per ghiaccio  
 Ice bucket  
 Seau à glaçons  
 Eisgefäß  
 Cubitera hielo

Ø cm 15    Ø 5 1/8"  
 H cm 18    H 7 1/8"  
 cl.150    oz. 50 3/4

mm. 1,2  
**973-973P**  
 PALACE  
 Secchiello per spumante  
 Sparkling wine cooler  
 Seau à champagne  
 Wein- und Sektkühler  
 Cubo para champany

Ø cm 20,5    Ø 8 1/8"  
 H cm 24,5    H 9 5/8"  
 lt. 5,0    gal. 1 1/3

666F

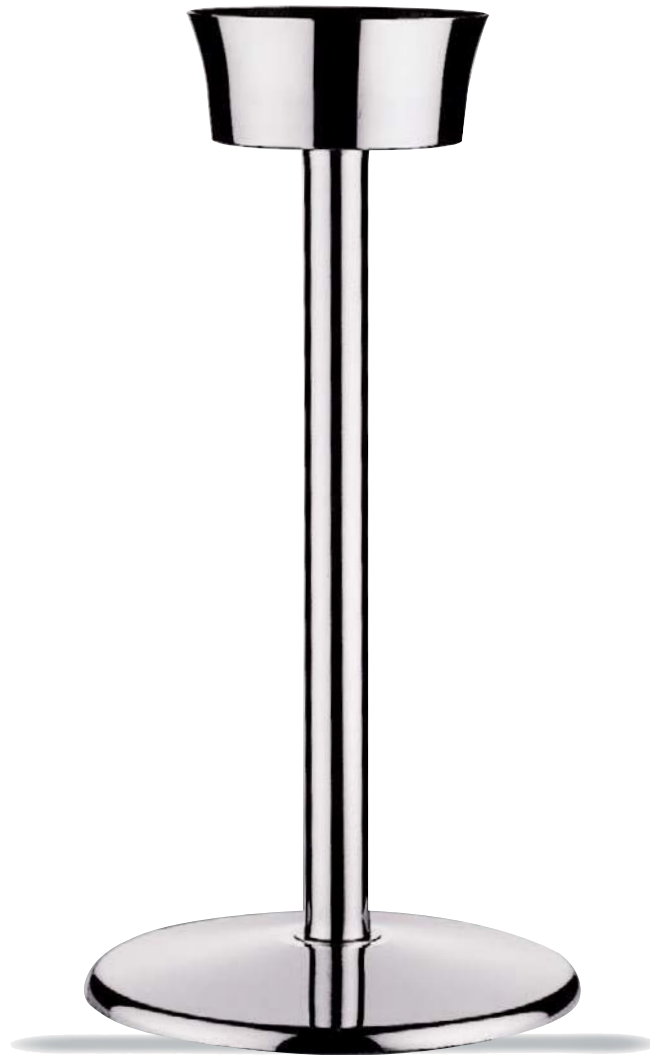

mm. 1,2  
**PALACE**  
 Colonna portasecchiello spumante  
 Wine cooler stand w/weighted base  
 Pied pour seau à champagne  
 Weinkühlerständer  
 Columna porta cubo champany

H cm. 67,5    H 26 5/8"

370



mm. 1,2 IMMAGINA  
 Secchiello per spumante  
 Sparkling wine cooler  
 Seau à champagne  
 Wein- und Sektkühler  
 Cubo para champany

cm 27 x 20,5  
 H cm 21,5  
 lt. 6,5

10 <sup>3</sup>/<sub>8</sub>" x 8"  
 H 8 <sup>1</sup>/<sub>2</sub>"  
 gal. 1 <sup>3</sup>/<sub>4</sub>

371



mm. 1,2 IMMAGINA  
 Secchiello per ghiaccio  
 Ice bucket  
 Seau à glaçons  
 Eisgefäß  
 Cubitera para hielo

cm 16,6 x 10  
 H cm 14,2  
 cl. 180

6 <sup>1</sup>/<sub>2</sub>" x 4"  
 H 8 <sup>1</sup>/<sub>2</sub>"  
 oz. 60 <sup>7</sup>/<sub>8</sub>

666H



mm. 1,2 IMMAGINA  
 Colonna portasecchiello spumante  
 Wine cooler stand  
 Pied pour seau à champagne  
 Weinkühlerständer  
 Columna porta cubo champany

H cm. 61,5 H 24 <sup>1</sup>/<sub>5</sub>"

670



**670 mm. 1,2**  
 Secchiello per ghiaccio  
 Ice bucket with grill  
 Seau à glaçons  
 Eisgefäß  
 Cubitera hielo  
 Ø cm.14 - H cm.13 - cl. 150  
 Ø 5 1/2" - H 5 1/8" - oz. 50 3/4



**662 mm. 1,2**  
 Rinfrescavino bianco da 1 bottiglia  
 White wine cooler for 1 bottle  
 Seau à vin blanc  
 Weissweinkühler für 1 Flasche  
 Cubo para refrescar 1 botella de vino blanco  
 Ø cm.16 - H cm.20 - lt. 3  
 Ø 6 1/4" - H 7 7/8" - oz. 101 1/2



**663 mm. 1,2**  
 Rinfrescavino spumante da 1 bottiglia  
 Sparkling wine cooler for 1 bottle  
 Seau à Champagne 1 bouteille  
 Champagnerkühler für 1 Flasche  
 Cubo para refrescar 1 botella de vino spum.  
 Ø cm.18 - H cm.21 - lt. 4,5  
 Ø 7 1/8" - H 8 1/4" - gal. 1 1/4



664

**664 mm. 1,2**  
 Rinfrescavino spumante da 2/3 bottiglie o Magnum  
 Sparkling wine cooler for 2/3 bottles or Magnum  
 Seau à champagne 2/3 bouteilles ou Magnum  
 Champagnerkühler für 2/3 Flaschen oder Magnum  
 Cubo para refrescar 2/3 botellas de vino spumante  
 Ø cm.22,5 - H cm.23 - lt. 8,5  
 Ø 8 7/8" - H 9" - gal. 2 1/4

666



mm. 1,2  
 Colonna portasecchiello spumante H cm. 65 H 25 5/8"  
 Wine cooler stand  
 Pied pour seau à champagne  
 Weinkühlerständer  
 Columna porta cubo champany

67704



mm. 0,8  
 Portaghiaccio termico con coperchio  
 Insulated ice-bucket with lid  
 Seau à glaçon thermique avec couvercle  
 Isolier-Eisgefäß  
 Cubitera hielo con tapa  
 lt. 3/4  
 lt. 4  
 oz. 25 3/8  
 gal. 1

676



mm. 0,8  
 Glacette termica per 1 bottiglia  
 Insulated glacette for 1 bottle  
 Glacette thermique pour 1 bouteille  
 Getränke Kühler 1 Flasche  
 Cubo térmico para 1 botella  
 Ø Int. cm. 10,3  
 Ø Est cm. 14,5  
 H cm. 21,5  
 cl. 150  
 Int. Ø 4"  
 Out. Ø 5 5/7"  
 H 8 3/5"  
 oz. 50 3/4

681

678



**681** mm.1,2  
MICHELANGELO  
Rinfrescavino spumante da 2/3 bottiglie o Magnum  
Sparkling wine cooler for 2/3 bottles or Magnum  
Seau à champagne 2/3 bouteilles ou Magnum  
Champagnerkühler für 2/3 Flaschen oder Magnum  
Cubo para refrescar 2/3 botellas de vino spumante  
Ø cm.22,5 - H cm.23 - lt. 8,5  
Ø 8 7/8" - H 9" - gal. 2 1/4

**680** mm.1,2  
MICHELANGELO  
Rinfrescavino spumante da 1 bottiglia  
Sparkling wine cooler for 1 bottle  
Seau à champagne 1 bouteille  
Champagnerkühler für 1 Flasche  
Cubo para refrescar 1 botella de vino spum.  
Ø cm.18 - H cm.21 - lt. 4,5  
Ø 7 1/8" - H 8 1/4" - gal. 1 1/4

**679** mm.1,2  
MICHELANGELO  
Rinfrescavino bianco da 1 bottiglia  
White wine cooler for 1 bottle  
Seau à vin blanc  
Weissweinkühler für 1 Flasche  
Cubo para refrescar 1 botella de vino blanco  
Ø cm.16 - H cm.20 - lt. 3  
Ø 6 1/4" - H 7 7/8" - oz. 10 1/2

**678** mm.1,2  
MICHELANGELO  
Secchiello per ghiaccio  
Ice bucket with grill  
Seau à glaçons  
Eisgefäß  
Cubitera hielo  
Ø cm.14 - H cm.13 - cl. 150  
Ø 5 1/2" - H 5 1/8" - oz. 50 3/4

672

666A



mm. 1,2 Portaggiaccio termico con anello e molla  
Insulated ice-bucket with handle and tongs for ice  
Seau à glaçon thermique avec anse et pinçe  
Isolier-Eisgefäß und Eiszange  
Cubitera hielo con asa y pinzas hielo

lt. 3/4 oz. 25 3/8

660



mm. 0,8 Servizio per champagne  
Insulated Champagne set  
Service pour champagne  
Champagnergetränkékühler  
Servicio para champagne

Ø cm. 26 Ø 10 1/4"  
H cm. 22 H 8 2/3"  
cl. 150 oz. 50 3/4

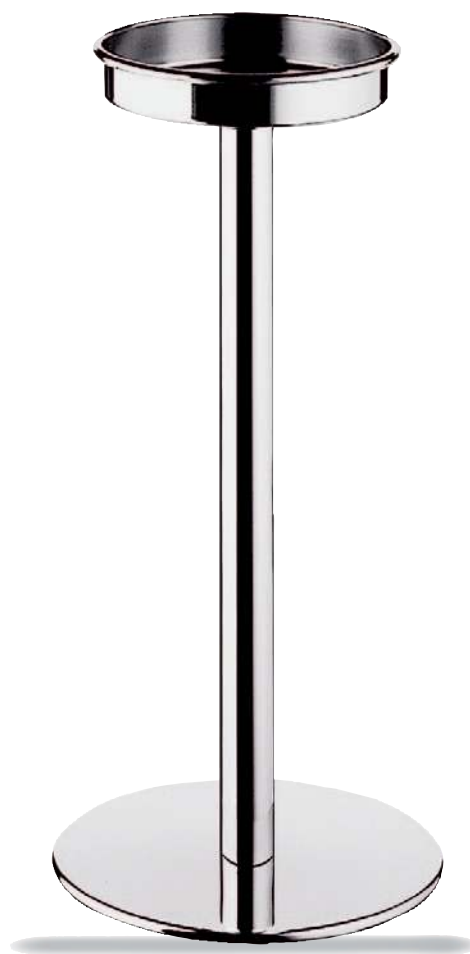

mm. 1,2 GALA  
Colonna portasecchiello spumante  
Wine cooler stand  
Pied pour seau à champagne  
Weinkühlerständer  
Columna porta cubo champany

H cm. 60 H 23 3/8"

67301



67304



mm. 1,2 GIOTTO  
Portaghiaccio termico con coperchio  
Insulated ice-bucket with lid  
Seau à glaçons thermique  
avec couvercle  
Isolier-Eisgefäß  
Cubitera hielo con tapa

Ø cm 14    Ø 5 1/2"  
H cm 13    H 5"  
cl.72        oz. 24 1/3

Ø cm 24    Ø 9 1/2"  
H cm 22    H 8 5/8"  
lt. 4,0      gal. 1

669



668

mm. 1,2 GIOTTO  
Secchiello spumante e ghiaccio  
Sparkling wine cooler / Ice bucket  
Seau à champagne et à glaçons  
Wein- Sektkühler / Eisgefäß  
Cubo para champany y para hielo

Ø cm 24    Ø 9 1/2"  
H cm 23    H 9"  
lt. 5,0      gal. 1 1/3

Ø cm 14,5    Ø 5 2/3"  
H cm 13      H 5 1/9"  
lt. 1,4        oz. 47 1/3

666E

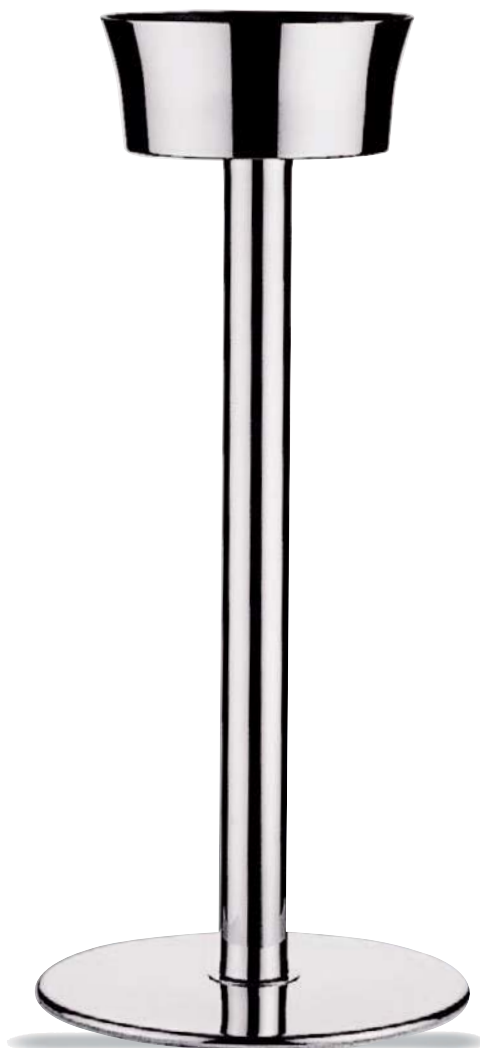

mm. 1,2 GIOTTO  
Colonna portasecchiello spumante  
Wine cooler stand  
Pied pour seau à champagne  
Weinkühlerstand  
Columna porta cubo champany

H cm. 67,5    H 26 5/8"

948



mm. 1,2 LESS IS MORE  
Rinfrescavino spumante da 3 bottiglie o 2 Magnum  
Sparkling wine cooler for 3 bottles or 2 Magnum  
Seau à champagne 3 bouteilles ou 2 Magnum  
Champagnerkühler für 3 Flaschen oder 2 Magnum  
Cubo para refrescar 3 botellas de vino spumante

cm. 35 x 15  
H cm. 18  
lt. 9

13 3/4" x 5 7/8"  
H 7 1/8"  
gal. 2 1/2

430



mm. 1,2 FASHION  
Rinfrescavino spumante da 2 bottiglie o Magnum  
Sparkling wine cooler for 2 bottles or Magnum  
Seau à champagne 2 bouteilles ou Magnum  
Champagnerkühler für 2 Flaschen oder Magnum  
Cubo para refrescar 2 botellas de vino spumante

H cm. 21  
cm. 21 x 21  
lt. 9

H 8 1/4"  
8 1/4" x 8 1/4"  
gal. 2 1/2

666M

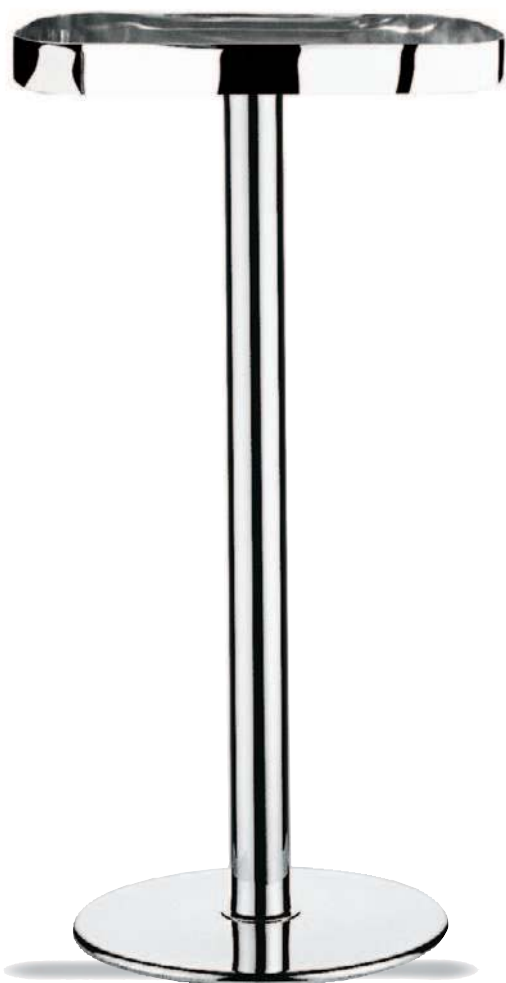

mm. 1,2 LESS IS MORE  
Colonna portasecchiello spumante  
Wine cooler stand  
Pied pour seau à champagne  
Weinkühlerständer  
Columna porta cubo champany

H cm. 62  
cm. 38 x 25

H 24 2/5"  
15" x 9 7/8"

666L

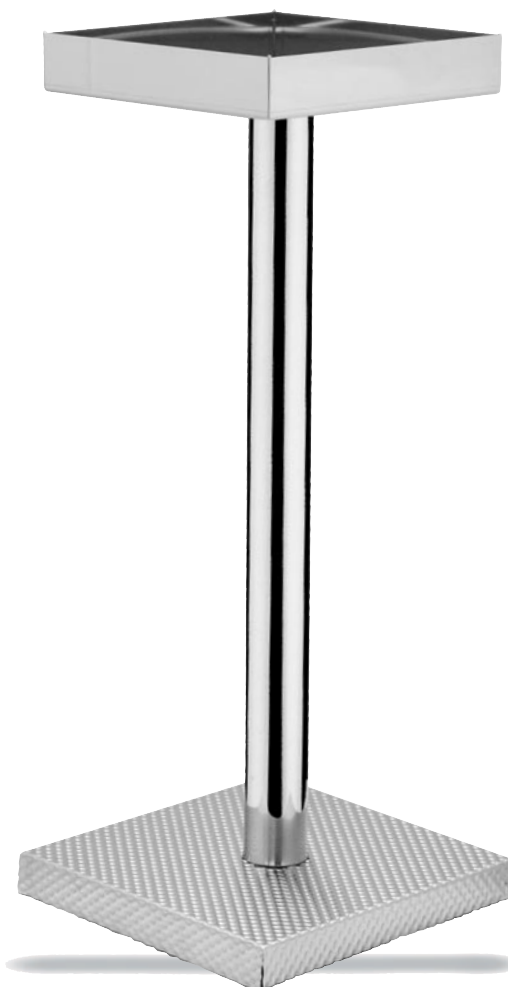

mm. 1,2 FASHION  
Colonna portasecchiello spumante  
Wine cooler stand  
Pied pour seau à champagne  
Weinkühlerständer  
Columna porta cubo champany

H cm. 61,5  
H 24 1/5"

597



mm. 1,2 UNO  
 Secchiello per ghiaccio  
 Ice bucket  
 Seau à glaçons  
 Eisgefäß  
 Cubitera hielo

Ø cm. 16,8    Ø 6 5/8"  
 H cm. 11     H 4 3/8"  
 cl. 150        oz. 50 3/4

598



mm. 1,2 UNO  
 Secchiello per spumante  
 Sparkling wine cooler  
 Seau à champagne  
 Wein- und Sektkühler  
 Cubo para champany

Ø cm. 29    Ø 11 3/8"  
 H cm. 18,5    H 7 1/4"  
 lt. 8            gal. 2

666W

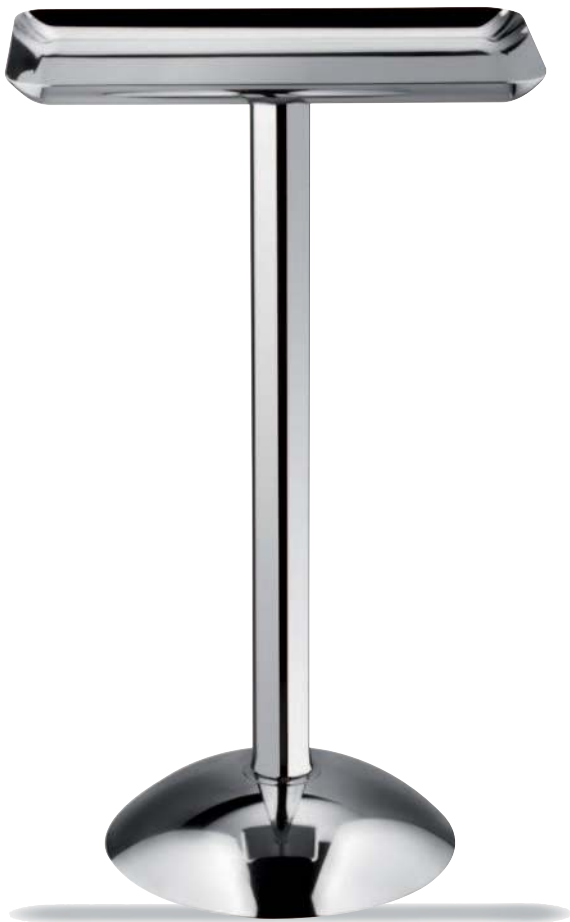

mm. 1,2 Gueridon d'appoggio rettangolare    H cm. 62    H 24 2/5"  
 Rectangular gueridon                    cm. 38 x 25    15" x 9 7/8"  
 But de canapé rectangulaire  
 Gueridon, rechteckig  
 Gueridon rectangular

666Z



mm. 1,2 Gueridon d'appoggio ovale    H cm. 62    H 24 2/5"  
 Oval gueridon                                cm. 46 x 31    18 1/8" x 12 1/4"  
 But de canapé oval  
 Gueridon, oval  
 Gueridon oval

599



mm. 1,2 UNO  
 Secchiello per spumante  
 Sparkling wine cooler  
 Seau à champagne  
 Wein- und Sektkühler  
 Cubo para champany

Ø cm. 29 Ø 11 3/8"  
 H cm. 18,5 H 7 1/4"  
 lt. 8 gal. 2

589



Ciotola tonda  
 Round bowl  
 Bol ronde  
 Früchtekorb rund  
 Cuenco redondo

Ø cm. 28 Ø 11"  
 H cm. 17,3 H 6 5/8"  
 lt. 6,03 qt. 6 1/3

599

58928

7 colori disponibili - pag. 312 - 313  
 7 colors available - pages 312 - 313  
 7 couleurs disponibles - pag. 312 - 313  
 7 verschiedenen Farben verfügbar - Seiten 312 - 313  
 7 colores disponibles - pag. 312 - 313

589 - Ø cm. 28  
 Ø 11"



666C



mm. 1,2 UNO  
 Colonna portasecchiello spumante  
 Wine cooler stand  
 Pied pour seau à champagne  
 Weinkühlerständer  
 Columna porta cubo champany  
 H cm. 67,5 H 26 5/8"

598

59870

Logo traforato a richiesta  
 Fretworked logo on demand  
 Logo ajourée sur demande  
 Firmenzeichen gelocht auf Verlangen  
 Logo perforado en demanda

589 - Ø cm. 64  
 Ø 25 1/4"

589 - Ø cm. 28  
 Ø 11"



598  
 mm. 1,2 Secchiello Ø cm. 29 Ø 11 3/8"  
 Basket H cm. 18,5 H 7 1/4"  
 Corbeille lt. 8 gal. 2  
 Fruchtkorb  
 Cesta

59870  
 mm. 1,2 Big Champagnera Ø cm. 67,5 Ø 26 3/8"  
 Champagne bowl H cm. 43 H 17"  
 Bol a champagne lt. 80 gal. 21  
 Champagner Bowl  
 Cesta para champany

666K



NEW

mm. 1,2 Colonna porta big champagnera H cm. 51 H 20"  
Champagne bowl stand  
Pied pour bol a champagne  
Champagner Bowlständer  
Columna porta cesta champany

A



Ambra  
Amber  
Amber  
Amber  
Ambar



G



Granato  
Garnet  
Grenat  
Granat  
Granate

M



Ametista  
Amethyst  
Amethyste  
Amethyst  
Amatista

W



Trasparente  
Transparent  
Glace  
Transparent  
Vidrio

Z



Zaffiro  
Saphyre  
Saphir  
Saphir  
Zafiro

S



Smeraldo  
Emerald  
Emeraude  
Smaragd  
Esmeralda

O



Onice  
Onyx  
Onyx  
Onyx  
Onice

909



mm. 1,2 Secchiello per ghiaccio forato  
Ice bucket fretworked handles  
Seau à glaçons anses ajourée  
Eisgefäß mit Griffen  
Cubitera hielo asa perforada

cm. 22 x 20 8 3/4" x 7 7/8"  
H cm. 11,5 H 4 5/8"  
lt. 1,2 oz. 40 1/2

912



mm. 1,2 Secchiello per spumante forato  
Sparkling wine cooler fretw. handles  
Seau à champagne anses ajourée  
Wein- und Sektkühler mit Griffen  
Cubo para champany asa perforada

cm. 39 x 36 15 3/8" x 14 1/4"  
H cm. 17,5 H 7"  
lt. 7 gal. 1 4/5

730

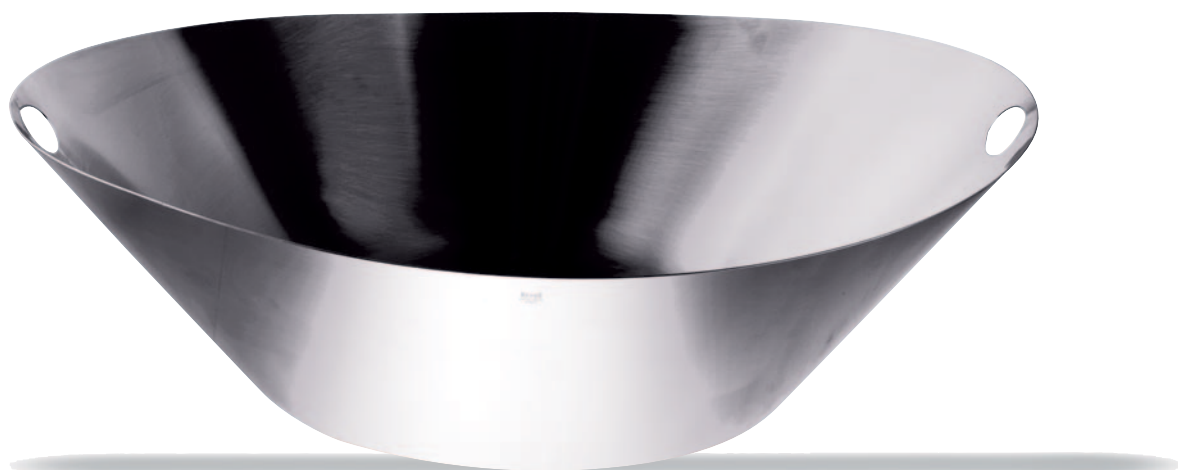

mm. 1,2 Spumantiera 12 bottiglie champagne  
Giant champagne bucket for 12 bottles  
Seau à champagne géante pour 12 bouteilles  
Champagner Bowl für 12 Flaschen  
Cubo de champagne gigante para 12 botellas

cm. 75 x 65 29 1/2" x 25 5/8"  
H cm. 19 H 7 1/2"  
lt. 15 gal. 3 7/8

899



mm. 1,2 Secchiello per ghiaccio  
Ice bucket  
Seau à glaçons  
Eisgefäß  
Cubitera hielo

cm. 22 x 20 8 3/4" x 7 7/8"  
H cm. 11,5 H 4 5/8"  
lt. 1,2 oz. 40 1/2

910



mm. 1,2 Secchiello per spumante  
Sparkling wine cooler  
Seau à champagne  
Wein- und Sektkühler  
Cubo para champany

cm. 39 x 36 15 3/8" x 14 1/4"  
H cm. 17,5 H 7"  
lt. 7 gal. 1 4/5

686



mm. 1,2 Champagnera 5 bott. c/pied. Ø cm. 40 Ø 15 3/4"  
 Giant Champagne bucket 5 bot. H cm. 38,5 H 15 1/6"  
 Seau à champagne p/5 bott. lt. 15 gal. 4  
 Champagner Bowl 5 Fläsche  
 Cubo de champagne p/5 bot.

685



mm. 1,2 Champagnera 5 bott. s/pied. Ø cm. 40 Ø 15 3/4"  
 Giant Champagne bucket 5 bot. H cm. 21,8 H 8 3/5"  
 Seau à champagne p/5 bott. lt. 15 gal. 4  
 Champagner Bowl 5 Fläsche  
 Cubo de champagne p/5 bot.

666I



mm. 1,2 Colonna portabottiglie spumante H cm. 78 H 30 5/7"  
 Wine cooler stand  
 Pied pour seau à champagne  
 Weinkühlerständer  
 Columna porta cubo champany

674



mm. 1,2 Spumantiera termica 5 bott. s/pied. Ø cm. 40 Ø 15 3/4"  
 Giant insulated Champagne bucket 5b. H cm. 21,8 H 8 3/5"  
 Seau à champagne thermique p/5 bou. lt. 15 gal. 4  
 Isolier Champagner Bowl 5 Fläsche  
 Cubo térmico para champagne p/5 bot.

698

NEW



mm. 1,2 Raccogli tappi in sughero cm. 12 x 6 4 3/4" x 2 1/5"  
 Corks holder cl. 15 oz. 5 1/8  
 Porte-bouchons  
 Korkenhalter  
 Porta corchos

380



382  
Lungh. cm. 17,5  
Length 6<sup>7</sup>/<sub>8</sub>"  
mm. 1,5

mm. 1,2 ERGONOMICA  
Secchiello e molla per ghiaccio  
Ice bucket and ice tongs  
Seau à glaçons et pince à glaçons  
Eisgefäß und Eiszange  
Cubitera hielo y pinzas hielo

cl. 200  
oz. 67 <sup>5</sup>/<sub>8</sub>

381



mm. 1,2 ERGONOMICA  
Secchiello per spumante  
Sparkling wine cooler  
Seau à champagne  
Wein-und Sektkühler  
Cubo para champany

lt. 4,5  
gal. 1<sup>1</sup>/<sub>4</sub>

683



mm. 1,2 Secchio per ghiaccio  
Ice bucket with grill  
Seau à glaçons  
Eisgefäß  
Cubitera hielo

Ø cm.14 Ø 5<sup>1</sup>/<sub>2</sub>"  
H.cm.13 H. 5<sup>5</sup>/<sub>8</sub>"  
cl. 150 oz. 50<sup>3</sup>/<sub>4</sub>

684



mm. 1,2 Secchio per spumante  
Sparkling wine cooler  
Seau à champagne  
Wein-und Sektkühler  
Cubo para champany

Ø cm.23 Ø 9"  
H cm.22,5 H 8<sup>7</sup>/<sub>8</sub>"  
lt. 8,5 gal. 2<sup>1</sup>/<sub>4</sub>

941



mm. 1,2 Portacannucce  
Straw holder  
Porta pailles  
Strohalm Halter  
Porta-palillas

Ø cm. 9 Ø 3 <sup>1</sup>/<sub>4</sub>"

10001150



mm. 1,2 Golf club mixer spoon  
Golf club mixer spoon  
Golf crosse pour cocktail  
Golf Schleger für Long drink  
Golf club cucharita coctél

cm. 16,5 6 <sup>1</sup>/<sub>2</sub>"

438



mm. 1,2

OVO  
Secchiello per spumante  
Sparkling wine cooler  
Seau à champagne  
Wein- und Sektkühler  
Cubo para champany

Ø cm. 19    Ø 7 1/2"  
H cm. 22    H 8 5/8"  
lt. 4,5      gal. 1 1/4

439



mm. 1,2

OVETTO  
Secchiello per ghiaccio  
Ice-bucket  
Seau à glaçons  
Eisgefäß  
Cubitera hielo

Ø cm. 11    Ø 4 3/8"  
H cm. 13    H 5 1/8"  
cl. 100      oz. 33 7/8

689



mm. 1,2

Secchiello per spumante  
Sparkling wine cooler  
Seau à champagne  
Wein- und Sektkühler  
Cubo para champany

Ø cm. 19    Ø 7 1/2"  
H cm. 20    H 7 3/4"  
lt. 2,5      oz. 84 1/2

688



mm. 1,2

Secchiello per ghiaccio  
Ice-bucket  
Seau à glaçons  
Eisgefäß  
Cubitera hielo

Ø cm. 11    Ø 4 3/8"  
H cm. 12,5    H 4 7/8"  
cl. 55        oz. 18 5/8

658



Cubetto luminoso confez. 72 pezzi    cm. 2,5 x 2,5    1" x 1"  
LED ice cube 72 pcs. box            H cm. 2,5      H 1"  
Glaçons lumineux 72 pièces  
Eiswürfel LED 72 Stücke  
Cubito hielo LED 72 piezas

Idoneo al contatto con gli alimenti.

Suitable for contact with food

Materiale certificato:  
LFGB - German Food, Commodities and Animal Feed Code of Law  
DIN 10955 - 2004  
ISO 11885:2007  
BfR Recommendations on Food Contact Materials - part V & VI 2010 & 2010  
Regolamento CEE (EU) 10/2011  
Regolamento CEE (EC) 1907/2006  
Regolamento CEE (EC) 1935/2004

Certified material:  
LFGB - German Food, Commodities and Animal Feed Code of Law  
DIN 10955 - 2004  
ISO 11885:2007  
BfR Recommendations on Food Contact Materials - part V & VI 2010 & 2010  
Regulation CEE (EU) 10/2011  
Regulation CEE (EC) 1907/2006  
Regulation CEE (EC) 1935/2004

Durata delle batterie: 12 ore

Battery life: 12 hours

# Front Cooking



## FRONT COOKING

- Design e performance tecniche combinati alla perfezione
  - Adatte a tutte le fonti di calore e cottura
  - Manici ergonomici
  - Progettate in collaborazione con i più importanti produttori di cucine professionali per far rendere al meglio fuochi ed induzione
- 
- Perfect combination of technical performance and design.
  - Suitable for all hobs.
  - Ergonomic handles.
  - Projected in cooperation with the most important manufacturers of professional kitchens, in order to perform hobs and induction at their best.
- 
- Design et performance techniques combinées à la perfection
  - Aptes à toutes les font de chaleur et de cuisson
  - Poignées ergonomiques
  - Conçues en collaboration avec les principaux producteurs de cuisines professionnelles afin de rendre les feux et l'induction plus performants.
- 
- Perfekte Kombination aus technische Leistung und Design.
  - Für alle Kochfelder geeignet.
  - Ergonomische Griffe.
  - Projektiert in Zusammenarbeit mit den wichtigsten Hersteller von Profiküchen, um Kochfelder und Induktion optimal zur Geltung zu bringen.
- 
- Perfecta combinación de prestaciones técnicas y Design.
  - Apto para todas las placas.
  - Asas ergonómicas.
  - Proyectado en cooperación con los más importantes fabricantes de cocinas profesionales, con el fin de realizar las mejores cocinas e inducción.

**MEPRA**  
S.p.A.

# Apartments

## APARTMENTS

- Design differenti per ogni tipo di stile
- Alte performance su tutti i piani di cottura
- Manici ergonomici ad alta resistenza al calore
- Vasto assortimento di misure
  
- Different Design for any kind of style.
- High performance on every hobs.
- Heat resistant ergonomic handles.
- Wide assortment of sizes.
  
- Différents designs pour chaque style
- Hautes performances sur tous les fonts de cuisson
- Poignées ergonomiques à haute résistance à la chaleur
- Large assortiment de tailles.
  
- Unterschiedliches Design für jeden Stil.
- Höchste Leistung auf allen Kochfeldern.
- Hitzebeständig ergonomisch Griffe.
- Breites Sortiment an Größen.
  
- Design diferente para cualquier tipo de estilo.
- Alto rendimiento en todas las placas.
- Mangos ergonómicos, resistentes al calor.
- Amplia variedad de tallas.







Acciaio Inossidabile 18/10, cuore in alluminio, esterno in acciaio per induzione  
 Superficie esterna ed interna lucidate a specchio  
 Maniglie con rivetti in acciaio inossidabile 18/10, a tenuta rinforzata  
 Il calore si distribuisce uniformemente su tutta la superficie della pentola  
 Maggiore controllo della temperatura di cottura  
 Notevole risparmio di energia e tempo  
 Minor alterazione delle vitamine e proteine durante la cottura

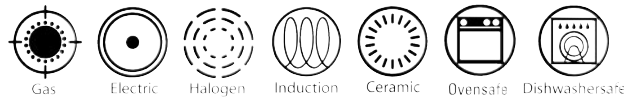

18/10 Stainless Steel, aluminum core, Induction Steel outside  
 Mirror polished surfaces, outside and inside  
 Handles with strongly fixed 18/10 Stainless Steel rivets,  
 The heat is distributed evenly over the surface of the pot  
 Greater control of cooking temperature  
 Considerable saving of energy and time  
 Minor alteration of vitamins and proteins during cooking



### Strato interno - Inner layer

Acciaio Inossidabile 18/10 - Il materiale in assoluto più igienico e più facile da pulire  
 Stainless Steel 18/10 - The material even more hygienic easier to clean

### Strato centrale - Middle layer

Cuore in alluminio - Il materiale leggero, non soggetto a corrosione ed atossico  
 Aluminum core - The lightweight, non-corrosive and non-toxic

### Strato esterno - Outer layer

Acciaio speciale per induzione  
 Special steel for induction



### 1831

Risottiera e tegame per arrosti e brasati in **Trimetallo** con interno in acciaio inossidabile 18/10 senza rivestimento  
**Tri-ply** Low casserole for risotto and stews.

Ø cm. 24 - Lt. 3,0  
 Ø cm. 28 - Lt. 4,0

Ø 9 1/2" - Qt. 3 1/6  
 Ø 11" - Qt. 4 1/5



### 1821

Sauteuse per condimenti e salse in **Trimetallo** con interno in acciaio inossidabile 18/10 senza rivestimento  
**Tri-ply** Casserole for serving sauces, soups and side dishes.

Ø cm. 18 - Lt. 2,0  
 Ø cm. 20 - Lt. 3,0  
 Ø cm. 22 - Lt. 3,5  
 Ø cm. 24 - Lt. 5,0

Ø 7" - Qt. 2 1/9  
 Ø 7 1/8" - Qt. 3 1/6  
 Ø 8 2/3" - Qt. 3 2/3  
 Ø 9 1/2" - Qt. 5 1/3



### 1801

Pentola in **Trimetallo** con interno in acciaio inossidabile 18/10 senza rivestimento  
**Tri-ply** Deep pot

Ø cm. 20 - Lt. 3,5  
 Ø cm. 22 - Lt. 5,0  
 Ø cm. 24 - Lt. 6,5

Ø 7 7/8" - Qt. 3 2/3  
 Ø 8 2/3" - Qt. 5 1/3  
 Ø 9 1/2" - Qt. 6 1/8



### 1811

Mini casserole per soufflé, condimenti e salse in **Trimetallo** con interno in acciaio inossidabile 18/10 senza rivestimento  
**Tri-ply** Mini casseroles for soufflé, condiments and sauces

Ø cm. 9 - Lt. 0,25  
 Ø 3 1/2" - Qt. 1/11  
 Ø cm. 14 - Lt. 1,0  
 Ø 5 1/2" - Qt. 1  
 Ø cm. 16 - Lt. 2,0  
 Ø 6 1/3" - Qt. 2 1/9



### 1821

Mini casserole per soufflé, condimenti e salse in **Trimetallo** con interno in acciaio inossidabile 18/10 senza rivestimento  
**Tri-ply** Mini casseroles for soufflé, condiments and sauces

Ø cm. 12 - Lt. 0,6  
 Ø 4 2/3" - Qt. 1/11



**1841**  
Padella in **Trimetallo**  
**Tri-ply** Frying pan  
Poêle à frire  
Bratpfanne  
Sartén

Ø cm. 22	Ø 8 <sup>2</sup> / <sub>3</sub> "
Ø cm. 26	Ø 10 <sup>1</sup> / <sub>4</sub> "
Ø cm. 30	Ø 11 <sup>3</sup> / <sub>4</sub> "

Acciaio Inossidabile 18/10, cuore in alluminio, esterno in acciaio per induzione  
 Superficie esterna ed interna lucidate a specchio  
 Maniglie con rivetti in acciaio inossidabile 18/10, a tenuta rinforzata  
 Il calore si distribuisce uniformemente su tutta la superficie della pentola  
 Maggiore controllo della temperatura di cottura  
 Notevole risparmio di energia e tempo  
 Minor alterazione delle vitamine e proteine durante la cottura

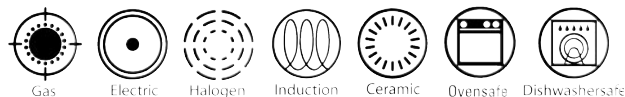

18/10 Stainless Steel, aluminum core, Induction Steel outside  
 Mirror polished surfaces, outside and inside  
 Handles with strongly fixed 18/10 Stainless Steel rivets,  
 The heat is distributed evenly over the surface of the pot  
 Greater control of cooking temperature  
 Considerable saving of energy and time  
 Minor alteration of vitamins and proteins during cooking

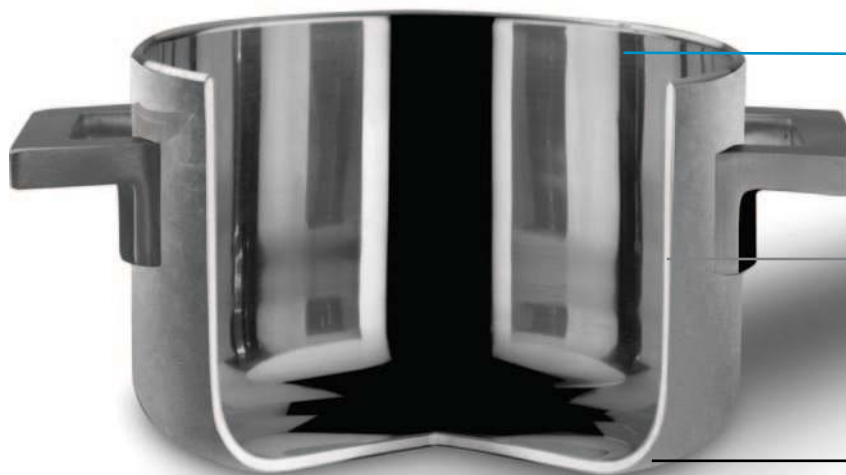

Strato interno - Inner layer

Acciaio Inossidabile 18/10 - Il materiale in assoluto più igienico e più facile da pulire  
 Stainless Steel 18/10 - The material even more hygienic easier to clean

Strato centrale - Middle layer

Cuore in alluminio - Il materiale leggero, non soggetto a corrosione ed atossico  
 Aluminum core - The lightweight, non-corrosive and non-toxic

Strato esterno - Outer layer

Acciaio speciale per induzione  
 Special steel for induction



**2831**

Risottiera e tegame per arrosti e brasati in **Trimetallo** con interno in acciaio inossidabile 18/10 senza rivestimento  
**Tri-ply** Low casserole for risotto and stews.

Ø cm. 24 - Lt. 3,0  
 Ø cm. 28 - Lt. 4,0

Ø 9 1/2" - Qt. 3 1/6  
 Ø 11" - Qt. 4 1/5



**2821**

Sauteuse per condimenti e salse in **Trimetallo** con interno in acciaio inossidabile 18/10 senza rivestimento  
**Tri-ply** Casserole for serving sauces, soups and side dishes.

Ø cm. 18 - Lt. 2,0  
 Ø cm. 20 - Lt. 3,0  
 Ø cm. 22 - Lt. 3,5  
 Ø cm. 24 - Lt. 5,0

Ø 7" - Qt. 2 1/9  
 Ø 7 1/8" - Qt. 3 1/6  
 Ø 8 2/3" - Qt. 3 2/3  
 Ø 9 1/2" - Qt. 5 1/3



**2801**

Pentola in **Trimetallo** con interno in acciaio inossidabile 18/10 senza rivestimento  
**Tri-ply** Deep pot

Ø cm. 20 - Lt. 3,5  
 Ø cm. 22 - Lt. 5,0  
 Ø cm. 24 - Lt. 6,5

Ø 7 7/8" - Qt. 3 2/3  
 Ø 8 2/3" - Qt. 5 1/3  
 Ø 9 1/2" - Qt. 6 1/8



**2811**

Mini casseruole per soufflé, condimenti e salse in **Trimetallo** con interno in acciaio inossidabile 18/10 senza rivestimento  
**Tri-ply** Mini casseroles for soufflé, condiments and sauces

Ø cm. 9 - Lt. 0,25  
 Ø 3 1/2" - Qt. 1/11  
 Ø cm. 14 - Lt. 1,0  
 Ø 5 1/2" - Qt. 1  
 Ø cm. 16 - Lt. 2,0  
 Ø 6 1/3" - Qt. 2 1/9



**2821**

Mini casseruole per soufflé, condimenti e salse in **Trimetallo** con interno in acciaio inossidabile 18/10 senza rivestimento  
**Tri-ply** Mini casseroles for soufflé, condiments and sauces

Ø cm. 12 - Lt. 0,6  
 Ø 4 2/3" - Qt. 1/11



**2841**  
Padella in **Trimetallo**  
**Tri-ply** Frying pan  
Poêle à frire  
Bratpfanne  
Sartén

Ø cm. 22	Ø 8 <sup>2</sup> / <sub>3</sub> "
Ø cm. 26	Ø 10 <sup>1</sup> / <sub>4</sub> "
Ø cm. 30	Ø 11 <sup>3</sup> / <sub>4</sub> "

Acciaio Inossidabile 18/10, cuore in alluminio, esterno in acciaio per induzione  
 Superficie esterna ed interna lucidate a specchio  
 Maniglie con rivetti in acciaio inossidabile 18/10, a tenuta rinforzata  
 Il calore si distribuisce uniformemente su tutta la superficie della pentola  
 Maggiore controllo della temperatura di cottura  
 Notevole risparmio di energia e tempo  
 Minor alterazione delle vitamine e proteine durante la cottura

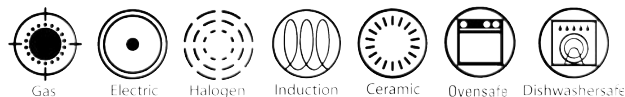

18/10 Stainless Steel, aluminum core, Induction Steel outside  
 Mirror polished surfaces, outside and inside  
 Handles with strongly fixed 18/10 Stainless Steel rivets,  
 The heat is distributed evenly over the surface of the pot  
 Greater control of cooking temperature  
 Considerable saving of energy and time  
 Minor alteration of vitamins and proteins during cooking



### Strato interno - Inner layer

Acciaio Inossidabile 18/10 - Il materiale in assoluto più igienico e più facile da pulire  
 Stainless Steel 18/10 - The material even more hygienic easier to clean

### Strato centrale - Middle layer

Cuore in alluminio - Il materiale leggero, non soggetto a corrosione ed atossico  
 Aluminum core - The lightweight, non-corrosive and non-toxic

### Strato esterno - Outer layer

Acciaio speciale per induzione  
 Special steel for induction



### 18310

Risottiera e tegame per arrosti e brasati in **Trimetallo** con interno in acciaio inossidabile 18/10 senza rivestimento  
**Tri-ply** Low casserole for risotto and stews.

Ø cm. 24 - Lt. 3,0  
 Ø cm. 28 - Lt. 4,0

Ø 9 1/2" - Qt. 3 1/6  
 Ø 11" - Qt. 4 1/5



### 18210

Sauteuse per condimenti e salse in **Trimetallo** con interno in acciaio inossidabile 18/10 senza rivestimento  
**Tri-ply** Casserole for serving sauces, soups and side dishes.

Ø cm. 18 - Lt. 2,0  
 Ø cm. 20 - Lt. 3,0  
 Ø cm. 22 - Lt. 3,5  
 Ø cm. 24 - Lt. 5,0

Ø 7" - Qt. 2 1/9  
 Ø 7 1/8" - Qt. 3 1/6  
 Ø 8 2/3" - Qt. 3 2/3  
 Ø 9 1/2" - Qt. 5 1/3



### 18010

Pentola in **Trimetallo** con interno in acciaio inossidabile 18/10 senza rivestimento  
**Tri-ply** Deep pot

Ø cm. 20 - Lt. 3,5  
 Ø cm. 22 - Lt. 5,0  
 Ø cm. 24 - Lt. 6,5

Ø 7 7/8" - Qt. 3 2/3  
 Ø 8 2/3" - Qt. 5 1/3  
 Ø 9 1/2" - Qt. 6 1/8



### 18110

Mini casseruole per soufflé, condimenti e salse in **Trimetallo** con interno in acciaio inossidabile 18/10 senza rivestimento  
**Tri-ply** Mini casseroles for soufflé, condiments and sauces

Ø cm. 9 - Lt. 0,25  
 Ø 3 1/2" - Qt. 1/11  
 Ø cm. 14 - Lt. 1,0  
 Ø 5 1/2" - Qt. 1  
 Ø cm. 16 - Lt. 2,0  
 Ø 6 1/3" - Qt. 2 1/9



### 18210

Ø cm. 12 - Lt. 0,6  
 Ø 4 2/3" - Qt. 1/11



**18410**  
Padella in **Trimetallo**  
**Tri-ply** Frying pan  
Poêle à frire  
Bratpfanne  
Sartén

Ø cm. 22	Ø 8 <sup>2</sup> / <sub>3</sub> "
Ø cm. 26	Ø 10 <sup>1</sup> / <sub>4</sub> "
Ø cm. 30	Ø 11 <sup>3</sup> / <sub>4</sub> "





Rame, cuore in alluminio, interno in acciaio inossidabile 18/10 - Superficie esterna ed interna lucidate a specchio - Maniglie con rivetti in acciaio inossidabile 18/10, a tenuta rinforzata

Il calore si distribuisce uniformemente su tutta la superficie della pentola - Maggiore controllo della temperatura di cottura - Notevole risparmio di energia e tempo - Minor alterazione delle vitamine e proteine durante la cottura

Copper, aluminum core, 18/10 Stainless Steel inside - Mirror polished surfaces, outside and inside - Handles with strongly fixed 18/10 Stainless Steel rivets.

The heat is distributed evenly over the surface of the pot - Greater control of cooking temperature - Considerable saving of energy and time - Minor alteration of vitamins and proteins during cooking.

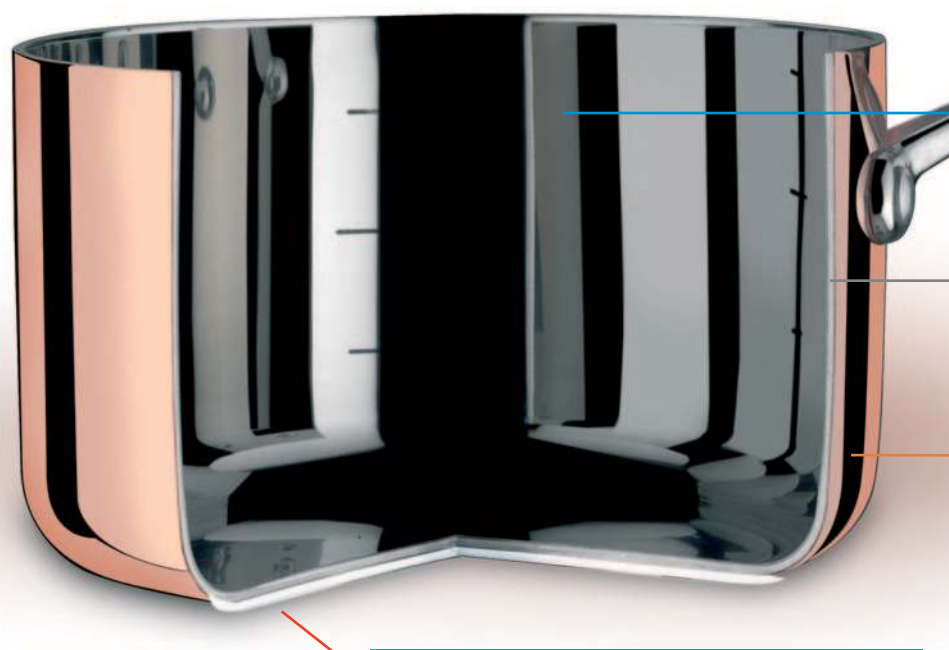
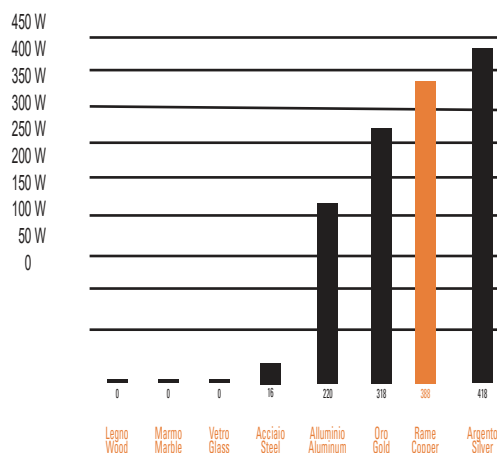

Strato interno - Inner layer

Acciaio Inossidabile 18/10 - Il materiale in assoluto più igienico e più facile da pulire  
Stainless Steel 18/10 - The material even more hygienic easier to clean

Strato centrale - Middle layer

Cuore in alluminio - Il materiale leggero, non soggetto a corrosione ed atossico  
Aluminum core - The lightweight, non-corrosive and non-toxic

Strato esterno - Outer layer

Rame - Il materiale a più alta conduttività dopo l'argento  
Copper - The material with higher conductivity after silver

Fondo speciale - Special bottom

Adatto all'induzione - Suitable for inductions stoves too.

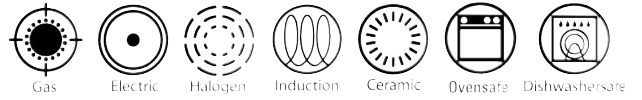

**1231**

Risottiera e tegame per arrosti e brasati in **Trimetallo** con interno in acciaio inossidabile 18/10 senza rivestimento.  
 Low casserole for risotto and stews. **Tri-ply** with 18/10 inside, aluminum and copper.  
 Ø cm. 28 - Lt. 4,5      Ø 11" - Qt. 4 1/2



**1211**

Sauteuse per condimenti e salse in **Trimetallo** con interno in acciaio inossidabile 18/10 senza rivestimento.  
**Tri-ply** saucepan with 18/10 inside, aluminum and copper.  
 Ø cm. 16 - Lt. 1,9      Ø 6 1/3" - Qt. 1



**1241**

Padella in **Trimetallo** con interno in acciaio inossidabile 18/10 senza rivestimento  
**Tri-ply** frying pan with 18/10 inside, aluminum and copper.  
 Ø cm. 26 - Lt. 2,9      Ø 10 1/4" - Qt. 2 1/8



**1201**

Pentola in **Trimetallo** con interno in acciaio inossidabile 18/10 senza rivestimento  
**Tri-ply** deep pot with 18/10 inside, aluminum and copper.  
 Ø cm. 20 - Lt. 4,0      Ø 7 7/8" - Qt. 4 1/5  
 Ø cm. 24 - Lt. 7,7      Ø 9 1/2" - Qt. 8 1/8



**1221**

Casseruola per soufflé, condimenti e salse in **Trimetallo** con interno in acciaio inossidabile 18/10 senza rivestimento  
**Tri-ply** Saucepan for soufflé, seasonings and sauces with 18/10 inside, aluminum and copper.  
 Ø cm. 20 - Lt. 2,9      Ø 7 7/8" - Qt. 3  
 Ø cm. 24 - Lt. 3,5      Ø 9 1/2" - Qt. 3 2/3



**2179**  
Padella antiaderente  
Non-stick frying pan  
Poêle à frire anti-adhérent  
Antihaft Bratpfanne  
Sartén antiadherente

Ø cm. 20	Ø 7 <sup>1</sup> / <sub>8</sub> "
Ø cm. 24	Ø 9 <sup>1</sup> / <sub>2</sub> "
Ø cm. 28	Ø 11"
Ø cm. 32	Ø 12 <sup>4</sup> / <sub>5</sub> "



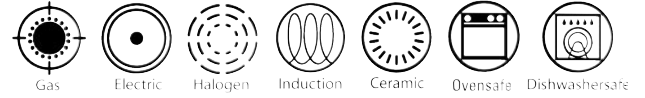

Strato interno - Inner layer

Rivestimento triplo strato antiaderente di ultima generazione, antimacchia. Rivestimento resistente agli utensili metallici non taglienti.

The last generation triple non-stick layer is so strong, that allow you to cook with non-sharp metal utensils.

Strato esterno - Outer layer

Triplo fondo incapsulato per cottura ad induzione

Sandwiched thermoradiant bottom for induction cooking

Acciaio Inossidabile 18/10 - Fondo termodiffusore incapsulato (Acciaio Inossidabile 18/10 - Alluminio - Acciaio per induzione). Bordo antigoccia rinforzato - Lavabile in lavastoviglie senza che ne venga compromessa l'antiaderenza. Le eccezionali proprietà antiaderenti permettono una cucina completamente priva di grassi, per uno stile di vita attivo e salutare. Rispetto della natura e del pianeta, grazie alla totale assenza di PFOA.

18/10 Stainless Steel - Sandwiched thermoradiant bottom (18/10 Stainless Steel - Aluminum - Steel for Induction). Reinforced non-drip edge. The non-stick coating is not compromised during the washing cycle. The outstanding non-stick properties also allow a fully fatfree cuisine, for an active and healthy life. Thanks to the total absence of PFOA, the collection respects the nature.



**2180**

Bistecchiera ad alto spessore per alte temperature con rivestimento antiaderente, PFOA Free, per induzione, antimacchia, antigraffio.

High gauge steak pan for high heat with "Eterna" non-stick coating, PFOA free, stain resistant and scratch resistant.

cm. 28 x 28 11" x 11"



**2131**

Risottiera e tegame per arrostiti e brasati con coperchio per alte temperature con rivestimento antiaderente, PFOA Free, per induzione, antimacchia, antigraffio.

Low casserole for risotto and stews with "Eterna" non-stick coating, PFOA free, stain resistant and scratch resistant.

Ø cm. 32 - Lt. 5,0 Ø 12 3/5" - Qt. 5 1/7



**2178**

Wok saltapasta con coperchio per alte temperature con rivestimento antiaderente, PFOA Free, per induzione, antimacchia, antigraffio.

Wok with lid for high heat with "Eterna" non-stick coating, PFOA Free, for induction, stain resistant and scratch resistant.

Ø cm. 28 - Lt. 3,0 Ø 11 1/4" - Qt. 3 1/2

# GOURMET



Gas



Electric



Halogen



Induction



Ceramic



Ovensafe



Dishwashersafe



**1501**  
Pentola alta con coperchio  
Deep pot with lid

Ø cm. 20 - Lt. 4,2      Ø 7 7/8" - Qt. 4 2/7  
Ø cm. 22 - Lt. 4,8      Ø 8 2/3" - Qt. 5  
Ø cm. 24 - Lt. 5,4      Ø 9 1/2" - Qt. 5 2/3



**1511**  
Casseruola 1 manico con coperchio  
Deep casserole 1 handle with lid

Ø cm. 16 - Lt. 1,5      Ø 6 1/3" - Qt. 1 2/5



**1521**  
Casseruola fonda 2 manici con coperchio  
Deep casserole 2 handles with lid

Ø cm. 20 - Lt. 2,9      Ø 7 7/8" - Qt. 3  
Ø cm. 22 - Lt. 3,3      Ø 8 2/3" - Qt. 3 1/2  
Ø cm. 24 - Lt. 3,8      Ø 9 1/2" - Qt. 4



**1531**  
Tegame 2 manici con coperchio  
Frying pan 2 handles with lid

Ø cm. 26 - Lt. 3,3      Ø 10 1/4" - Qt. 3 1/2  
Ø cm. 30 - Lt. 5,6      Ø 11 4/5" - Qt. 5 7/8



**1500/08**

Batteria da cucina 8 pezzi  
8 pcs. Kitchen set  
Composta da - Composed by:

1 Pentola alta - Deep pot	Ø cm. 20	Ø 7 7/8"
1 Casseruola 1 manico	Ø cm. 16	Ø 6 1/3"
1 Deep casserole 1 handle		
1 Casseruola 2 manici	Ø cm. 20	Ø 7 7/8"
1 Deep casserole 2 handles		
1 Tegame 2 manici	Ø cm. 26	Ø 10 1/4"
1 Frying pan 2 handles		
2 Coperchi - Lids	Ø cm. 20	Ø 7 7/8"
1 Coperchio - Lid	Ø cm. 16	Ø 6 1/3"
1 Coperchio - Lid	Ø cm. 26	Ø 10 1/4"



**1500/14**

Batteria da cucina 14 pezzi  
14 pcs. Kitchen set  
Composta da - Composed by:

1 Pentola alta - Deep pot	Ø cm. 20	Ø 7 7/8"
1 Casseruola 1 manico	Ø cm. 16	Ø 6 1/3"
1 Deep casserole 1 handle		
1 Casseruola 2 manici	Ø cm. 20	Ø 7 7/8"
1 Deep casserole 2 handles		
1 Tegame 2 manici	Ø cm. 26	Ø 10 1/4"
1 Frying pan 2 handles		
1 Spghettiera	Ø cm. 22	Ø 8 2/3"
1 Pasta pot (3pcs)		
1 Cuociverdura	Ø cm. 22	Ø 8 2/3"
1 Vegetable steamer (3pcs)		
1 Coperchio - Lid	Ø cm. 16	Ø 6 1/3"
2 Coperchi - Lids	Ø cm. 20	Ø 7 7/8"
1 Coperchio - Lid	Ø cm. 26	Ø 10 1/4"





**1579**  
Padella antiaderente  
Non-stick frying pan  
Poêle à frirre anti-adhérent  
Antihaft Bratpfanne  
Sartén antiadherente  
Ø cm. 22      Ø 8 <sup>1</sup>/<sub>3</sub>"  
Ø cm. 26      Ø 10 <sup>1</sup>/<sub>4</sub>"  
Ø cm. 30      Ø 11 <sup>1</sup>/<sub>5</sub>"



# GOURMET

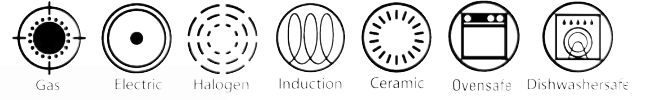

**1578**  
Wok antiaderente con coperchio  
Non-stick wok with lid

Ø cm. 30 - Lt. 5,0      Ø 11 3/4" - Qt. 5 1/4



**1581**  
Bollilatte  
Milk boiler

cm. 12 - Lt. 1,2

Ø 4 3/4" - Qt. 1 1/2



**1591**  
Inserto cuocipasta 2 scomparti  
Pasta pot insert 2 compt.

Per pentola Ø cm. 24  
For pot Ø 9 1/2"



**883**  
Colapasta  
Colander

cm. 33      13"



**1571**  
Cuocipasta con coperchio  
Pasta pot with lid

Ø cm. 22 - Lt. 6,6

Ø 8 2/3" - Qt. 7



**1572**  
Cuociverdura con coperchio  
Vegetable steamer with lid

Ø cm. 22 - Lt. 4,3

Ø 8 2/3" - Qt. 4 1/2

# Spa & Wellness



- Infrangibile
- Adatto alla lavastoviglie
- Adatto al forno a microonde
- Ideale per:
- Discoteche
- Yacht e navi da crociera
- Cliniche
- Case di riposo per anziani
- Asili
- Ideale per tutti i luoghi dove i clienti possono accedere a piedi nudi:
- Piscine
- Spiagge
- Prati
- Centri di benessere
- Impianti sportivi
- Tonalità diverse disponibili a richiesta
- Possono essere personalizzati con logo, anche a più colori

- Unbreakable
- Dishwasher Safe
- Microwave Safe
- Ideal for:
- Night Clubs
- Yachts and Cruise Ships
- Hospitals and Medical Clinics
- Rest Homes
- Schools
- Perfect for Barefoot Environments:
- Swimming Pools
- Beaches
- Lawns
- Wellness Centers
- Fitness Centers
- Available in additional colors.
- Imprinting and logos available. Multicolor printing available.

- Incassable
- Utilisable au laves-vaisselles
- Utilisable au Four à micro-ondes
- Idéal pour :
- Discothèques
- Yacht et bateaux de croisière
- Cliniques
- Maisons de repos
- Crèches
- Idéal pour tous les lieux où les clients peuvent accéder à pied nus :
- Piscines
- Plages
- Jardin
- Centre de bien-être

- Installations sportives
- Tonalités différentes disponibles sur demande  
Ils peuvent être personnalisés avec logo, multicouleurs, gravées ou lazer

- Unzerbrechlich
- Spülmaschinenfest
- Microwellenfest
- Daher bestens geeignet zum Gebrauch:
- in Cocktailbars & Night Clubs
- für Yachten und Kreuzfahrtschiffe
- in Kliniken und Heimen
- in Badezimmern
- für Schulen und Kindergärten

Auch aufgrund der Bruchsicherheit perfekt einzusetzen an Orten, die barfuß betreten werden:

- Schwimmbäder und Poolbereiche
- Strände und Strandbars
- Rasenflächen
- Wellnesscenter
- Fitnesscenter
- Alle Produkte sind auch in zusätzlichen, weiteren Farben erhältlich.
- Alle Produkte können auch mit Logos und Beschriftung individualisiert werden.
- Dabei ist auch mehrfarbiger Druck möglich.

- Irrrompible
- Apto para lavavajillas
- Apto para microondas
- Ideal para:
- Discotecas
- Yates y barcos de crucero
- Clinicas
- Residencias de ancianos
- Asilos
- Ideal para todos los lugares donde los clientes pueden ir descalzos:
- Piscinas
- Playas
- Praderas
- Centros de bienestar
- Centros deportivos
- Tonos diversos disponibles por encargo
- Se pueden personalizar con logo, incluso en varios colores.



588



Bicchiere  
Glass  
Gobelet  
Glas  
Vaso

H cm 10  
cl. 33  
H 3 7/8"  
oz. 11 1/8

591



Bicchiere  
Glass  
Gobelet  
Glas  
Vaso

H cm 13  
cl. 45  
H 5"  
oz 15 1/4

554



Fondo  
Bowl  
Bol  
Obstschale oval  
Cuenco

Ø cm. 18    Ø 7"

553

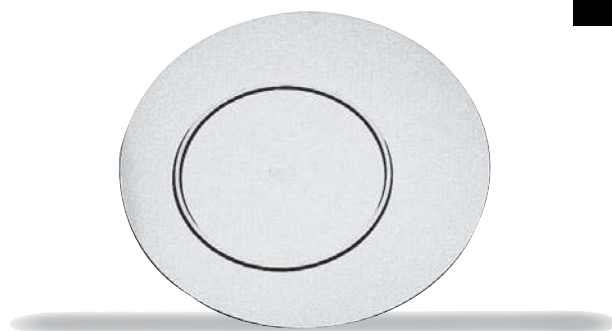

Piano  
Tray  
Plateau  
Tablett oval  
Bandeja

Ø cm. 27    Ø 10 1/2"

555



Piano per buffet  
Tray for buffet  
Plateau pour buffet  
Buffettablett  
Bandeja para buffet

Ø cm. 27    Ø 10 1/2"

536



Coppa per gelato  
Ice cream cup  
Coupe à glace  
Eisbecher  
Copa helado

H cm 12 H 4 3/4"  
cl. 27 oz 9 1/8

535



Coppa Martini  
Martini glass  
Coupe à Martini  
Martini glas  
Vaso para Martini

H cm. 19 H 7 1/2"  
cl 27 oz 9 1/8

534



Bicchiere per birra  
Beer glass  
Gobelet pour birre  
Bierbecher  
Vaso para cerveza

H cm. 17,5 H 6 7/8"  
cl 45 oz 15 1/8

533



Bicchiere per vino  
Beverage glass  
Gobelet pour vin  
Weinbecher  
Vaso para vino

H cm. 24,5 H 9 1/3"  
cl 45 oz 15 1/8

527



Bicchiere da whisky cl. 15  
Whisky glass oz. 5 1/8  
Gobelet pour whisky  
Whisky Becher  
Vaso para whisky

531

Bicchiere da liqueure cl. 9  
Liquor glass oz. 3  
Gobelet pour alcool  
Schnapsbecher  
Vaso para alcohol

543



Bicchiere per champagne  
Champagne glass  
Gobelet pour champagne  
Champagnerglas  
Vaso para champany

H cm. 22,7 H 9"  
cl. 15 oz. 5 1/8

589



Ciotola tonda  
Round bowl  
Bol ronde  
Früchtekorb, rund  
Cuenco redondo

Ø cm. 12    Ø 4 3/4"  
H cm. 7,4    H 2 7/8"  
cl. 40        oz. 13 1/2

605



Set impilabile di 3 coppette tonde  
Stackable set of 3 round bowls  
Set empilable de 3 bols ronde  
Stapelbarer Relish-Pickles-Gestell, rund  
Set impilable de 3 cuencos redondos

cl. 40 (x 3)    oz. 13 1/2 (x 3)

589



Ciotola tonda  
Round bowl  
Bol ronde  
Früchtekorb rund  
Cuenco redondo

Ø cm. 22    Ø 8 1/2"  
H cm. 14    H 5 1/2"  
cl. 220      oz. 74 3/8

589+599



589



Ciotola tonda  
Round bowl  
Bol ronde  
Früchtekorb rund  
Cuenco redondo

Ø cm. 28    Ø 11"  
H cm. 17,3    H 6 5/8"  
lt. 6,03      oz. 202 1/2

550



Mug

H cm 10  
cl. 33  
H 3 7/8"  
oz. 11 1/8

552



Piattino per mug e bicchieri (Art. 550,588,591) Ø cm. 13,2 Ø 5 1/4"  
Mug coaster (Art. 550,588,591)  
Dessous de verre (Art. 550,588,591)  
Gläseruntersatz (Art. 550,588,591)  
Posavasos por mug (Art. 550,588,591)

592



Tazzina da caffè con piattino  
Express coffee cup and saucer  
Tasse de moka avec soucoupe  
Mokka Tasse mit Untertasse  
Taza de moka con platillo

cl 9 oz. 3

593



Tazza da tè con piattino  
Tea cup and saucer  
Tasse de thé avec soucoupe  
Tee Tasse mit Untertasse  
Taza de tè con platillo

cl 15 oz 5 1/8

590



Ciotola quadra  
Square bowl  
Bol carrè  
Obstschale viereckig  
Cuenco cuadrado

cm. 10 x 10 3 7/8" x 3 7/8"  
cl. 27 oz. 9 1/8

606



Set impilabile di 3 coppette quadre  
Stackable set of 3 square bowls  
Set empilable de 3 bols carrè  
Stapelbarer Relish-Pickles-Gestell,  
quadratisch  
Set impilable de 3 cuencos cuadrados

cl. 27 (x 3) oz. 9 1/8 (x 3)



**A** Ambra  
Amber  
Ambre  
Amber  
Ambar



**G** Granato  
Garnet  
Grenat  
Granat  
Granate



**Q** Quarzo  
Quartz  
Quartz  
Quarz  
Cuarzo



**S** Smeraldo  
Emerald  
Émeraude  
Smaragd  
Esmeralda



**V** Olivina  
Olivine  
Olivine  
Olivia  
Olivino



**Z** Zaffiro  
Sapphyre  
Saphir  
Saphir  
Zafiro

Tutti gli articoli da pagina 342 a pagina 345 sono disponibili in 8 colori, tranne il nero. Gli articoli 533, 534, 535, 536 e 543 sono disponibili solo in 3 colori: bianco, nero e trasparente.

All the items from page 342 to page 345 are available in 8 colors, black excluded. The items 533, 534, 535, 536 and 543 are available in 3 colors only: white, black and transparent.

Tous les articles de la page 342 à la page 345 sont disponibles en 8 couleurs, noir exclu. Les articles 533, 534, 535, 536 et 543 sont uniquement disponibles en 3 couleurs: porcelain, noir et transparent.



**M** Ametista  
Amethyst  
Amethyst  
Amethyst  
Amatista

Alle Polikarbonat-Produkte von Seite 342 bis Seite 345 sind in 8 Farben erhältlich, außer Schwarz. Die Artikel 533, 534, 535, 536 und 543 sind nur in 3 Farben erhältlich: Weiß, Schwarz und Transparent.

Todos los artículos desde la página 342 hasta la página 345 están disponibles en 8 colores, excepto el negro. Los artículos 533, 534, 535, 536 y 543 solo están disponibles en 3 colores: porcelana, negro y transparente.



**W** Trasparente  
Transparent  
Glace  
Transparent  
Vidrio



**B** Berillo  
Beryl  
Beryl  
Beryl  
Berilo



**O** Onice  
Onyx  
Onyx  
Onyx  
Onice



**P** Porcellana  
White  
Porcelain  
Weiss  
Porcelana



**N** Nero  
Black  
Noir  
Schwarz  
Negro



**R** Rosso  
Red  
Rouge  
Rot  
Rojo



886



Secchiello per ghiaccio  
Ice bucket  
Seau à glaçons  
Eisgefäß  
Cubitera hielo

Ø cm. 15    Ø 5 7/8"  
H cm. 15    H 5 7/8"  
cl. 150      oz. 50 3/4

888



Secchiello per spumante  
Sparkling wine cooler  
Seau à vin/glace  
Wein- und Sektkühler  
Cubo para champany

Ø cm. 22    Ø 8 7/8"  
H cm. 22    H 8 7/8"  
lt. 5        gal. 1 1/4

891



Bicchiere  
Glass  
Gobelet  
Glas  
Vaso

H cm. 13    H 5"  
cl. 33        11 1/8 oz

892



Bicchiere  
Glass  
Gobelet  
Glas  
Vaso

H cm. 10    H 4"  
cl. 25        8 7/8 oz

517

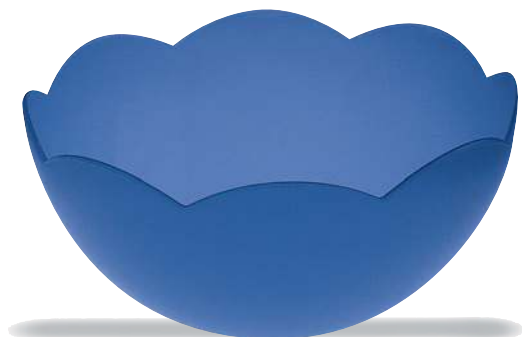

Ciotola  
Bowl  
Bol  
Obstschale  
Cuenco

Ø cm. 10    Ø 3 7/8"  
cl. 30        oz. 10 1/8  
Ø cm. 15    Ø 5 7/8"  
cl. 60        oz. 20 1/4  
Ø cm. 22    Ø 8 7/8"  
cl. 200      oz. 67 7/8  
Ø cm. 28    Ø 11"  
lt 4         gal. 1

099



Sottopiatto  
Charger  
Assiette de bienvenue  
Platzteller  
Bajo plato

CARAMELLA    Ø cm. 32    Ø 12 7/8"  
"                    "  
"                    "  
"                    "

892



**W** Ghiaccio  
Ice  
Glace  
Eis  
Hielo



**O** Arancio  
Orange  
Orange  
Orange  
Naranja



**G** Limone  
Lemon  
Jaune  
Zitrone  
Amarillo



**E** Verde acido  
Acid green  
Vert acide  
Azid Grün  
Pistacho



**B** Anice  
Anis  
Bleu  
Blau  
Azul



**U** Luce di Wood  
Wood light  
Lumière de Wood  
Schwarzlicht  
Luz de Wood

Solo art. 891 - 892  
Only for art. 891 - 892  
Seulement pour art. 891 - 892  
Nur für Art. 891 - 892  
Solo para art. 891 - 892

Tutti gli articoli di pagina 348 sono disponibili in 5 colori

All the items of page 348 are available in 5 colors

Toutes les articles de page 348 sont disponibles en 5 couleurs

Alle Produkte von Seite 348 sind in 5 Farben bzw. Ausführungen erhältlich

Todos los artículos de pagina 348 son disponibles en 5 colores

# Trolleys



- Carrelli multifunzionali  
Vasta gamma di accessori disponibili
- Molteplici finiture
- Ruote speciali a grandezza maggiorata, fascia in gomma antistatica e antitraccia
- Angolari rinforzati
- Logo a richiesta

- Multifunctional trolleys  
A complete range of optional accessories
- Numerous customization choices
- The oversized wheels are anti-static, won't leave marks.
- Reinforced legs
- Company logo on demand

- Chariots multifonctions  
Complète dotation d'accessoires disponibles
- Variété de finitions
- Roulettes surdimensionnées spéciales, avec bande en caoutchouc synthétique conducteur antitraçage
- Arêtes renforcées
- Logo à la demande

- Multifunktioneller Trolley  
Grosse Auswahl von optionalem Zubehör
- Grosse Auswahl von Oberflächen- Variationen und Lack-Farben
- Besonders grossdimensionierte Rollen mit antistatischen Gummireifen, die keinen Abrieb hinterlassen
- Spezialverstärkte Beine
- Ihr Firmen-Logo auf Wunsch als Option

- Carros multifunción  
Vasta gama de accesorios opcionales
- Múltiples acabados
- Ruedas especiales de mayor tamaño, con cinta de goma antistática y antihuellas
- Angulares reforzados
- Logo a solicitud

**MEPRÁ**  
S.p.A.

# TROLLEYS

## LONDON



Gueridon

H cm 80  
cm 80 x 40

H 31 1/2"  
31 1/2" x 15 3/4"

## DELUXE

031



032



Massello con angolari in acciaio inossidabile 18/10  
Solid wood with 18/10 Stainless Steel legs  
Massif avec arêtes en inox 18/10  
Massivholz, Beine mit Edelstahl Rostfrei 18/10 Pro-  
filen verblendet  
Tablero con angulares en acero inox 18/10

## VIP

036



037



Massello con angolari in massello  
Trolley and solid wood legs  
Panneaux massif  
Trolley und Beine komplett aus Massivholz  
Tablero macizo con angulares macizos

## COLORI

		031 036	032 037	
		Noce Walnut Noyer Walnuss Nuez	Wengè	

# TROLLEYS

## HAVANA



H cm 87  
cm 50 x 50

H 34 <sup>1</sup>/<sub>4</sub>"  
19 <sup>3</sup>/<sub>4</sub>" x 19 <sup>3</sup>/<sub>4</sub>"

## DELUXE

121



122



Massello con angolari in acciaio inossidabile 18/10  
Solid wood with 18/10 Stainless Steel legs  
Massif avec angle en inox 18/10  
Massivholz, Beine mit Edelstahl Rostfrei 18/10  
Profilen verblendet  
Tablero con angulares en acero inox 18/10

## VIP

126



127



Massello con angolari in massello  
Trolley and solid wood legs  
Panneaux massif avec angles et hanches massif  
Trolley und Beine komplett aus Massivholz  
Tablero macizo con angulares macizos

## COLORI

		121 126	122 127	
		Noce Walnut Noyer Walnuss Nuez	Wengè	

# TROLLEYS

## NIZZA



H cm 87  
cm 50 x 50

H 34 <sup>1</sup>/<sub>4</sub>"  
19 <sup>3</sup>/<sub>4</sub>" x 19 <sup>3</sup>/<sub>4</sub>"

## DELUXE

091



092



Massello con angolari e maniglioni in acciaio inossidabile 18/10  
Solid wood with 18/10 Stainless Steel handles and legs  
Massif avec arêtes et hanches en inox 18/10  
Massivholz, Beine mit Edelstahl Rostfrei 18/10 Profilen  
verblendet, Griffe 18/10  
Tablero con angulares y asas en acero inox 18/10

## COLORI

Questo carrello comprende un inserto avvitato sul piano ed il relativo secchiello per champagne, art. 599 + art. 589 (colore a vostra scelta).

This trolley includes a screwed insert onto the top and the relative champagne cooler, art. 599 + art. 589 (color to your choice).

Ce chariot comprend un supplément vissé sur l'étagère et le relatif seau à champagne, art. 599 + art. 589 (couleur à votre choix).

Dieser Trolley einschl. fixiertem Halter für Weinkühler, art. 599 einschl. Weinkühler mit Einsatz, art. 589 (Farben zu Ihrer Wunsch).

Esto carro comprende un legajo atornillado sobre el plan y el relativo cubo por champán, art. 599 + art. 589 (color a vuestra elección).

		091	092	
		Noce Walnut Noyer Walnuss Nuez	Wengè	

# TROLLEYS

## LAS VEGAS



H cm 83      H 32 3/4"  
cm 104 x 57      41" x 22 1/2"

## DELUXE

051



052



Massello con angolari e maniglioni in acciaio inossidabile 18/10  
Solid wood with 18/10 Stainless Steel handles and legs  
Massif avec arêtes et hanches en inox 18/10  
Massivholz, Beine mit Edelstahl Rostfrei 18/10 Profilen  
verblendet, Griffe 18/10  
Tablero con angulares y asas en acero inox 18/10

## VIP

056



057



Massello con angolari e maniglioni in massello  
Trolley and solid wood handles and legs  
Panneaux massif avec angles et hanches massif  
Trolley und Beine komplett aus Massivholz  
Tablero macizo con angulares y asas macizas

## COLORI

		051 056	052 057	
		Noce Walnut Noyer Walnuss Nuez	Wengè	

# TROLLEYS

## DALLAS



H cm 83      H 32 3/4"  
cm 104 x 57      41" x 22 1/2"

## DELUXE

041



042



Massello con angolari e maniglioni in acciaio inossidabile 18/10  
Solid wood with 18/10 Stainless Steel handles and legs  
Massif avec arêtes et hanches en inox 18/10  
Massivholz, Beine mit Edelstahl Rostfrei 18/10 Profilen  
verblendet, Griffe 18/10  
Tablero con angulares y asas en acero inox 18/10

## VIP

046



047



Massello con angolari e maniglioni in massello  
Trolley and solid wood handles and legs  
Panneaux massif avec angles et hanches massif  
Trolley und Beine komplett aus Massivholz  
Tablero macizo con angulares y asas macizas

## COLORI

		041 046	042 047	
		Noce Walnut Noyer Walnuss Nuez	Wengè	

# TROLLEYS

## MIAMI



H cm 82  
cm 80 x 91

H 32 1/4"  
31 1/2" x 35 7/8"

## DELUXE

106

107



Massello con angolari in acciaio inossidabile 18/10  
Solid wood with 18/10 Stainless Steel legs  
Massif avec angle en inox 18/10  
Massivholz, Beine mit Edelstahl Rostfrei 18/10  
Profilen verblendet  
Tablero con angulares en acero inox 18/10

## VIP

## COLORI

101

102



Massello con angolari in massello  
Trolley and solid wood legs  
Panneaux massif avec angles et hanches massif  
Trolley und Beine komplett aus Massivholz  
Tablero macizo con angulares macizos

		101 106	102 107	
		Noce Walnut Noyer Walnuss Nuez	Wengè	

# TROLLEYS



## MANIGLIA

Maniglione a scomparsa, regolabile in altezza, per la corretta postura della schiena durante la movimentazione.

## HANDLE

The foldaway handle can be ergonomically adjusted to the height of the user during transport.

## POIGNÉE

Poignée disparible, réglable en hauteur, pour la posture correcte du dos pendant le mouvements.

## SCHIEBEGRIFF

Der einklappbare Schiebegriff kann ergonomisch exakt auf die passende Höhe des Fahrers eingestellt werden, die er zum jeweiligen Transport benötigt.

## AGARRADOR

Agarrador abatible, ajustable en altura, para una correcta postura de la espalda durante el uso.



## HOT BOX

Contenitore Hot Box elettrico a 4 scomparti, con termostato regolabile fino a 90° C. Diametro massimo dei piatti inseribili: 31 cm.

## HOT BOX

Electric Hot Box compartment, 4 compartments with adjustable thermostat up to 194° F. Maximum inner dimension:: 12 1/4".

## HOT BOX

Récipient Hot Box électrique aux 4 compartiments, avec thermostat réglable jusqu'à 90° C. Maximum diamètre des plats insertables: 31 cms.

## HOT BOX

Elektrisch betriebene HOT BOX mit 4 Abteilungen, mit jeweils Nutzfläche bis zu 31 cm Durchmesser. Die HOT BOX ist ausgestattet mit einem regelbaren Thermostat bis zu 90° C.

## HOT BOX

Contenedor eléctrico de 4 compartimentos, con termostato ajustable a 90° C. Diámetro máximo de los platos insertables: 31 cm.



## PIANO SUPERIORE ESTENSIBILE

Piano superiore estensibile "a tavolino", massima estensione cm. 92 x 80

## EXTENDABLE UPPER SURFACE

Upper surface can be extended up to 36 1/4" x 31 1/2"

## PLAT SUPÉRIEUR EXTENSIBLE

Plat supérieur extensible, meilleure étendue cm. 92 x 80.

## AUSKLAPPBARE TISCHFLÄCHE

Die Tischfläche kann durch Ausklappen vergrößert werden auf das Mass von 92 x 80 cm.

## PLANO SUPERIOR EXTENSIBLE

Plano superior extensible, medida total extendida 92 x 80 cm.

# TROLLEYS



**SCOMPARTI**  
Scomparti portabottiglie e bicchieri.

**COMPARTMENTS**  
Compartments for wine bottles, glasses and stemware are also available.

**COMPARTIMENTS**  
Compartiments portebouteilles et verres.

**FÄCHER**  
Fächer für Weinflaschen, Becher und Stielgläser sind ebenfalls erhältlich.

**COMPARTIMENTOS**  
Compartimentos para botellas y vasos.



**CARATTERISTICHE**  
Alta resistenza, massima maneggevolezza, ruote maggiorate ed antistatiche.

**FEATURES**  
Durable oversized casters feature maximum maneuverability with non-tracking and non-conductive rubber wheels.

**CARACTÉRISTIQUES**  
Haute résistance, meilleure maniabilité, roues augmentées et antistatiques.

**BESONDERHEITEN**  
Die groß-dimensionierten, robusten Rollen aus antistatischem Gummi-Material erlauben eine hochgrade Beweglichkeit, selbst bei der Überwindung schwierigster Hindernisse und unterschiedlichsten Bödenbelägen.

**CARACTERÍSTICAS**  
Alta resistencia, máxima manejabilidad, ruedas grandes y antiestáticas.

**HOT BOX**  
Contentitore Hot Box elettrico a 4 scomparti, con termostato regolabile fino a 90° C. Diametro massimo dei piatti inseribili: 31 cm.

**HOT BOX**  
Electric Hot Box compartment, 4 compartments with adjustable thermostat up to 194° F. Maximum inner dimension:: 12 1/4".

**HOT BOX**  
Récipient Hot Box électrique aux 4 compartiments, avec thermostat réglable jusqu'à 90° C. Maximum diamètre des plats insertables: 31 cms.

**HOT BOX**  
Elektrisch betriebene HOT BOX mit 4 Abteilungen, mit jeweils Nutzfläche bis zu 31 cm Durchmesser. Die HOT BOX ist ausgestattet mit einem regelbaren Thermostat bis zu 90° C.

**HOT BOX**  
Contenedor eléctrico de 4 compartimentos, con termostato ajustable a 90° C. Diámetro máximo de los platos insertables: 31 cm.

110



## DELUXE - VIP



H cm 5,5

H 2 1/4"

Tutte le versioni Deluxe e Vip hanno la struttura in massello e il piano superiore in massello listellare. Colori optional: faggio, ciliegio, rovere e mogano.

All the wood components for the Deluxe and Vip versions are made from solid wood and the workspace top is made from heavy duty solid Block Wood Available colors: Beachwood, Cherry, Oak and Mahogany

Toutes les versions Deluxe et Vip ont la structure en massif et le plan supérieur en massif. Couleurs facultatif: Hêtre, Cerise, Chêne et Acajou.

Alle Ausführungen für die Deluxe- und VIP-Versionen sind hergestellt aus massivem Holz und die oberen Arbeitsbereiche aus strapazierfähigem, solidem Blockholz  
Verfügbare Farben: Buche, Kirsche, Eiche und Mahagoni

Todas las versiones "Deluxe" y "Vip" tienen la estructura en tablero macizo y el plano superior en tablero macizo listelar  
Colores disponibles: Haya, Cerezo, Roble y Caoba

## RICAMBI



cm 15,5 x 7,5  
H cm 2

6" x 2 7/8"  
H 1"

Piastre eutettiche senza evaporatore, disponibili per tutte le cupole: congelate a -21°C, durano fino a tre ore.

Eutectic cooling plates without evaporator are available for all of the roll-top covers. Refrigerated to -5,8°F, they will keep cool for approximately 3 hours.

Bacs eutectiques sans évaporateur, sont disponibles pour toutes les lavallières: réfrigérée à -21° C, ils durent jusqu'à trois heures.

Eutektische Kühlplatten ohne Verdampfer, für alle Roll-top Aufsatz erhältlich: vor dem Gebrauch, im Gefrierschrank mit -21°C abkühlen; damit verfügen Sie über 3 Stunden Kühlleistung.

Planchas eutecticas sin vaporizador, disponibles para todas las cúpulas: congeláis a -21°C, duran hasta tres horas.

## 800



H cm 29  
cm 11 x 11

H 11 3/8"  
4 1/2" x 4 1/2"

Campionario colore per sala esposizione  
Colori disponibili: noce, wengè, bianco, nero e oro.

Color Displayer for show room  
Available colors: walnut, wenge, gold, black and white.

Couleur Displayer pour show room  
Couleurs disponibles: Noyer, Wenge, Blanc, Noir et Or.

Farben Displayer für Show-Room  
Erhältliche Farben: Walnuss, Wenge, Weiss, Schwarz und Gold.

Color Displayer para sala de exposiciones  
Colores disponibles: Nogal, Wenge, Blanco, Negro y Oro.

## ACCESSORI

219



cm 83 x 36  
H cm 2

32 3/4" x 14 1/4"  
H 1"

Piano in marmo granito, perfettamente levigato e lucidato.

Perfectly ground and polished granite marble top surface.

Plan en marbre granulé, parfaitement lissé et poli.

Polierte Granit-Marmor-Platte mit perfekt glatt geschliffener Oberfläche.

Plano en mármol granito, perfectamente pulido.

# TROLLEYS

## PARIS



Cupola refrigerata con piano in marmo  
Cool roll-top cover with marble tray  
Lavallière réfrigéré avec bac eutectiques et plateau en marbre  
Kühl-Rolltop-Aufsatz mit Marmorplatte  
Cúpula refrigerada con plano en mármol

H cm 26,5  
cm 92 x 47

H 10 1/2"  
36 1/2" x 18 1/2"

## DELUXE

161

162

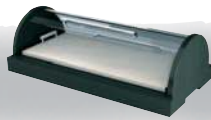

Massello  
Solid wood  
Massif  
Massivholz  
Tablero macizo

## 225

## COLORI



- 2 Piastre eutettiche senza evaporatore sono già inserite nella cupola refrigerata
- 2 Eutectic cooling plates without evaporator are already inserted into the roll-top cover
- 2 Bacs eutectiques sans évaporateur sont déjà insérés dans la lavallière
- 2 Bereits eingelegte Kühlaccus gehören mit zum Lieferumfang
- 2 Planchas eutecticas sin vaporizador son ya insertadas en la cúpula refrigerada

		161	162	
		Noce Walnut Noyer Walnuss Nuez	Wengè	

## WIEN

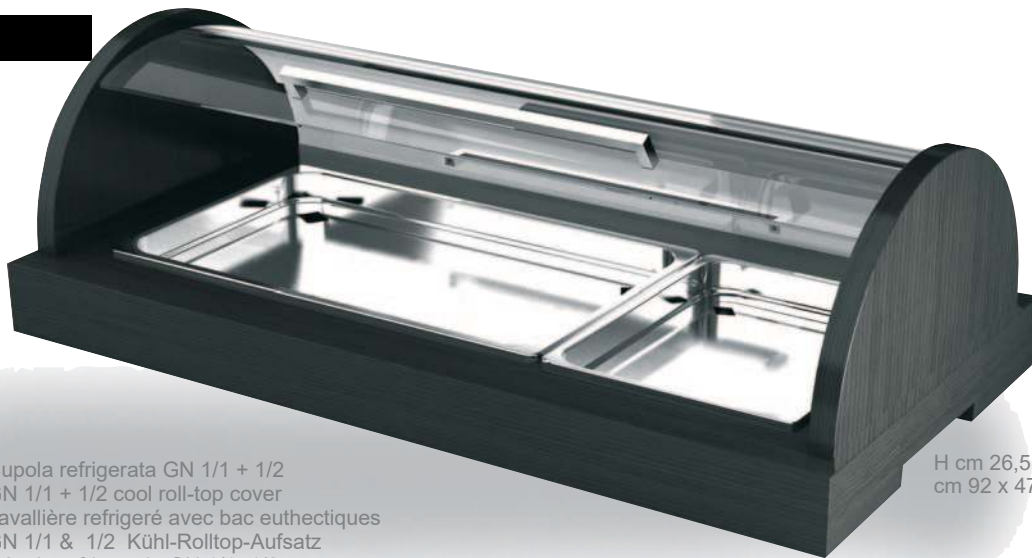

Cupola refrigerata GN 1/1 + 1/2  
 GN 1/1 + 1/2 cool roll-top cover  
 Lavallière réfrigéré avec bac eutectiques  
 GN 1/1 & 1/2 Kühl-Rolltop-Aufsatz  
 Cúpula refrigerada GN 1/1 -1/2

H cm 26,5  
 cm 92 x 47

H 10 1/2"  
 36 1/4" x 18 1/2"

## DELUXE

141

142



Massello  
 Solid wood  
 Massif  
 Massivholz  
 Tablero macizo

## 225

## COLORI



- 2 Piastre eutettiche senza evaporatore sono già inserite nella cupola refrigerata
- 2 Eutectic cooling plates without evaporator are already inserted into the roll-top cover
- 2 Bacs eutectiques sans évaporateur sont déjà insérés dans la lavallière
- 2 Bereits eingelegte Kühlaccus gehören mit zum Lieferumfang
- 2 Planchas eutecticas sin vaporizador son ya insertadas en la cúpula refrigerada

		141	142	
		Noce Walnut Noyer Walnuss Nuez	Wengè	

# TROLLEYS

TEVERE



H cm 80      H 31 1/2"  
cm 80 x 40    31 1/2" x 15 3/4"

302



Pannello nobilitato in essenza  
Laminated panel  
Panneaux noble  
Lackierte Paneele  
Tablero lacado

309



Pannello nobilitato in essenza  
Laminated panel  
Panneaux noble  
Lackierte Paneele  
Tablero lacado

COLORI

302		309
Wengè		Castagno chiaro Light chestnut Châtain clair Heile Kastanie Castaño claro

# TROLLEYS

## MISSISSIPPI



H cm 85  
cm 98 x 57

H 33 1/2"  
38 3/8" x 22 3/8"

## 332



Pannello nobilitato in essenza  
Laminated panel  
Panneaux noble  
Lackierte Paneele  
Tablero lacado

## 339



Pannello nobilitato in essenza  
Laminated panel  
Panneaux noble  
Lackierte Paneele  
Tablero lacado

## COLORI

332		339
Wengè		Castagno chiaro Light chestnut Châtain clair Heile Kastanie Castaño claro

# TROLLEYS

RENO



H cm 85      H 33 1/2"  
cm 50 x 50    19 3/4" x 19 3/4"

322



Pannello nobilitato in essenza  
Laminated panel  
Panneaux noble  
Lackierte Paneele  
Tablero lacado

329



Pannello nobilitato in essenza  
Laminated panel  
Panneaux noble  
Lackierte Paneele  
Tablero lacado

COLORI

322		329
Wengè		Castagno chiaro Light chestnut Châtain clair Heile Kastanie Castaño claro

**Alta resistenza al graffio per il normale utilizzo**

High resistance to scratch for normal use  
 Hautes résistance aux griffures  
 Kratzfest bei normalem Gebrauch.  
 Alta resistencia a las rayas resultantes del uso normal

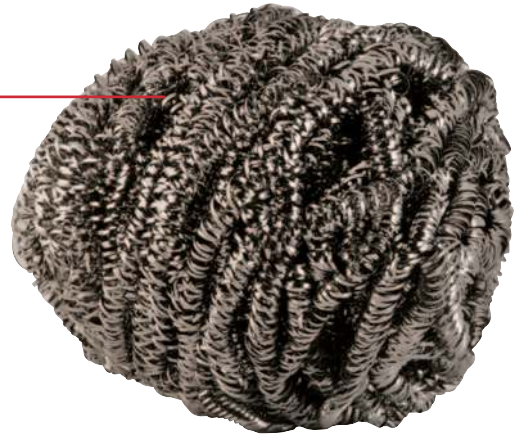
**Idrorepellente non cambia colore a contatto con liquidi e cibi**

Hydro repellent, it doesn't change colour when in contact with liquids or foods.  
 Matière ne subissant aucunes agressions exterieurs, liquide et autres.....  
 Wasserfest, keine Farbveränderung bei Kontakt mit Flüssigkeiten oder Esswaren.  
 Repelente al agua, no cambia de color al entrar en contacto con líquidos y alimentos.

**Ruote speciali a grandezza maggiorata, fascia in gomma antistatica e antitraccia.  
Ruote e struttura potenziate ad alta portata**

The oversized wheels are antistatic, won't leave marks.  
 Wheels and enhanced high-range structure.  
 Roulettes surdimensionnées spéciales, avec bande en caoutchouc synthétique conducteur antitrace.  
 Roues et roulements adaptées en fonction du poids de la table roulante.  
 Besonders grossdimensionierte Rollen mit antistatischen Gummireifen, die keinen Abrieb hinterlassen.  
 Die Rollen und das Gefüge verstärkte sind, um grössere Fähigkeit zu tragen.  
 Ruedas especiales de mayor tamaño, con cinta de goma antistatica y antihuellas.  
 Ruedas y estructura mejoradas de alta capacidad.





# Ambiente Environment



Da molti anni MEPRA ha a cuore la salute dell'ambiente e dei lavoratori e l'uso sostenibile delle risorse ambientali, spesso anticipando di decenni le normative europee sul lavoro e sull'ambiente, investendo e puntando su impianti sempre più sicuri, alla ricerca di materiali e prodotti ausiliari sempre meno pericolosi, a garanzia della sicurezza e della salute del personale addetto e della comunità all'interno della quale l'azienda opera. Nei primi anni '80 del secolo scorso, gli impianti di lavaggio dei manufatti intermedi e finiti che utilizzavano solventi clorurati, vengono interamente rimpiazzati da impianti automatici che utilizzano sgrassanti a base acquosa (tunnel di lavaggio a tappeto). Nello stesso periodo gli impianti di pulitura e lucidatura della posateria manuali, vengono sostituiti da macchinari automatici a ciclo continuo, dotati di impianti di aspirazione e di abbattimento polveri. Negli anni '90, MEPRA, sempre più attenta alle tematiche ecologiche, trasforma i suoi impianti di lavaggio con soluzioni sgrassanti a base acquosa, che utilizzano e scaricano l'acqua per il lavaggio dei pezzi, in impianti che riciclano interamente le acque di lavaggio, filtrandole e re-immettendole nel ciclo senza alcuno scarico negli impianti fognari. Nel 1999 MEPRA con spirito innovativo si proietta verso il futuro, dotandosi di un sistema energetico altamente tecnologico; viene infatti installato un impianto di COGENERAZIONE. Viene utilizzato il metano come combustibile pulito, si genera elettricità per l'uso interno, si recupera il calore sprigionato dalla produzione elettrica, per il riscaldamento dei cicli produttivi che assorbono calore ed inoltre per il riscaldamento ambientale durante l'inverno, in modo da diminuire drasticamente l'inquinamento atmosferico prodotto dai gas serra. MEPRA rifiuta categoricamente ogni forma di sfruttamento del lavoro minorile ed investe ogni giorno per offrire alle nuove generazioni un futuro migliore, collaborando con le università e le scuole secondarie della comunità locale per formare i manager e i tecnici del futuro e per sostenere il mantenimento e l'accrescimento della cultura del lavoro, dei valori e delle competenze professionali che rappresentano una delle caratteristiche peculiari del distretto industriale all'interno del quale l'azienda opera.

Since many years MEPRA cares about the health of workers and the environment and sustainable use of environmental resources, often decades ahead of European regulations on labor and environment. Mepra invests and focus on safer and safer equipments, looking for materials and auxiliary products less and less dangerous, to guarantee safety and health of the workers as well as the community within which it operates. In the early 80s of last century, the washing equipment, previously based on chlorinated solvents, are entirely replaced by automatic systems that use water-based washing tunnels. In the same period the hand operated cutlery cleaning and polishing machineries, are replaced by continuous loop automatic machines, equipped with suction pumps and dust abatement equipment. In the '90s, MEPRA, more and more careful about the environment, converts washing systems previously using water-based degreasing solutions that were filtered and discharged into the sewers, into equipments that recycle the wastewaters by filtering and re-pumping them in the washing cycle without any waste in sewage plants. MEPRA in 1999 with an innovative spirit is projected into the future, adopting a high-tech energy system, a cogeneration system is in fact installed. It uses natural gas as clean fuel, electricity can be generated for internal use, it re-uses the heat generated from electricity production in production cycles and also for heating the plant during the winter, in order to drastically reduce carbon emissions. MEPRA categorically rejects all forms of child labor and invest every day to offer the new generations a better future, working with universities and secondary schools in the local community to train managers and technicians of the future and to carry-on work culture, values and skills that represent one of the characteristics of the industrial district in which the company operates.



# CERTIFICATO DI SISTEMA DI GESTIONE

Certificato n.  
1000031372.MSC-ACCREDIA-ITA

Data Prima Emisione:  
28 agosto 2023

Validità:  
28 agosto 2023 - 27 agosto 2026

Si certifica che il sistema di gestione di  
**Mepra S.p.A.**  
Via Virgilio Montini, 176 - 25067 Lumezzane (BS) - Italia

È conforme allo Standard:  
**ISO 9001:2015**

Questa certificazione è valida per il seguente campo applicativo:  
**Progettazione, produzione e commercializzazione di: posateria, pentolame, vasellame ed oggettistica in acciaio inox per la tavola e la cucina per uso domestico, Hotel, Ristoranti e Catering (IAF 17)**

Luogo e Data:  
Vimercate (MB), 11 agosto 2023



1000031372.MSC-ACCREDIA-ITA  
1000031372.MSC-ACCREDIA-ITA  
1000031372.MSC-ACCREDIA-ITA  
1000031372.MSC-ACCREDIA-ITA  
1000031372.MSC-ACCREDIA-ITA  
1000031372.MSC-ACCREDIA-ITA  
1000031372.MSC-ACCREDIA-ITA  
1000031372.MSC-ACCREDIA-ITA  
1000031372.MSC-ACCREDIA-ITA  
1000031372.MSC-ACCREDIA-ITA

Per l'Organismo di Certificazione:  
**DNV - Business Assurance**  
Via Energy Park, 14 - 20871 Vimercate (MB) - Italy

*Claudia Baroncini*

**Claudia Baroncini**  
Management Representative

Il mancato rispetto delle condizioni stabilite nel regolamento di certificazione potrebbe invalidare il certificato.



# MANAGEMENT SYSTEM CERTIFICATE

Certificate no.  
1000031372.MSC-ACCREDIA-ITA

Initial certification date:  
28 August 2023

Valid:  
28 August 2023 - 27 August 2026

This is to certify that the management system of  
**Mepra S.p.A.**  
Via Virgilio Montini, 176 - 25066 Lumezzane (BS) - Italy

has been found to conform to the Quality Management System standard:  
**ISO 9001:2015**

This certificate is valid for the following scope:  
**Design, production and commercialization of: flatware, cookware, serverware and items in stainless steel for the table and kitchen for domestic use, Hotels, Restaurants and Catering (IAF 17)**

Place and date:  
Vimercate (MB), 11 August 2023



1000031372.MSC-ACCREDIA-ITA  
1000031372.MSC-ACCREDIA-ITA  
1000031372.MSC-ACCREDIA-ITA  
1000031372.MSC-ACCREDIA-ITA  
1000031372.MSC-ACCREDIA-ITA  
1000031372.MSC-ACCREDIA-ITA  
1000031372.MSC-ACCREDIA-ITA  
1000031372.MSC-ACCREDIA-ITA  
1000031372.MSC-ACCREDIA-ITA  
1000031372.MSC-ACCREDIA-ITA

For the issuing office:  
**DNV - Business Assurance**  
Via Energy Park, 14 - 20871 Vimercate (MB) - Italy

*Claudia Baroncini*

**Claudia Baroncini**  
Management Representative

Lack of fulfillment of conditions as set out in the Certification Agreement may render this Certificate invalid.  
ACCREDITED UNIT: DNV Business Assurance Italy S.r.l. - Via Energy Park, 14 - 20871 Vimercate (MB) - Italy - TEL: +39 03 91 901 - www.dnv.it

**Abbiamo a cuore l'ambiente e il futuro del genere umano**  
Sin dal 1947 Mepra si trova ai piedi delle Prealpi Italiane. Siamo cresciuti e viviamo ogni giorno in simbiosi con le nostre montagne, abbiamo a cuore i nostri alberi, le nostre acque e l'aria che noi e i nostri figli respiriamo.

Nella lotta al cambiamento climatico ogni voce conta, anche la più piccola, in ogni angolo del mondo, e sentiamo la responsabilità di fare la nostra parte per assicurare un futuro migliore al pianeta.

#### **Riduzione delle Emissioni di CO2**

Con l'obiettivo di ridurre drasticamente le emissioni di CO2 Mepra si è impegnata ad installare un impianto fotovoltaico per produrre oltre 160.000 KWh all'anno e ridurre di conseguenza le emissioni di CO2 di 84.000 Kg. Il fabbisogno energetico residuo, nei mesi invernali, viene prodotto, per la maggior parte, con un sistema di cogenerazione. Questo impianto produce elettricità e, allo stesso tempo, il calore necessario per il riscaldamento dei locali aziendali, con un significativo risparmio energetico.

#### **Riciclo**

La maggior parte dell'acciaio utilizzato da Mepra nel processo produttivo proviene da fonti riciclate

Tutto lo scarto di produzione viene riciclato per produrre nuova materia prima

#### **Gestione e recupero dei rifiuti**

Mepra è da anni impegnata nella raccolta differenziata, non solo degli imballaggi, ma di tutti i rifiuti prodotti in azienda.

#### **Conservazione delle risorse idriche**

Dai primi anni '90 Mepra utilizza, all'interno del suo ciclo produttivo, un sistema di recupero dell'acqua di lavaggio e dei detergenti che vengono filtrati e re-immessi nel ciclo idrico senza alcuno scarico negli impianti fognari.

#### **Utilizzo di sostanze non inquinanti:**

Già dai primi anni '80, gli impianti di lavaggio dei manufatti intermedi e finiti che utilizzavano solventi clorurati, sono stati interamente rimpiazzati da impianti automatici che utilizzano sgrassanti a base acquosa (tunnel di lavaggio a tappeto).

#### **Depurazione dell'aria**

Nello stesso periodo gli impianti manuali di pulitura e lucidatura della posateria, sono stati sostituiti da macchinari automatici a ciclo continuo, dotati di impianti di aspirazione e di abbattimento polveri.

#### **We have the future of the environment and the human species at heart**

Since 1947 Mepra has been located at the foothill of the Italian pre Alps. We grew with and live in symbiosis with our mountains, day in day out, we care for our trees, our waters and the air we and our children breathe. In the fight against climate change every voice counts, even the faintest one, in every corner of the earth, and we feel the responsibility to play our part to ensure a better future for our planet.

#### **Reduction of CO2 emissions**

In the quest of drastically reducing CO2 emissions, Mepra has been working hard on the installation of a photovoltaic plant to produce more than 160.000 KWh per year, thus reducing CO2 emissions by 84.000 Kg.

The residual energy requirement in the winter months is produced for the most part by a cogeneration system that at the same time produces electricity and the necessary heat to heat up the offices, resulting in a significant energy saving.

#### **Recycling**

The majority of the steel used by Mepra in the production process comes from recycled sources. All the production waste is recycled to produce new raw material.

#### **Waste management and recovery**

For years Mepra has been practicing differentiated waste collection, not only with packaging, but all waste produced by the company.

#### **Conservation of water resources**

Since the early '90s Mepra uses a system that recovers the washing water and detergents used in production, by filtering them and re-introducing them in the water cycle without any discharge into the sewage system.

#### **Use of non-polluting substances**

Since the beginning of the 80's the washing machinery of the intermediate or finished products that used chlorinated solvents have entirely been replaced by automated machinery that use water-based degreasers.

#### **Air purification**

Always in the 80's the cleaning and polishing machinery used for cutlery have been replaced by automated loop machines equipped with dust suction and elimination systems.

B O B

# BOB

AIUTA IL NOSTRO PIANETA  
RIDUCI LA PLASTICA

Abbiamo creato una nuova linea di bottiglie riutilizzabili per garantire un futuro ai nostri oceani.

Per questo motivo il nome 'BOB = Blue Ocean Bottle', un progetto che ci aiuterà a ridurre l'utilizzo della plastica eliminando il consumo di bottiglie quotidiane.

BOB non è una semplice bottiglia termica, è l'esempio perfetto di utilità e eleganza fusi insieme.

We have created a new line of reusable bottles to grant a future to our oceans.

Hence the name "BOB = Blue Ocean Bottle", a project that will help us reduce the use of plastic by eliminating the consumption of daily plastic bottles. BOB is not a simple thermal bottle, it is the perfect example of utility and elegance fused together.

## Perchè scegliere BOB? Why BOB?



Aiuta la salvaguardia dei nostri oceani.  
Helps safeguard of our oceans.



Ferma il single use delle bottiglie di plastica.  
Stops the single use of plastic bottles.



Diminuisce i batteri ingeriti che si annidano nelle bottiglie di plastica.  
Reduces the ingested bacteria lurking in plastic bottles.



Durabilità nel tempo.  
Longevity over time



Grazie al suo molteplici utilizzo, è un'ottima scelta per risparmiare denaro.  
Can be used multiple times and is an excellent way to save money.



# BLUE OCEAN BOTTLE

BOB è una bottiglia termica di capacità 0,5 litri. Grazie alla doppia camera in acciaio inossidabile, mantiene la temperatura della bevanda calda 12h e fredda fino a 24h.

BOB è in grado di contenere qualsiasi bevanda, dall'acqua ai succhi di frutta, senza rischio di corrosioni o alterazioni.

BOB is a thermal bottle with 0.5 liter capacity . Thanks to its double stainless steel chamber, it keeps the hot temperature for 12 hours and the cold one for up to 24 hours.

BOB is able to hold any drink, from water to fruit juices, without the risk of corrosion or alterations.



**Chiusura Termica**

Thermal Closure

**Bilaminato acciaio e rame**

Bi-laminated steel and copper

**Camera sotto vuoto**

Vacuum room

**Corpo esterno di protezione**

External protection body

**Triplo fondo**

Triple bottom



COLORI DISPONIBILI  
 AVAILABLE COLORS  
 COULEURS DISPONIBLE  
 VERFÜGBARE FARBEN  
 COLORES DISPONIBLE:

W  
 Bianco  
 White  
 Blanc  
 Weiss  
 Blanco



O7  
 Arancio  
 Orange  
 Orange  
 Orange  
 Naranja



S7  
 Rosso  
 Red  
 Rouge  
 Rot  
 Rojo



693

BOB  
 Bottiglia termica  
 Insulated bottle  
 Bouteille thermique  
 Isolier Flasche  
 Botella térmica

lt. 0,5  
 oz. 16 7/8

H7  
 Lilla  
 Lilac  
 Lilas  
 Lila  
 Lila



Q7  
 Oliva  
 Olive  
 green  
 Olive  
 Olivegrün  
 Oliva



D7  
 Lavanda  
 Lavendal  
 Lavande  
 Lavendal  
 Lavanda



O  
 Oro  
 Gold  
 Or  
 Gold  
 Oro



B  
 Rame  
 Copper  
 Cuivre  
 Kupfer  
 Cobre



N  
 Nero  
 Black  
 Noir  
 Schwarz  
 Negro



You can save the oceans too, one bottle at a time!





INDICE

INDEX

INDEX

ALPHABETISCHES REGISTER

INDICE

NUMERI

RESTAURANT  
HOTEL

# Indice

A B	Pag
Agitatore	301
Agitatore Boston	301
Allacciatovaglioli	130 259
Alzata dolci	173 177 216 217 220 221 227 266 288
Alzata pane	234 235 289
Alzata pesce crudo	158 159 160 223 231
Alzata portafrutta	158 159 216 217 220 231 266
Alzata portapiatti	221 287
Alzata torta	173 177 216 230 266
Ampolla	219 239 242 268
Antipastiera	248 258
Appoggia borse	284
Appoggia chop sticks	82
Appoggia posate	84 102 173 177 195 209
Apribottiglie	282
Apriostriche	160
Base per buffet	196 197
Bicchiere	154 178 202 206 340 341 346
Big champagnera	310
Bistecchiera	333
Bollilatte	337
Bottiglia termica	368 <> 371
Braciere con griglia	242 244
Bricco	147 293
Brocca per acqua	294 0
Bugia	227 0

C	Pag
Caffettiera	220 291 292 294 295 296
Caffettiera termica	291 292 296
Candelabro	221 227
Caraffa per bibite	199 291 292 294
Caraffa termica	291 292
Carrello portavivande	348 <> 362
Casseruola	322 324 326 331 334
Cavatappi	282
Centrotavola	155 158 159 161 189 202
Cestino	125 126 128 129 130 135 146 149 150 151 152 153 155 172 174 176 177 182 186 193 195 202 218 234 235 237 259 262 263 265 280 342 346
Cestino portabonbon	180 182 265
Cestino portacondimenti	135 262 277 280
Cestino portafrutta	135 146 149 150 151 152 153 155 234 237 262 265 308 309 342 346
Cestino portapane	135 146 149 150 151 186 193 195 218 234 235 237 259 262 265 280 342
Cestino portatovaglioli	193 234 289 298
Cesto porta agrumi	135 146 149 150 151 152 153 155 234 237 262 265 308 309 342 346
Chafing dish	208 210
Champagnera	152 223 233 310 314 315
Chillcup	219 238
Chop sticks	82
Ciambella termica	249 251
Ciotola in acciaio	146 216 237 277
Ciotola in legno	277
Ciotola in policarbonato	135 309 310 340 342 343
Ciotola in polipropilene	346
Cloche	221 223 224 236 251 273 276 281
Coffee Urn	209
Colapasta	337
Colino da cocktail	282
Colonna porta big champagnera	311
Colonna portasecchiello	126 128 135 153 222 232 233 302 303 304 305 306 307 309 315
Colonna portasigari	154
Coltelli	14 <> 72 86 88 104 118 160 243
Contenitore per bibite	199 209
Coperchio	224 272 274
Coperchio per legumiera e zuppiera	224 274
Coperchio per piatto ovale	272
Coppa burro	219 238
Coppa caviale	219 238
Coppa cocktail e scampi	219 238
Coppa con piede	146 147 216 218 223 237 301
Coppa con vassoio	178 180 182 219 225 238
Coppa crema/potage	274
Coppa intermezzo	100 278
Coppa in vetro	218 249
Coppa lavadita	146 276
Coppa Martini	278 341
Coppa multiservizio	218
Coppa per champagne	223 227 301
Coppa per gelato e/o macedonia	147 180 182 225 237 238 280 288 341
Coppa per pinzimonio	218 249
Coppa per punch	223 227 301
Coppa vichyssoise	219 238 274
Coppetta amouse bouche	102 178
Copripiatto	270 273
Cremiera	154 248 288 299

C	Pag
Cubetto luminoso LED	317
Cucchiaino da cocktail	14 <> 72 102 206
Cucchiaino per cappuccino	104 299
Cucchiaino per caviale	282
Cucchiaino sale	102 206
Cucchiaino agitatore	14 <> 72 104 106 299 316
Cucchiaino monoporzione	102 206
Cucchiaino multifunzione	96 163
Cucchiaino per bibita	14 <> 72 104 106 299 316
Cucchiaino per insalata	14 <> 72 106 119 209 210
Cucchiaino per miele	98
Cucchiaino per parmigiano	14 <> 72
Cucchiaino per risotto	104 106 119 209 210
Cucchiaino per salsa	14 <> 72 119 210 274
Cucchiaino servire	14 <> 72 104 106 119 209 210
Culla porta champagne	211
Cuocipasta	337
Cuociverdura	337

DEF	Pag
Distributore di latte	209
Distributore di succo di frutta	209
Dosatore sale e pepe	154
Dosatore	301
Espositore per buffet	202
Finger food	102 106 133 162 <> 167 172 176 185 195 202 206 212 94 104
Forchetta aragosta	94 104
Forchetta monoporzione	102 172 176 206
Forchetta per insalata	14 <> 72 106 119 209 210
Forchetta per lumache	104
Forchetta servire	14 <> 72 104 106 119 209 210
Forchetta servire pesce	14 <> 72 106 119
Forchettina ostriche	14 <> 72
Forchettina cocktail	102 172 176 206
Forchettone	14 <> 72 104 106 119 209 210
Formaggiera	133 219 239 259 260 262 263 265 269 276
Fruttiera	155 158 159 161 189

GHIL	Pag
Glacette termica	304
Golf club mixer spoon	104 316
Grattugia	282
Gueridon d'appoggio	308
Happy spoon	106
Infusiera	199
Inserto per cuocipasta	337
Insalatiera	146 216 237 249 342 346
Inserto per finger food	133 165
Lasagnera	249 258
Lattiera	220 291 292 294 295 296
Legumiera	224 274
Legumiera escoffier	274

MNO	Pag
Macine	283
Mestolo	14 <> 72 106 210 301
Micro forchetta	102 172 176
Micro presentoire	163 288
Mini barriera	144 225 239 264 267 277 288
Mini casseruola	322 324 326
Mini cestello	177
Mini forchetta	102 206
Mini presentoire	163 288
Mini spoon	102 206
Mini vaporiera	166
Mini vassoio	164 181 182 183 202 220
Misurino cocktail	301
Molla fonda per servire	212
Molla per aperitivi	212 293
Molla per asparagi	147 212 275
Molla per arrosto e verdure	147 212 275
Molla per dolci	212 275
Molla per Finger Food	212
Molla per frutta	212 275
Molla per ghiaccio	212 275 316
Molla per ghiaccio e limone	212
Molla per lumache	104 275 276
Molla per pane	212
Molla per pasticceria	212
Molla per servire	212 275
Molla per spaghetti	147 212 275
Molla per zucchero	212 275 293
Molla per zucchero ed aperitivi	212 293
Molla piana per servire	212
Mug	343
Numero da tavola	185 223 237 278 281
Oliera	133 225 239 259 260 262 263 265 268 269

PQR	Pag
Padella	323 325 327 331 332 336
Pala per torta	14 <> 72 106 118 209 210
Pentola	322 324 326 331 334
Petit marmite	208

# Indice

P Q R	Pag
Piano	130 149 150 151 189 202 206 340
Piastra ad induzione ed elettrica	208
Piastra eutettica	358 359
Piattino	171 176 238 343
Piattino per burro	264 267
Piattino per lumache	276
Piattino per mug	343
Piattino per pane	149 267
Piattino per pasticceria	179 181 182
Piattino porta monete	176 301
Piattino sottocoppa	238
Piatto concavo	193 235
Piatto da presentazione	134 146 149 151 165 186 194 257 263 264 266 283 346
Piatto da torta	218 230
Piatto ovale	144 146 270 272
Piatto per buffet	340
Piatto per legumi	146 272
Piatto per ostriche	158 159 161
Piatto pesce	144 270
Piatto quadrato	150 202 248
Piatto rotondo	144 146 206 251 270 272 340
Piatto termico	251
Pietra ollare	242
Pinza aragosta	104
Pinza per antipasti e dolci	212 275 293
Pinza per dolci	212 275
Pinza per servire	147 212 275
Pinza per torta	212 275
Pinza per verdure	147 212 275
Pirofile e porcellane	249 258
Poggia pane	178
Porta badge	281
Porta bastoncini di zucchero	298
Porta bicchieri	259
Porta bottiglie	277 279
Porta burro e marmellata	277 299
Porta bustine da zucchero	193 220 234 289 296 298 299
Porta cannuce	316
Porta condimenti	135 262 277 280
Porta cono gelato	165 242
Porta crackers	178
Porta cucchiaini	301
Porta gioie	170 176
Porta grissini	151 178 186 193 195 279
Porta macarons	219 267 288
Porta marmellata	225 269 299
Porta menù	223 237
Porta noccioli	133 236
Porta numero	185 223 237 278 281
Porta pane porta grissini	151 178 185 186 193 195 279
Porta pasticcini	216 217 227 266 288
Porta patatine fritte	165 242 278
Porta piatti	221 259 287
Porta salatini	219 287 342 343
Porta salse	280
Porta salviettine	299
Porta sapone	299
Porta sigari	154
Porta sorpresa	170 176
Porta spazzolini	301
Porta spezie	258
Porta stuzzicadenti	185 195 219 225 234 239 268 269 274 280
Porta tacos	279
Porta toast	278 288
Porta tovaglioli	192 193 234 258 289 298
Porta uovo	144 277
Porta vivande	208 210
Portaghiaccio termico	232 304 305 306
Posacenere	151 154 276
Posate	14 <> 72 86 88 96 98 102 104 106 118 119 160 163 176 206 209 210 243 274 282 299 301
Presentoire	163 221 227 287 288 289
Quarta posata	90 <> 93 163 175
Rechaud	208 210
Rinfresca macedonia	223
Rinfrescatore per yogurt	210 223
Rinfrescavino bianco	304 305 307
Risottiera	258 320 324 326 331 333

## S

Salino	219 269
Salsiera	144 274
Salvagoccia	279
Saucière	144 178
Sauteuse	246
Schiaccianoci	282
Scodella lavadita	146 276
Secchiello per ghiaccio	146 152 153 222 232 301 302 303 304 305 306 308 314 316 317 346
Secchiello per ghiaccio termico	232 304 305 306
Secchiello per spumante	126 146 152 153 186 222 232 301 302 303 304 305 306 307 308 309 310 314 316 317 342 346

## S

S	Pag
Segnaposto	278
Servizio per antipasto	219
Servizio per caffè	224 293
Servizio per caviale	238
Servizio per champagne	305
Servizio per latte macchiato	299
Servizio per olio e aceto	262 277 280
Servizio per pinzimonio	249
Servizio per zucchero	225 267 287 293
Set impilabile	342 343
Set per aperitivi	133
Set per ceviche	281
Set sale e pepe	154 225 239 268 269 274
Sottobicchiere	257 264 267
Sottobottiglia	185 186 195 257 264 267 283
Sottopiatto	134 146 149 151 165 186 194 257 263 264 266 283 346
Spaghettiera	337
Spargipepe	154
Spargisale	154 219 225 239 268 269 274
Spumantiera	152 233 310 314 315
Street cover	138 140
Supporto	248 249
Supporto per informazioni	223 237

## T V W Z

Taglia tartufi	283
Tazza	343
Tegame	320 324 326 331 333 334
Tegamino friggiuova	147 276
Teiera	220 291 292 294 295 296
Teiera termica	296
Tiffin' box	252
Tovaglietta americana	134 138 140 185 194
Trolley	348 <> 363
Tube per ghiaccio	199
Tumbler	178
Vaporiera	166
Vasetto portafiori	283
Vaso	171 176 346
Vassoietto	181 182 183 220
Vassoio	123 133 134 144 150 158 159 161 164 165 175 177 179 180 181 182 185 186 189 192 194 195 202 206 209 215 218 228 229 230 234 235 236 254 257 260 262 263 264 272 273 279 280 288 289 298
Vassoio concavo	279
Vassoio conto	151
Vassoio gn	185 186 194 215 228
Vassoio in carbonio	122 123
Vassoio ovale	150 159 164 189 218 230 263 273
Vassoio per carrelli	186 235 254
Vassoio petit four	179 180 181 182 183
Vassoio portabicchieri impilabile	235
Vassoio prima colazione	133
Vassoio quadrato	134 150 158 164 165 185 195 202 229 257 262
Vassoio rettangolare	123 133 134 144 150 158 164 185 186 189 192 194 195 202 206 209 215 218 228 229 230 234 235 236 254 257 260 262 263 264 272 273 279 280 288 289 298
Vassoio rotondo	159 161 175 177 215 218 229 230 236 257 260 264
Versatore per profumo	225
Vetrina (cupola) refrigerata	358 359
Wok	333 337
Zuccheriera	147 154 220 291 292 294 295 296 298 299
Zuppiera	208 224 274
Zuppiera monoporzione	274

# Index

## A B

	Pag
Accessories	82 <> 107
Afternoon tea stand	221 287
Amenities tray	133 134 135 165 186 234 289 299
Appetizer bowl	133 178
Appetizer set	133
Asparagus tongs	147 212 275
Bags support	284 285
Bar spoon	104 106 299 316
Basket for aromatic condiments	260 277 280
Beverage server	199 291 292 293 294
Beverage server, insulated	291 292
Big wine party tub	152 223 233 310 314 315
Boston shaker	301
Bottle cooler	304
Bottle, insulated	368 <> 371
Bottle opener	282
Bottle stand/coaster	185 186 195 254 262 264 283
Bowl	146 149 150 151 177 178 182 202 216 218 225 235 237 259 277 309 340 342 343 346 309 310 342
Bowl, small	102 146 178 180 216 218 237 277 342 343 346
Bread basket	135 146 149 150 151 186 193 195 218 234 235 237 259 262 265 280 342
Bread plate	149 267
Bread stand	192 234 289
Bread/Pastry tongs	212
Breakfast tray	133
Buffet rack	202 340
Buffet showcase, cooled	358 359
Butter cup and dish	219 238 264 267 277 299

## C

Caf� au lait set	224 293 299
Cake server	14 <> 72 106 118 209 210
Cake stand	173 177 216 217 220 221 227 266 288
Candlestick	221 227
Carbon fiber tray	122 123
Carving fork	16 <> 72 104 119
Cash tray	176 301
Caviar cup	219 238
Caviar set	238
Caviar spoon	282
Casserole	322 324 326 331 334
Centerpiece	155 158 159 161 189 202
Ceviche set	281
Chafing dish	208 210
Champagne bowl	152 223 233 310 314 315
Champagne bowl stand	126 128 135 153 222 232 233 302 303 304 305 306 307 309 315
Champagne bucket	126 146 152 153 186 222 232 301 302 303 304 305 306 307 308 309 310 314 316 317 342 346
Champagne holder	211
Charger	134 146 149 151 165 186 194 257 263 264 266 283 346
Chillcup	219 238
Chilli mill	283
Chips cone holder	165 240 278
Chopsticks	82
Chopsticks rest	82
Cigar ash tray	151 154 276
Cloche	221 223 224 236 251 273 276 281
Cloche for wedding cake stand	224 236 281
Cocktail measuring cup double	301
Cocktail strainer	282
Coffee cup	343
Coffee dispenser solid alcohol heating	209
Coffee pot	220 291 292 294 295 296
Coffee pot, insulated	291 292 296
Coffee urn	209
Colander	337
Cookware	318 <> 337
Cooled juice pitcher	291 292 294
Cork screwer	282
Cover	270 273
Cover for oval meat dish	270
Cover for soup tureen and vegetable dish	270 272 273
Creamer	154 248 288 299
Cruet	219 239 242 268
Cruet set	135 225 239 259 260 261 262 263 265 268 269
Cup and tray	178 180 182 219 225 238
Cup with feet	146 147 216 218 223 237 301

## DEF

Deep serving tongs	275
Dish cover	270 273
Dome cover for dish	221 223 224 236 251 273 276 281
Egg cup	144 277
Electric heating unit	208
Escargot fork	104
Escargot plate	276

## DEF

Escargot tongs	104 275 276
Eutectic pads	357 358
Finger bowl	146 276
Finger food	102 106 133 162 <> 167 172 176 185 195 202 206 212
Finger food insert	133 164
Finger food tongs	212
Fish dish	144 270
Fish serving fork	14 <> 72 106 119
Fish serving knife	14 <> 72 106 119
Flat serving tongs	212
Flatware	14 <> 72 86 88 96 98 102 104 106 118 119 163 206 209 210 243 282
Flower vase	283
Food pan	204 206
French fry holder	165 241 278
Front cooking & Apartments	318 <> 337
Fruit basket	151 155 158 159 189 202
Fruit bowl	135 146 149 150 151 152 153 155 234 237 262 265 308 309 342 346
Fruit salad bowl	146 216 237 340 342
Fruit stand	158 159 216 217 220 231 266
Fruit tongs	212 275
Frying pan	323 325 327 331 332 336
Frying pan for eggs	147 276

## GHIJKL

Giant champagne bucket	310
Glass	154 178 202 206 340 341 346
Glass coaster	257 264 267
Golf club mixer spoon	104 316
Grated cheese pot	133 219 239 259 260 262 263 265 269 276
Grater	282
Gravy boat	140 268
Grill	333
Gueridon	308
Happy spoon	106
Herbs mill	283
Holder	223 237 248 249
Honey spoon	98
Hors d'oeuvre tray	248 258
Hors d'oeuvre and pastry pliers	275 276
Ice and lemon tongs	212
Ice bucket	146 152 153 222 232 301 302 303 304 305 306 308 314 316 317 346
Ice bucket, insulated	232 304 305 306
Ice cream cup	147 180 182 225 237 238 280 288 341
Ice tea spoon	14 <> 72 77 106 295 312
Ice tongs	212 275 316
Intermezzo cup	100 278
Infuser jug	199
Infuser jug insert	199
Induction cooker	208
Jam and honey holder	225 269
Jar	176
Jug	147 291 292 293
Juice dispenser	209
Kitchen set	334
Knife rest	84 102 173 177 195 209
Knives	14 <> 72 86 88 104 118 160 243

Ladle	14 <> 72 106 210 301
LED Ice cubes	317
Lobster cracker	104
Lobster pick	94

## MNO

Meat dish	144 270
Micro fork	102 172 176
Micro and Mini presentoire	163 288
Milk boiler	337
Milk dispenser	209
Milk pot	220 291 292 294 295 296
Mini basket	177
Mini butter dish	144 225 239 277 288
Mini casserole	322 324 326
Mini fork	102 206
Mini spoon	102 206
Mini steamer	166
Mini table stand	281
Mini tray	164 181 182 183 202 220
Mixing glass	301
Monoportion fork	102 172 176 206
Monoportion spoon	102 172 176 177 206
Mug	343
Multifunctional spoon	96 163
Multipurpose bowl	218
Napkin holder	192 193 234 258 289 298
Napkin ring	130 259
Nut-cracker	282
Oil and vinegar set	262 277 280
Oil pourer	133 225 239 259 260 262 263 265 268 269

# Index

## M N O

Olive seeds jar	133 236
Oval meat dish	144 146 270 272
Oval dish/china	249 258
Oyster fork	14 <> 72
Oyster plate	158 159 161

## P Q R

Parmesan cheese basin	133 219 239 259 260 262 263 265 269 276
Parmesan spoon	14 <> 72
Party forks	102 172 176 206
Party spoon	14 <> 72
Pasta pot	337
Pasta pot insert	337
Pastry pliers	212 275
Pastry stand	173 177 216 217 220 221 227 266 288
Patè holder	144 225 239 288
Pepper grinder	283
Pepper shaker	154 225 239 268 269 274
Perfume drops dispenser	225
Petit four stand	173 177 216 217 220 221 231 266 287
Petit marmite	208
Pie pliers	212 275
Pinzimonio set	249
Plate cover, round	271 271 272 273
Plate, crescent	193 235
Plates	144 146 149 171 176 179 181 182 193 218 230 235 238 248 264 267 270 272 276 301 343
Pliers	104 147 212 275 276 293 316
Polycarbonate drinkware	338 <> 341
Porcelain insert	249 258
Presentoire	163 221 227 287 288 289
Punch bowl	223 227 301
Quarta Posata	90 <> 93 163 175
Relish dish	219 287 342 343
Riser	196 197
Room service system	251

## S

Salad bowl	146 216 237 309 342 346
Salt and pepper set	154 225 239 268 269 274
Salt cellar	219 269
Salt grinder	283
Salt shaker	154 225 239 268 269 274
Salt spoon	102 206
Salt/Pepper dispenser	154 225 239 268 269 274
Sauce boat	144 274
Sauce bowl	280
Sauce spoon	14 <> 72 106
Saucepan	322 324 326 331 334
Saucer	171 176 238 264 267 343
Sauteuse	246
Seafood stand	158 159 160 223 231
Serving fork	14 <> 72 104 106 119 209 210
Serving pliers	147 212 275
Serving spoon	14 <> 72 104 106 119 209 210
Serving tongs	147 212 275
Set for Risotti	258
Shaker	301
Show plate	134 146 149 151 165 186 194 257 263 264 266 283 346
Small spoon	102 206
Snack server	219 287 342 343
Soapstone	242
Soap tray	299
Soup cup	274
Soup tureen	208 224 274
Spaghetti tongs	147 212 275
Square tray	134 150 158 164 165 185 195 202 229 257 262
Stackable tray	228 229 235
Stackable tray for glasses	235
Stock pot	322 324 326 331 334
Street cover	139 141
Sugar bowl	147 154 220 291 292 294 295 296 298 299
Sugar, milk and coffee set	224 293
Sugar set	224 225 267 287 293
Sugar tongs	212 275 293
Sugar and cocktails tongs	212 293
Sugar/Tea bags holder	193 220 234 289 298 299
Supreme cup	219 238

## T U V W Y

Table grill	242 244
Table mat	134 138 140 185 194
Table number	185 223 237 278 281
Table number stand	185 223 237 278 281
Tacos holder	279
Tall container	125 126 128 146 153 186
Tea cup	343
Tea pot	220 291 292 294 295 296
Tea pot, insulated	296

## T U V W Y

Thermal serving unit	249 251
Tiffin' box	252
Toast rack	278 288
Toast/Pastry tongs	212 275
Tongs	104 147 212 275 276 293 316
Toothpick holder	185 195 219 225 234 239 268 269 274 280
Tray	123 133 134 144 150 158 159 161 164 165 175 177 179 180 181 182 185 186 189 192 194 195 202 206 209 215 218 228 229 230 234 235 236 254 257 260 262 263 264 272 273 279 280 288 289 298
Tray for rack trolley	186 235 254
Tray gn	185 186 194 215 228
Tray, oval	150 159 164 189 218 230 263 273
Tray, rectangular	123 133 134 144 150 158 164 185 186 189 192 194 195 202 206 209 215 218 228 229 230 234 235 236 254 257 260 262 263 264 272 273 279 280 288 289 298
Tray, round	159 161 175 177 215 218 229 230 236 257 260 264
Tray, square	134 150 158 164 165 185 195 202 229 257 262
Tray with holes	177
Trolley	348 <> 363
Truffle slicer	283
Tumbler	178
Underliner	238
Vacuum jug	291 292
Vase	171 176 346
Vegetable dish	224 274
Vegetable dish escoffier	274
Vegetable/Meat tongs	147 212 275
Vegetable pliers	147 212 275
Vegetable steamer	337
Vichyssoise cup	219 238 274
Vinegar dispenser	219 239 242 268
Water pitcher	199 291 292 294
Water pitcher, insulated	291 292
Wine cooler	304 305 307
Wine cooler stand	126 128 135 153 222 232 233 302 303 304 305 306 307 309 315
Wine holder	211 277
Wok	333 337
Yogurt cooler	210 223

# Index

## A B

Accessoires	82 <> 107
Ardoise	242
Assiette de bienvenue	134 146 149 151 165 186 194 257
	263 264 266 283 346
Batteries de cuisine	334
Beurrir	144 225 239 277 288
Bol	125 126 128 129 130 135 146 149
	150 151 152 153 155 172 174 176
	177 182 186 193 195 202 218 234
	235 237 259 262 263 265 280 342
	346
Bol à caviar	219 238
Bol à champagne	223 227 301
Bol à punch	223 227 301
Bol à rafraîchir	210 223
Bol à salade de fruits	146 216 237 249 342 346
Bol à sauce	280
Bol à snacks	219 287 342 343
Bol avec socle	146 147 216 218 223 237 301
Bol en bois	277
Bol en polycarbonate	135 309 310 340 342 343
Bol en polypropylène	346
Bol en verre	218 249
Bol universel	102 178
Boston shaker	301
Bouilleur	209
Bouilloire à lait	337
Borne étouffoir	154
Bouteille thermique	368 <> 371
Brasero avec pierres naturelles	242 244
But de canapé	308

## C

Cache eau mineral	279
Cafetière	220 291 292 294 295 296
Cafetière thermique	291 292 296
Carafe	199 291 292 294
Carafe à eau	199 291 292 294
Carafe à eau thermique	291 292
Cartouches eutectiques	358 359
Casse-noix	282
Cendrier	151 154 276
Cendrier à cigares	151 154 276
Centre de table/Comptoir	155 158 159 161 189 202
Chafing-dish	208 210
Chandelier	221 227
Chandelier/bougeoir	227
Chariot	348 <> 363
Chariot de service	229
Chopsticks	82
Cloche pour plat	221 223 224 236 251 273 276 281
Cloche pour plat ovale	272
Cloche pour plat rond	221 236 251 273 276
Cloche support à tartes	224 236 281
Coffee Urn	209
Conteneur à thé	220 291 292 294 295 296
Coquetier	147 276
Corbeille	125 126 128 129 130 135 146 149
	150 151 152 153 155 172 174 176
	177 182 186 193 195 202 218 234
	235 237 259 262 263 265 280 342
	346
Corbeille à pain	135 146 149 150 151 186 193 195
	218 234 235 237 259 262 265 280
	342
Corbeille pour aromatiques condiments	135 262 277 280
Corps de chauffe électrique	208
Coupe à beurre	144 225 239 264 267 277 288
Coupe à caviar	219 238
Coupe à creme/potage	274
Coupe à crevettes	219 238
Coupe à fruits	147 180 182 225 237 238 280 288
	341
Coupe à glace	147 180 182 225 237 238 280 288
	341
Coupe à intermezzo	100 278
Coupe à Martini	278 341
Coupe à punch	223 227 301
Coupe à suprême	219 238
Coupe à vichyssoise	219 238 274
Coupe multifonctions	218
Coupe sur pied	146 147 216 218 223 237 301
Coupe thermique à glaze	237 280 288
Coupelle	102 149 150 151 178 202 216 237
	276 277 342 343 346
Coupe-truffes	283
Couteau à huîtres	160
Couteau à servir poisson	14 <> 72 106 119
Couteaux	14 <> 72 86 88 104 118 160
	243
Couvercle	224 272 274
Couvercle légumier	224 274
Couverts	14 <> 72 86 88 96 98 102
	104 106 118 119 160 163 176 206
	209 210 243 274 282 299 301
Couvre-plat	270 273

## C

Crémier	154 248 288 299
Cuiller à bar	14 <> 72 104 106 299 316
Cuillère à miel	98
Cuiller à risotto	104 106 119 209 210
Cuiller à servir	14 <> 72 104 106 119 209 210
Cuiller à soda	14 <> 72 104 106 299 316
Cuillèr cocktail	14 <> 72 102 206
Cuillère à glace	14 <> 72 104 106 299 316
Cuillère à parmesan	14 <> 72
Cuillère à sauce	14 <> 72 119 210 274
Cuillère à sel	102 206
Cuillère monoportion	102 172
Cuillère multifonctionnelle	96 163
Cuit pâtes	337
Curette à homard	94 104

## DEF

Décapsuleur	282
Dessous de bouteille	185 186 195 257 264 267 283
Dessous de verre	257 264 267
Distributeur à jus	209
Distributeur à lait	209
Distributeur de serviettes	192 193 234 258 289 298
Doseur	301
Douser sel/poivre	154
Ecuelle	146 276
Élément pour cuit pâtes	337
Étagère	158 159 160 177 182 216 217 223
	227 231 266
Étiquettes	185 223 237 278 281
Faitout	322 324 326 331 334
Finger food	102 106 133 162 <> 167 172 176
	185 195 202 206 212
Fourchette amouse-bouche	102 172 176 206
Fourchette à escargots	104
Fourchette à fromage	104
Fourchette à huîtres	14 <> 72
Fourchette à servir	14 <> 72 104 106 119 209 210
Fourchette à servir poisson	14 <> 72 106 119
Fourchette cocktail	102 172 176 206
Fourchette monoportion	102 172 176 206
Fromagère	133 219 239 259 260 262 263 265
	269 276

## GHIL

Glacette thermique	304
Glaçon lumineux	317
Golfrosse pour cocktail	104 316
Gril	333
Huiliér	219 239 242 268
Huillier/vinaigrier	133 225 239 259 260 262 263 265
	268 269
Légumier	224 274
Légumier escoffier	274 0
Louche	14 <> 72 106 210 301

## MNO

Marmite traiteur	322 324 326 331 334
Ménagère	133 225 239 259 260 262 263 265
	268 269
Mesure à alcool, double	301
Micro fourchette	102 172 176
Mini corbeille	177
Mini faitoute	322 324 326
Mini marquer de table	281
Mini spoon	102 206
Mini plateau	164 181 182 183 202 220
Mini vaporisateur	166
Moulin à herbes	283
Moulin à piment	283
Moulin à poivre	283
Moulin à sel	283
Mug	343
Numéro de table	186 223 237 278 281
Ouvre-bouteilles	282

## PQ

Panier à fruits	135 146 149 150 151 152 153 155
	234 237 262 265 308 309 342 346
Passoire	337
Passoire à cocktail	282
Pelle à gâteau / à tarte	14 <> 72 106 118 209 210
Petit sous-plat	149 171 176 238 267 301 343
Petite marmite	208
Petite plateau	164 181 182 183 202 220
Pied pour bol a champagne	311
Pied pour seau à champagne	126 128 135 153 222 232 233 302
	303 304 305 306 307 309 315
Pince	104 147 212 275 276 293 316
Pince à amuse-bouche	212 293
Pince à asperges	147 212 275
Pince à escargots	104 275 276
Pince à fruits	212 275
Pince à glace	212 275 316
Pince à glaçon et citron	212
Pince à homard	104

# Index

## P Q

	Pag
Pince à hors-d'oeuvres et pâtisserie	212 275 293
Pince à légumes	147 212 275
Pince à pain et pâtisserie	212
Pince à pâtisserie	212
Pince à rôti	147 212 275
Pince à servir	212
Pince à spaghetti	147 212 275
Pince à sucre	212 275 293
Pince à sucre et apéritifs	212 293
Pince à tarte	212 275
Pince à toast et tarte	212 275
Pince fonde pour servir	212
Pince plaine pour servir	212
Plaque à induction	208
Plat à escargots	276
Plat à huîtres	158 159 161
Plat à oeuf	144 277
Plat à pain	149 267
Plat à poisson	144 270
Plat à présentation	134 146 149 151 165 186 194 257 263 264 266 283 346
Plat oval	144 146 270 272
Plat rond	144 151 206 251 270 272 340
Plateau	123 133 134 144 150 158 159 161 164 165 175 177 179 180 181 182 185 186 189 192 194 195 202 206 209 215 218 228 229 230 234 235 236 254 257 260 262 263 264 272 273 279 280 288 289 298
Plateau à hors d'oeuvre	248 258
Plateau à monnaie	176 301
Plateau avec trousse	177
Plateau carré	134 150 158 164 165 185 195 202 229 257 262
Plateau concave	279
Plateau en fibre de carbone	122 123
Plateau gn	185 186 194 215 228
Plateau ovale	150 159 164 189 218 230 263 273
Plateau porte verres empilable	235
Plateau pour chariot porte-plateau	186 235 254
Plateau rond	159 161 175 177 215 218 229 230 236 257 260 264
Plateau, rectangulaire	123 133 134 144 150 158 164 185 186 189 192 194 195 202 206 209 215 218 228 229 230 234 235 236 254 257 260 262 263 264 272 273 279 280 288 289 298
Poêle	323 325 327 331 332 336
Poivrier	154
Porcelaine	249 258
Porte brosse à dents	301
Porte confitures	225 269 299
Porte craquelins	178
Porte cure-dents	185 195 219 225 234 239 268 269 274 280
Porte gobelets	259
Porte gressin	151 178 186 193 195 279
Porte macarons	219 267 288
Porte noyaux	133 236
Porte petits fours	216 217 227 266 288
Porte pommes frites	165 242 278
Porte savon	299
Porte serviette	299
Porte-appetizers	219 287 342 343
Porte-badge	281
Porte-bouteille	277 279
Porte-pate/beurre/caviar	144 225 239 288
Porte-surprises	170 176
Porte toast	278 288
Pot à cuillères	301
Pot à lait	220 291 292 294 295 296 337
Pot à sucre	147 154 220 291 292 294 295 296 298 299
Presentoire	163 221 227 287 288 289
Quarta Posata	90 <> 93 163 175

## R S

Râpe	282
Rafrâchisseur à bouteille	304
Rafrâchissoir à yogourt	210 223
Ravier à parmesan	133 219 239 259 260 262 263 265 269 276
Rechaud à cafe	209
Rince doigts	146 276
Saladier	146 216 237 249 342 346
Salière	219 269
Saucière	144 274
Sauteuse	246
Seau à champagne	126 146 152 153 186 222 232 301 302 303 304 305 306 307 308 309 310 314 316 317 342 346
Seau à glace	146 152 153 222 232 301 302 303 304 305 306 308 314 316 317 346
Seau à glace, thermique	232 304 305 306
Seau à vin	126 146 152 153 186 222 232 301 302 303 304 305 306 307 308 309

## R S

	Pag
Seau à vin	310 314 316 317 342 346
Service à caviar	238
Set de table	134 138 140 185 194
Set pinzimonio	249
Set pour Amouse bouche	133
Set pour ceviche	281
Set salière, poivrier	154 219 225 239 268 269 274
Shaker	301
Soliflore	283
Soupière avec couvercle	208 224 274
Sous plat	134 146 149 151 165 186 194 257 263 264 266 283 346
Sous bouteille	185 186 195 257 264 267 283
Sous verre	257 264 267
Soutier de sacs	284
Soutier porte-couverts	84 102 173 177 195 209
Stands de buffet	196 197
Street Cover	138 140
Sucrier	147 154 220 291 292 294 295 296 298 299
Support	248 249
Support à tarte	173 177 216 230 266
Support avec numéro de table	185 223 237 278 281
Support pour seau à champagne / à vin	126 128 135 153 222 232 233 302 303 304 305 306 307 309 315
Support pour tacos	279
Support pour toast	278 288

## T V W

Tasse	343
Théière	220 291 292 294 295 296
Théière thermique	296
Tiffin box	252
Tire-bouchon	282
Tumbler	178
Vase	171 176 346
Vase à fleurs	283
Verre	154 178 202 206 340 341 346
Verseur de parfum en gouttes	225
Vinaigre	219 239 242 268
Vitrine réfrigérée	358 359
Wok	333 337

# Alphabetisches Register

## A B C

	Pag
Aderhalter	133 236
Ascher	151 154 276
Ascherständer	154
Auflaufform auf Porzellan	249 258
Austernöffner	160
Badge-Halter	281
Bargestell	219 287 342 343
Beilagenschale	146 276
Beutelstand	284
Bierbecher	341
Blumenvase	283
Bonbonsschale	170 176 265
Boston Shaker	301
Bowlenlöffel	301
Bratenplatte	144 270
Bratentopf	322 324 326 331 334
Bratpfanne	323 325 327 331 332 336
Brot Platte	149 267
Brotkorb	135 146 149 150 151 186 193 195 218 234 235 237 259 262 265 280 342
Brottschale	135 146 149 150 151 186 193 195 218 234 235 237 259 262 265 280 342
Buffet Display	202
Buffetständer	196 197
Buffet-Tablett	122 123 134 150 158 159 161 182 185 186 189 192 194 195 202 206 209 215 218 220 223 228 229 230 235 236 254 262 263 264 270 279 280 340
Butterdose	144 225 239 277 288
Butterkühler	264 267
Café au Lait-Set	224 293
Cappuccinolöffel	104 299
Cevichese	281
Chafing dish	208 210
Chafing dish besteck	209 210
Champagner Bowl	152 223 233 310 314 315
Champagner Bowlständer	311
Champagnerflaschenhalter	211
Champagnerglas	206 341
Chilimühle	283
Chillcup	219 238
Cocktailsieb	282
Coffee Urn	209
Cracker Schale	178

## DEF

Deckel	224 272 274
Dessertgestell	221 287
Dressingbehälter	144 274
Dressinglöffel	14 <> 72 119 210 274
Eierbecher-Set	144 277
Eierlöffel	14 <> 72
Eierpfanne	147 276
Einsatz Tablett	133 165
Eis- und Zitronenzange	212
Eisbecher	147 180 182 225 237 238 280 288 341
Eisfruchtbecher, Isoliert	237 280 288
Eisgefäß	146 152 153 222 232 301 302 303 304 305 306 308 314 316 317 346
Eisgefäß, Isoliert	232 304 305 306
Eislöffel	14 <> 72 104 106 299 316
Eisschale	238
Eisschaufel	14 <> 72
Eiswasserkrug	199 291 292 294
Eiswürfel LED	317
Eiszange	212 275 316
Essig-/Ölflasche	219 239 242 268
Essig-/Ölflaschenhalter	135 262 277 280
Essig-/Ölgestell	225 239 268 269
Essig-/Öl-Menage	133 225 239 259 260 262 263 265 268 269
Ess-Stäbchen Paar	82
Ess-Stäbchen Ablage	82
Etagère	158 159 160 177 216 217 223 227 231 266
Feuerschale	242 244
Fingerfoodzange	212
Fingerfood-/Vorspeisen-/Butter-Gefäß	102 133 151 164 165 178 202 206 218 219 236 238 242 264 267 277 278 342 343
Fingerschale	146 276
Fischplatte	144 270
Flachzange zum Servieren	212
Flasche, Isoliert	368 <> 371
Flaschenhalter	277 279
Flaschenteller	185 186 195 257 264 267 283
Fleischgabel	14 <> 72 104 106 119 209 210
Früchtekorb	135 146 149 150 151 152 153 155 234 237 262 265 308 309 342 346
Frühstück Tablett	133

## G H K

	Pag
Gebäckplatte	144 273
Gebäck- und Servierzange	212 276
Gemüseseiher	337
Gemüsetopf	337
Getränkekühler	154 209 210 233 291 292 304 315
Gewürzmenage	269
Gewürzständer	258
Glas	154 178 202 206 340 341 346
Glassflasche	219 239 242 268
Glaskrug	199
Glasschale	218 249
Glasuntersatz	257 264 267
Golf Schleger	104 316
Gratinplatte	144 272 273
Griffschale	129 130 149
Grifftablett	130 149
Grill Pfanne	333
Grissini-Halter	151 178 186 193 195 279
Gueridon	308
Happy Spoon	106
Heizelement	208
Honiglöffel	98
Hummergabel	94 104
Hummerzange	104
Innenteil für Spaghettitopf	337
Kaffeekanne	220 291 292 294 295 296
Kaffeekanne, isoliert	291 292 296
Kaffeespender	209
Kaffeetablett	298
Kartenhalter	223 237
Kartoffenbehälter	165 242 278
Kartoffellöffel	14 <> 72
Kasserolle	322 324 326 331 334
Kaviarkühler	219 238
Kaviarlöffel	282
Kaviarschale	219 238
Korkenheber	282
Korkenzieher	282
Kuchen-/Tortenplatte	218 230
Käsedose	133 219 239 259 260 262 263 265 269 276
Käsemesser	14 <> 72
Kohlefaser-Tablett	122 123
Kühlschale	158 159 160 161 210 223
Kühlvitrine	358 359

## LMN

Latte Macchiato-Set	299
Légumier	146 224 272 274
Leuchter	221 227
Löffelbecher	301
Macaronsträger	219 267 288
Marmeladegestell	225 269 299
Martini Glass	278 341
Milchdispenser	209
Milchkaffee-Set	224 293
Milchkanne	220 291 292 294 295 296
Milchkännchen	154 248 288 299
Milch-Kaffee-Zucker-Set	224 293
Milchkocher	337
Mikrogabel	102 172 176
Mini Bratentopf	322 324 326
Mini Butterdose	144 225 239 277 288
Mini Gabel	102 206
Mini Schale	177
Mini Spoon	102 206
Mini Tablett	164 181 182 183 202 220
Mini Verdampfer	166
Mokkaétagère	182 217 227 266
Mug	343
Multifunktionaler Löffel	96 163
Nussknacker	282

## OPQ

Obstschale	146 150 151 155 158 159 161 189 202 216 218 220 230 237 262 263 265 280 340 343 346
Papierbecherständer	259
Patisserie Tablett	192 234 235 289 298
Petits Fours-Ständer	173 177 216 217 220 221 227 266 288
Petits Fours-Tablett	179 180 181 182 183
Pfeffermühle	283
Pfefferstreuer	154
Platten	144 149 149 193 218 230 235 238 248 258 267 270 272 273 276 299
Platzteller	134 146 149 151 165 186 194 257 263 264 266 283 346
Portionsschöpfer	14 <> 72 106 210 301
Porzellanschale	249 258
Presentoire	163 221 227 287 288 289
Punchbowl	223 227 301
Quarta Posata	90 <> 93 163 175

## RS

Reibe	282
-------	-----

# Alphabetisches Register

RS	Pag
Reislöffel	104 106 119 209 210
Relish-Pickles-Gestell	219 287 342 343
Rotweinwiege	277
Saftdispenser	209
Saftkrug	199 291 292 294
Sahne-/Zucker-Set	224 293
Sahnegießer	154 248 288 299
Sahnekännchen	147 293
Salat-/Vorlegebesteck	14 <> 72 106 119 209 210
Salatzange	147 212 275
Salz- und Pfeffergestell	154 225 239 268 269 274
Salzmühle	283
Sauce Set	280
Saucenlöffel	14 <> 72 119 210 274
Sauciere	144 178
Sauteuse	246
Schale	125 126 128 129 130 135 146 149 150 151 152 153 155 172 174 176 177 182 186 193 195 202 218 234 235 237 259 262 263 265 280 342 346
Schalenhalter	248 249
Schmuckablage	170 176
Schnapsbecher	341
Schneckengabel	104
Schneckenzange	104 275 276
Schneckenplatte	276
Serviergestell	221 287
Serviertablett	123 133 134 144 150 158 159 161 164 165 175 177 179 180 181 182 185 186 189 192 194 195 202 206 209 215 218 228 229 230 234 235 236 254 257 260 262 263 264 272 273 279 280 288 289 298
Servierwagen	348 <> 363
Serviettenhalter	192 193 234 258 289 298
Serviettenring	130 259
Set mit Porzellanschale	258
Shot Glass	154
Snackschale	277
Sorbetschale	100 278
Spaghettitopf	337
Speckstein	242
Speisekartenhalter	223 237
Stand für Plastik Platte	259
Stapelbare Gläserträger Tablett	235
Steakmessern	14 <> 72 86 88 243
Stielkasserolle	322 324 326 331 334
Suppenmarmite	208
Suppenschöpfer	14 <> 72 106 301
Suppenstation	208
Suppentasse	274
Suppenterrine	224 274
Street Cover	138 140
Strohalm Halter	316

T	Pag
Tablett	123 133 134 144 150 158 159 161 164 165 175 177 179 180 181 182 185 186 189 192 194 195 202 206 209 215 218 228 229 230 234 235 236 254 257 260 262 263 264 272 273 279 280 288 289 298
Tablett Gastronorm	185 186 194 215 228
Tablett für Rack	186 235 254
Tablett für Stoffservietten	299
Tablett, konkave	279
Tablett, oval	150 159 164 189 218 230 263 273
Tablett, quadratisch	134 150 158 164 165 185 195 202 229 257 262
Tablett, rechteckig	123 133 134 144 150 158 164 185 186 189 192 194 195 202 206 209 215 218 228 229 230 234 235 236 254 257 260 262 263 264 272 273 279 280 288 289 298
Tablett, rund	159 161 175 177 215 218 229 230 236 257 260 264
Tacoshalter	279
Tafelaufsatz	155 158 159 161 189 202
Teeglas	202
Teekanne	220 291 292 294 295 296
Teekanne, Isoliert	296
Teller	146 251 272
Tellercloche	221 223 224 236 251 273 276 281
Thermische Ringröhre	249 251
Tiefzange zum Servieren	212
Tiffin box	252
Tischnummer	185 223 237 278 281
Tischnummernständer	185 223 237 278 281
Tischnummern-Aufsteller	223 237 281
Tischrestebehälter	151 176 301
Tischset	134 140 185 194
Toastständer	278 288
Tortenheber	14 <> 72 106 118 209 210
Tranchiergabel	14 <> 72 104 106 119 209 210
Tranchiermesser	14 <> 72 86 88 243

T	Pag
Tropf-Parfüm Aussteller	225
Trüffel Hobel	283
Tumbler	178
U V W	
Universalschale	146 216 237 342 343 346
Universalschale auf Holz	277
Universalträger	170 176
Vorspeisenplatte	248 258
Vorspeisen Set	133
Yogurtkühler	210 223
Warmhalteteller	251
Wasserascher	151
Weinbecher	206 340 341
Wein-/Sekt Kühler	126 146 152 153 186 222 232 301 302 303 304 305 306 307 308 309 310 314 316 317 342 346
Weinkühler	304 305
Weinkühlerständer	126 128 135 153 222 232 233 302 303 304 305 306 307 309 315
Whisky Becher	341
Wokpfanne	333 337
Z	
Zahlsteller	151
Zahnstocherbehälter	185 195 219 225 234 239 268 269 274 280
Zucker- und Cocktailszange	212 293
Zuckerdose	147 154 220 291 292 294 295 296 298 299
Zuckergestell	224 225 287 293
Zuckerständer	267
Zuckerstangengefäß	193 220 234 289 296 298 299
Zuckerzange	212 275 293

# Indice

A B	Pág.
Abrebotellas	282
Accesorios	82 <> 107
Aceitera	219 239 242 268
Apoyo para bolsas	284
Apoyo para chopsticks	82
Apoyo para cubiertos	84 102 173 177 195 209
Azucarera	193 220 234 289 296 298 299
Azucarero	147 154 220 291 292 294 295 296 298 299
Bac rond	258
Bajo plato	134 146 149 151 165 186 194 257 263 264 266 283 346
Bandeja	123 133 134 144 150 158 159 161 164 165 175 177 179 180 181 182 185 186 189 192 194 195 202 206 209 215 218 228 229 230 234 235 236 237 238 239 240 241 242 243 244 245 246 247 248 249 250 251 252 253 254 255 256 257 258 259 260 261 262 263 264 265 266 267 268 269 270 271 272 273 274 275 276 277 278 279 280 281 282 283 284 285 286 287 288 289 290 291 292 293 294 295 296 297 298 299
Bandeja con agujeros	177
Bandeja concavo	279
Bandeja cuadrada	134 150 158 164 165 185 195 202 229 257 262
Bandeja cuentas y propinas	176 301
Bandeja de fibra de carbono	122 123
Bandeja gn	185 186 194 215 228
Bandeja para estantes	186 235 254
Bandeja portaservilletas	299
Bandeja portavasos impilable	235
Bandeja rectangular	123 133 134 144 150 158 164 185 186 189 192 194 195 202 206 209 215 218 228 229 230 234 235 236 254 257 260 262 263 264 272 273 279 280 288 289 298
Bandeja redonda	159 161 175 177 215 218 229 230 236 257 260 264
Bandeja tartas	218 230
Baterias de cocina & accesorios	330
Bistequera	333
Bobina térmica	249 251
Bol à salade de fruits	146 216 237 309 342 346
Bol para caviar	219 238
Bol para limpiar dedos	146 276
Botella	242
Botella térmica	368 <> 371
<b>C</b>	
Cacerola	322 324 326 331 334
Cafetera	220 291 292 294 295 296
Cafetera térmica	291 292 296
Calentador de café	209
Calientador à inducción	208
Calientador eléctrico	208
Candelabro	221 227
Carros	348 <> 362
Cascanueces	282
Cazo	14 <> 72 106 301
Cenicero	151 154 276
Cenicero a columna	154
Centro mesa	155 158 159 161 189 202
Cesta	125 126 128 129 130 135 146 149 150 151 152 153 155 172 174 176 177 182 186 193 195 202 218 234 235 237 259 262 263 265 280 342 346
Cesta pan	135 146 149 150 151 186 193 195 218 234 235 237 259 262 265 280 342
Cesta para fruta	135 146 149 150 151 152 153 155 234 237 262 265 308 309 342 346
Cesto por aromaticos y condimentos	135 262 277 280
Cevichera	281
Chafing-dish	208 210
Chop sticks	82
Coctelera	301
Coctelera con vaso	301
Colador para cóctel	282
Colador para olla pastas	337
Columna porta cesta champany	311
Columna porta cubo champany	126 128 135 153 222 232 233 302 303 304 305 306 307 309 315
Contenedor para café	199 209
Contenedor para zumo de fruta	199 209
Contenedor sobres té	193 220 234 289 296 298 299
Copa caviar	219 238
Copa cóctel camarones	219 238
Copa con base	146 147 216 218 223 237 301
Copa de vidrio	218
Copa gazpacho/potage	274
Copa helado y macedonia	147 180 182 225 237 238 280 288 341
Copa mantequilla	219 238
Copa para intermezzo	100 278
Copa salsa	144 178 274
Copa soufflé	144 178 274
Copa térmica	237 280 288
Copa universal	102 178 0

C	Pág.
Copa vichyssoise	219 238 274
Copita	102 178 180 182 225
Cortador de trufas	283
Cuberteria	14 <> 72 86 88 96 98 102 104 106 118 119 160 163 176 206 209 210 243 274 282 299 301
Cubitera de champaña	152 223 233 310 314 315
Cubitera hielo	146 152 153 222 232 301 302 303 304 305 306 308 314 316 317 346
Cubitera hielo térmica	232 304 305 306
Cubito hielo LED	317
Cubo de champagne gigante	310
Cubo vino	126 146 152 153 186 222 232 301 302 303 304 305 306 307 308 309 310 314 316 317 342 346
Cubreplatos ovales	272 273
Cubreplatos, redondo	251 270 273
Cuchara arroz	104 106 119 209 210
Cuchara cocktail	14 <> 72 102 206
Cuchara de miel	98
Cuchara ensalada	14 <> 72 106 119 209 210
Cuchara multifuncional	96 163
Cuchara parmesán	14 <> 72
Cuchara servir	14 <> 72 104 106 119 209 210
Cucharita cappuccino	104 299
Cucharita caviar	282
Cucharita mezcladora	14 <> 72 104 106 299 316
Cucharita para sal	102 206
Cuchillo ostras	160
Cuchillo servir pescado	14 <> 72 102 115
Cuchillos	14 <> 72 86 88 104 118 160 243
Cúpula cobre-platos	221 223 224 236 251 273 276 281
Cuenco	146 149 150 151 177 178 182 202 216 218 225 235 237 259 277 309 340 342 343 346
Cuenco con bandeja	178 2 182 225
Cuenco con pedestal	146 216 237
Cúpula refrigerada	358 359
<b>D E F</b>	
Dispensador	209
Dosador sal/pimienta	154
Ensaladera	146 216 237 249 342 346
Entremesera	248 258
Escurridera	337
Finger Food	102 106 133 162 <> 167 172 176 185 195 202 206 212
Florero	283
Frutero	155 158 159 161 189
Fuente de marisco	144 161 270
Fuente oval	144 146 270 272
Fuente para Lasagne	249 258
Fuente pescado	144 270
<b>G H I J L</b>	
Golf club cucharita coctél	104 316
Gueridon	308
Hoguera con piedras naturales	242 244
Huevera	144 277
Individual en acero	185 194
Individual en madera	134
Individual en goma	138 <> 141
Inserto por finger food	133 165
Jarra	147
Jarra agua	199
Jarra leche	220 291 292 294 295 296
Jarra térmica	291 292
Jarrita lechera	154 248 288 299
Joyerero	170 176
Juego azucar	225 267 287 293
Juego café au lait	293 299
Juego leche, café y azucar	293 299
Lavadodos	146 276
Legumbreira	224 274
Legumbreira escoffier	274
<b>M N O</b>	
Mantèl individual	134 138 <> 140 185 194
Mantequillera	277 299
Marmeladero	225 269 299
Medida bar, doble	301
Micro tenedor	102 172 176
Mini bandeja	164 181 182 183 202 220
Mini cacerola	322 324 326
Mini cuenco	177
Mini spoon	102 206
Mini tenedor	102 206
Mini vaporizador	166
Molinillo chile	283
Molinillo hierbas	283
Molinillo pimienta	283
Molinillo sal	283
Mug	343
Número de mesa	185 223 237 278 281
Olla para pastas	337

# Indice

P Q	Pág.
Pala para tarta	14 <> 72 106 118 209 210
Pala pescado	14 <> 72 106 119
Palillero	185 195 219 225 234 239 268
	269 274 280
Panera	135 151 186 193 195 218 234 235
	259 265 280 342
Pedestal para tarta	173 177 216 217 220 221 227 266
	288
Petit marmite	208
Pimentero	154 225 239 268 269 274
Pinzas asados y verduras	147 212 275
Pinzas azucar	212 275 293
Pinzas azucar y aperitivos	212 293
Pinzas caracoles	104 275 276
Pinzas entremeses y pasteles	212 275
Pinzas espagueti	147 212 275
Pinzas espárragos	147 212 275
Pinzas frutas	212 275
Pinzas fundas para servir	212
Pinzas hielo	212 275 316
Pinzas hielo y limón	212
Pinzas llanas para servir	212
Pinzas pan y pasteles	212
Pinzas pasteles	212 275
Pinzas pasteles y tostadas	212 275
Pinzas por finger food	212
Pinzas servir	212
Pinzas verduras	147 212 275
Pinzimonio	249
Pizarra	242
Plancha refrigerada	358 359
Platillo para mantequilla	264 267
Platito bajo botellas	185 186 195 257 264 267 283
Platito bajo vasos	257 264 267
Plato caracoles	276
Plato concavo	193 235
Plato de presentación	134 146 149 151 165 186 194 257
	263 264 266 283 346
Plato huevos	147 276
Plato ostras	158 159 161
Plato para pan	149 267
Plato térmico	251
Ponchera	223 227 301
Porcelana	249 258
Porta bastoncillos de pan	151 178 186 193 195 279
Porta botellas	277 279
Porta cepillo de dientes	301
Porta cucharitas	301
Porta dulces	216 217 227 266 288
Porta galletas saladas	178
Porta granos	133 236
Porta jabón	299
Porta informaciones	223 237
Porta macaron	219 267 288
Porta numero de mesa	185 223 237 278 281
Porta paliillas	185 195 219 225 234 239 268
	269 274 280
Porta patatas fritas	165 242 278
Porta pescado	158 159 160 223 231
Porta servilletas	192 193 234 258 289 298
Porta sorpresas	170 176
Porta Tacos	279
Porta tarjeta	281
Porta tostadas	278 288
Porta vasos	259
Portapan	151 178 185 186 193 195 279
Portaplatos de plastica	259
Posabotella	185 186 195 257 264 267 283
Posavaso	257 264 267
Posavaso por mug	343
Pote leche	337
Presentoire	163 221 227 287 288 289
Puerto paté/mantequilla/caviar	225 269 299
Quarta Posata	90 <> 93 163 175
Quesera	133 219 239 259 260 262 263 265
	269 276

## R S

Rallador	282
Refrigerador para yogurt	210 223
Rompenueces	282
Salero y pimentero	154 225 239 268 269 274
Salsera	144 274
Saucière	144 178
Sauteuse	246
Servicio para aperitivos	133
Servicio para buffet	202 206
Servicio para café con leche	224 293
Servicio para caviar	238
Servicio para champagne	305
Servicio para ensaladas	249
Servicio para Lasagne	249 258
Servicio para salsa	280
Servicio por aromaticos y condimentos	135 262 277 280
Servicio por entremes	219
Servilletero	130 259

## R S

R S	Pág.
Sopera	208 224 274
Soportes de buffet	196 197
Soporte platos	221 287
Soporte multi usos	248 249
Street cover	138 140

## T V W

Tapa	224 272 274
Tapa legumbrera y sopera	224 274
Tarjetas	185 223 237 278 281
Tazas	343
Tenedor caracoles	104
Tenedor cocktail	102 172 176 206
Tenedor diápasón	104
Tenedor ensalada	14 <> 72 106 119 209 210
Tenedor langostas	94 104
Tenedor ostras	14 <> 72
Tenedor pescado	14 <> 72 106 119
Tenedor servir	14 <> 72 104 106 119 209 210
Tetera	220 291 292 294 295 296
Tetera térmica	296
Tiffin box	252
Tumbler	178
Vaso	154 178 202 206 340 341 346
Versador de perfume en gotas	225
Vinagrera	219 239 242 268
Vinagreras con saleros	133 225 239 259 260 262 263 265
	268 269
Wok	333 337

# Index

	Pag	Pag	Pag	Pag	Pag	Pag					
025	282	260	176	418	185	548	301	666C	153	729	301
03180	349	260	242	418	194	549	164	666C	309	730	152
03280	349	262G	159	419	186	549	202	666CMG	128	730	314
03680	349	262	159	419	194	550	343	666E	232	737	182
03780	349	264	280	420	185	551	301	666E	306	737	183
041104	353	270	192	420	194	552	343	666F	222	738	178
042104	353	270	234	421	102	553	340	666F	302	739	177
046104	353	272A	251	422	185	554	340	666H	303	740	102
047	282	272B	251	422	195	555N	206	666HMG	128	740	178
047104	353	272C	251	423	102	555	340	666I	233	742	179
048	282	273A	251	423	185	557	150	666I	315	742	181
049	282	273B	251	423	195	557	189	666K	311	742	182
051104	352	280	281	424	102	558	150	666L	307	743	176
052104	352	281	281	424	234	558G	159	666M	307	744	172
056104	352	289	165	425	252	558V	159	666MG	126	744	176
057104	352	289	242	426	185	559	151	666W	308	744	193
09150	349	289	242	427	186	561	150	666Z	308	745	179
09250	349	289	278	427	195	561	189	668MG	126	745	180
094	280	292	267	428	186	562	150	668	232	745	181
098	280	293	266	428	194	562G	158	668	306	745	182
09841	280	301	238	429	186	562V	158	669	232	746	181
099	346	301A	238	430	186	567	151	669	306	746	182
105	267	301C	238	430	307	568	151	669MG	126	746	183
106	267	301B	238	438	152	569	151	670	298	747	180
133	283	304	269	438	317	570	154	671	283	747	182
140	229	306	259	439	152	570	248	672	305	748	170
140K	229	307	259	439	317	571	154	674	233	748	176
141GN	228	308	259	446	278	574	248	674	315	749	172
144GN	228	309	268	447N	283	575	248	675	279	749	176
144GN2	228	310	259	451	278	576	249	675P	279	750	102
146GN	228	312	268	451	288	579	249	676	304	750	172
151	209	313	257	462N	283	580	249	678	305	750	176
152	279	315	257	464N	283	581	248	679	305	751	276
154	235	316	257	466N	283	582	248	680	305	752	276
155	133	317	259	473N	282	582	249	681	305	753	173
155	236	319	257	485	160	583	249	682	199	753	177
156	278	320	257	496AC	279	588P	206	683	316	754	175
163	133	321	259	497	268	588	340	684	316	754	177
168	260	323	257	498	239	590	343	685	233	755	284
169	260	324	268	499	299	591P	206	685	315	756	284
170	146	325	268	500	177	591	340	686	233	757	284
171	146	331	263	501	177	592	343	686	315	758	284
175	146	332	263	502	265	593	343	688	152	760	212
176	146	333	263	503	277	594	248	688	317	771	275
178	144	335	263	504	277	594	299	689	152	772	275
179	147	336	263	505	235	595	299	689	317	774	275
180	147	337	263	505	262	596	152	691	199	775	275
184	144	350	268	506	239	596	309	693	370	777	275
186	144	355	277	507	239	597	153	700	165	778	275
187	144	356	277	508	268	597	308	700	242	779	104
188	147	356	280	509	268	598	153	700	298	779	275
204	267	364A	296	510	268	598	308	702	239	779	276
205	192	364B	296	510	268	598	310	702	288	787	133
205	235	364T	296	510ST	268	599	135	703AC	171	789	134
205	289	370	303	511	274	599	152	703AC	176	789	134
206	192	371	303	511	274	599	309	703	299	791	134
206	235	380	316	512	269	599	309	704	193	791	134
206	289	381	316	512	269	599	342	704	234	791	165
206	298	382	196	513	239	601	269	704	289	791	165
208	267	382	275	513	239	602	269	704	298	791AC	133
209	264	382	316	514P	154	603	269	706	299	791AC	165
210	264	383	196	514S	154	604	269	707	277	791E	164
212A	189	384	197	516	193	605	342	708	301	793	133
212	189	385	197	516	234	606	343	709	281	794	133
220	227	386	197	516	289	607	153	711	277	795	134
222A	189	387	196	516	298	608	152	712	238	796	134
222	189	388	197	518	234	609	149	713	238	799N	277
225	358	389	197	520	164	611	269	714	238	799P	277
225	359	390	196	522	265	612	149	715	267	799W	277
229	280	391	196	523	177	616AC	149	716	264	804	135
230	280	403	185	525	239	617	149	717	178	844	265
232	279	403	194	526	288	620	242	718	178	870	151
235G	161	404	185	527	341	639	293	719	154	870	151
235	161	404	195	528	276	649	293	720	299	870	193
236	210	404	195	531	341	657	223	721	237	871	155
242	155	406	262	533	341	658	317	721	288	871	193
242G	160	407	262	534	341	660	305	722	238	872	178
24222G	160	408	262	535	341	661	301	723	238	874	146
252	158	409	262	536	341	662	304	725	238	878	147
252G	158	410	262	543N	206	663	304	727	100	879	147
254	237	411	262	543	341	664	304	727B	100	880	146
258	227	415	236	544	277	665	301	727N	100	881	147
258	288	416	185	545	301	666	304	727O	100	882	146
260	165	416	195	546	301	666A	305	727OI	100	883	337
260	171	417	186	547	301	666B	135	727	278	884	146

# Index

	Pag	Pag	Pag	Pag	Pag	Pag					
886	346	982	218	7071	227	17440	144	24730	273	28450	236
888	346	982	220	7072	227	17726	144	24731	221	28460	236
891	346	983	223	7073	227	17731	144	24731	273	28730	230
892	346	984	221	7086	210	18130	144	24732	221	28740	230
899	153	984	287	7087	210	18140	144	24732	273	28750	230
899	314	985	221	7090	210	18235	144	24733	221	28760	230
901	278	985	287	7092	221	18240	144	24733	273	28830	230
902	165	986	223	7093	221	18514	146	25035	229	28840	230
902	242	987	223	7094	221	18520	146	25040	229	28850	230
902	298	988	225	7199	208	18524	146	25127	270	28860	230
903	278	989	221	7199A	208	19931	264	25130	270	29419	266
904	276	989	287	7199B	208	20130	264	25135	270	29424	266
905	279	990	180	7199C	208	20140	264	25140	270	29535	230
905P	279	990	182	7201	208	20150	264	25327	273	29645	230
906	82	990	225	7201A	208	20240	264	25335	223	29745	230
906	84	994A	237	7201B	208	20250	264	25335	273	29840	230
907	237	994B	237	7201C	208	20325	264	25340	273	30280	360
909	153	994C	281	7206	209	20331	264	25506	163	30538	257
909	314	995A	223	7208	209	20560	192	25506	288	30545	257
910	153	995B	223	10192	354	20560	235	25508	163	30980	360
910	314	996	278	10292	354	20560	289	25508	288	31440	279
911	276	998	277	10333	266	20660	192	25514	227	31455	279
912	153	999C	154	10335	266	20660	235	25514	289	31802	268
912	314	1001	130	10432	283	20660	289	25520	227	32250	362
913	281	1003	130	10692	354	20660	298	25520	289	32950	362
914	182	1004	130	10792	354	20724	234	25524	227	33298	361
914	183	1005	130	12150	350	20730	234	25524	289	33998	361
914	220	1006	130	12250	350	20734	234	25627	229	36101	296
915	84	1009	129	12650	350	21126	273	25635	229	36104	296
916	178	1010	129	12750	350	21131	273	25640	229	36106	296
918	178	1011	128	13132	266	22512	236	25714	227	36108	296
919	174	1012	128	13626	298	22512	281	25714	288	36110	296
919	177	1013	128	13760	229	22522	236	25720	227	36116	296
920	102	1014	128	13860	229	22522	281	25720	288	36202	296
920	173	1016	125	13960	229	22528	236	25728	227	36204	296
920	177	1017	125	14130	228	22528	281	25728	288	36206	296
922	225	1581	337	14135	228	23125	270	25920	237	36208	296
935	219	1591	337	14140	228	23130	270	25928	237	36301	296
935	288	2180	333	14145	228	23135	270	26202	155	36304	296
937	218	3100J	141	14150	228	23140	270	26202G	160	36306	296
938	218	3100S7	141	14160	228	23145	270	26203	155	36308	296
939	224	3101H7	141	14180	228	23150	270	26203G	160	36316	296
939	293	3101Q7	141	14190	359	23160	270	26204	155	36606	296
940	224	3102F7	141	14270	123	23330	270	26204G	160	36608	296
940	293	3102N7	141	14290	359	23335	270	26303	272	36704	296
940E	224	3200J	141	14440	228	23340	270	26403	272	36706	296
940E	293	3200S7	141	14445	228	23345	270	26524	192	42945	254
941	301	3201H7	141	14450	228	23350	270	26524	234	42963	254
941	316	3201Q7	141	14460	228	23535	272	26524	289	51610	234
942	225	3202F7	141	14480	228	23540	272	26530	192	51610	289
943	225	3202N7	141	14630	228	23635	272	26530	234	51710	346
943	225	3300J	141	14635	228	23640	272	26530	289	51722	346
947	225	3300S7	141	14640	228	23825	273	26534	192	51728	346
948	307	3301H7	141	14645	228	23830	273	26534	234	51755	346
949	223	3301Q7	141	14650	228	23835	273	26534	289	52405	288
956	276	3302F7	141	14660	228	23840	273	26602	272	52603	164
957	220	3302N7	141	14680	228	23845	273	26702	272	52604	164
958	218	3403F7	139	15014	193	24155	270	26820	273	52922	164
959	218	3403N7	139	15014	235	24170	270	26824	273	53012	166
960	218	3404J	139	15018	193	24202	155	26826	273	53022	166
963GN	215	3404S7	139	15018	235	24202G	160	26827	273	53706	160
968	219	3405H7	139	15020	193	24355	270	26828	273	53706	202
969	219	3405Q7	139	15020	235	24370	270	26830	273	53712	164
970	219	3503F7	139	15022	193	24530	273	26831	273	53712	202
971	219	3503N7	139	15022	235	24535	273	26833	273	55737	150
972	222	3504J	139	15024	193	24540	273	26928	270	55737	189
972P	222	3504S7	139	15024	235	24545	273	27228	251	55837	150
972	302	3505H7	139	15026	193	24550	273	27230	251	56012	151
972P	302	3505Q7	139	15026	235	24710	221	27233	251	56012	202
973	222	3600J	141	15028	193	24710	273	27328	251	56015	151
973P	222	3600S7	141	15028	235	24713	221	27330	251	56015	202
973	302	3601H7	141	15338	235	24713	273	27333	251	56022	151
973P	302	3601Q7	141	15338	254	24714	221	28215	242	56022G	159
974	221	3602F7	141	16190	358	24714	273	28215	244	56022V	159
975	219	3602N7	141	16290	358	24720	221	28222	242	56022	202
976	219	7001B	231	16440	260	24720	273	28222	244	56032	151
976C	219	7002B	231	16450	260	24722	221	28232	242	56032	202
976S	219	7003A	266	16535	260	24722	273	28232	244	56123	150
976C	287	7003B	266	17230	144	24724	221	28327	236	56123	189
976S	287	7004A	231	17240	144	24724	273	28335	236	56315	150
978	217	7004B	231	17250	144	24726	221	28340	236	56315	202
980B	217	7011	202	17355	144	24726	273	28430	236	56322	150
980A	217	7011E	202	17370	144	24728	221	28435	236	56322	202
981A	216	7012	206	17427	144	24728	273	28440	236	56415	150
981B	216	7070	227	17435	144	24730	221	28445	236	56422	150

# Index

Pag		Pag		Pag		Pag		Pag		Pag	
56422G	158	64302	292	78850	134	96635	215	280122	324	10001175	84
56422V	158	64304	292	79230	134	96640	215	280124	324	10001175B	84
57220	242	64306	292	79250	134	96727	215	281109	324	10001175N	84
57234	242	64308	292	79715	135	96735	215	281114	324	10001175O	84
57262	242	64310	292	79720	135	96740	215	281116	324	10001175OI	84
58912	342	64312	292	83422	237	97413	287	282112	324	10001175	209
58922	342	64316	292	83434	237	97419	287	282120	324	10061101	118
58928	135	64402	292	84331	265	97713	216	282122	324	10061102	118
58928	309	64402P	292	86320	237	97719	216	282124	324	10061103	118
58928	342	64404	292	86420	237	97803	217	282128	324	10061104	118
58970	310	64404P	292	87504	147	98402	221	283124	324	10061105	118
59870	310	64406	292	87508	147	98402	287	283128	324	10061106	118
61322	149	64406P	292	92727	218	100222	130	284122	325	10061107	118
61340	149	64408	292	92735	218	100240	130	284126	325	10061110	119
61422	149	64408P	292	92740	218	120120	331	284130	325	10061111	119
61440	149	64504	292	92830	218	120124	331	290576	249	10061115	118
61739	149	64506	292	92835	218	121116	331	430350	239	10061116	118
62101	291	64512	292	92840	218	122120	331	430491	269	10061120	119
62102	291	64604	291	92845	218	122124	331	430491SS	269	10061121	119
62104	291	64606	291	92850	218	123128	331	430510SS	239	10061122	119
62106	291	64612	291	92860	218	124126	331	430510SS	239	10061123	119
62108	291	65102	295	93612	224	150008	334	430510ST	268	10061140	119
62110	291	65104	295	93622	224	150014	334	430511SS	274	10061142	119
62112	291	65106	295	93628	224	150120	334	430602	269	10101136	88
62116	291	65108	295	94003	225	150122	334	647150	292	10101136	243
62202	291	65110	295	94003	287	150124	334	648150	291	10131140	274
62204	291	65112	295	94003	293	151116	334	720411	209	10141136	88
62206	291	65116	295	94004	225	152120	334	720419	209	10141136	243
62208	291	65202	295	94004	287	152122	334	799906	211	10201110	210
62210	291	65204	295	94004	293	152124	334	799909	211	10201111	210
62301	291	65206	295	94005	224	153126	334	10001108	282	10201116	210
62302	291	65208	295	94005	293	153130	334	10001109	106	10201122	210
62304	291	65301	295	94414	224	157122	337	10001110	106	10201123	210
62306	291	65302	295	94418	224	157222	337	10001110	209	10201136	88
62308	291	65304	295	94420	224	157830	337	10001111	106	10201136	243
62310	291	65306	295	94422	224	157922	336	10001111	209	10201140	210
62312	291	65308	295	94424	224	157926	336	10001115	106	10201141	210
62316	291	65310	295	94426	224	157930	336	10001116	106	10201142	210
62402	291	65312	295	94428	224	180120	322	10001116	209	10201143	104
62402P	291	65316	295	94514	224	180120O	326	10001120	106	10201143	210
62404	291	65402	295	94518	224	180122	322	10001121	106	10201144	104
62404P	291	65404	295	94520	224	180122O	326	10001122	106	10201144	299
62406	291	65406	295	94522	224	180124	322	10001122	209	10231136	88
62406P	291	65408	295	94524	224	180124O	326	10001123	106	10231136	243
62408	291	67301	232	94526	224	181109	322	10001123	209	10341136	88
62408P	291	67301	306	94528	224	181109O	326	10001124	106	10341136	243
63102	294	67304	232	94614	224	181114	322	10001125	104	10341146	96
63104	294	67304	306	94618	224	181114O	326	10001126	104	10341146B	96
63106	294	67701	304	94620	224	181116	322	10001127	106	10341146N	96
63108	294	67704	304	94622	224	181116O	326	10001128	82	10341146O	96
63110	294	68702	199	94624	224	182112	322	10001128B	82	10341146OI	96
63112	294	69202	199	94626	224	182112O	326	10001128N	82	10341146	163
63116	294	70110	274	94628	224	182118	322	10001128O	82	10521108	102
63202	294	70115	274	95014	216	182118O	326	10001128OI	82	10521108	206
63204	294	70130	274	95020	216	182120	322	10001129	92	10521131	102
63206	294	72611	278	95024	216	182120O	326	10001129	163	10521131	206
63208	294	72620	278	95028	216	182122	322	10001129	175	10701136	88
63301	294	73112	274	95104	220	182122O	326	10001133	98	10711136	88
63302	294	73214	274	95106	220	182124	322	10001133B	98	TU0687G	199
63304	294	73218	274	95202	220	182124O	326	10001133N	98	TU0692V	199
63306	294	73220	274	95206	220	183124	322	10001133O	98		
63308	294	73222	274	95302	220	183124O	326	10001133OI	98		
63310	294	73224	274	95304	220	183128	322	10001136	88		
63312	294	73226	274	95406	220	183128O	326	10001136	243		
63316	294	73228	274	95613	276	184122	323	10001138	104		
63404	294	73614	274	96330	215	184122O	327	10001139	94		
63406	294	73618	274	96335	215	184126	323	10001139B	94		
63408	294	73620	274	96340	215	184126O	327	10001139N	94		
63510	294	73622	274	96345	215	184130	323	10001139O	94		
63516	294	73624	274	96350	215	184130O	327	10001139OI	94		
64101	292	73626	274	96360	215	213132	333	10001139	104		
64102	292	73628	274	96440	215	217828	333	10001140	104		
64104	292	74116	276	96445	215	217920	332	10001141	106		
64106	292	78125	246	96450	215	217924	332	10001142	106		
64108	292	78130	246	96460	215	217928	332	10001142	209		
64110	292	78135	246	96530	215	217932	332	10001144	86		
64112	292	78140	246	96535	215	247075	221	10001144B	86		
64116	292	78214	274	96540	215	247075	273	10001144N	86		
64202	292	78218	274	96545	215	247100	221	10001144O	86		
64204	292	78220	274	96550	215	247100	273	10001144OI	86		
64206	292	78222	274	96560	215	247132	221	10001144	243		
64208	292	78224	274	96613	215	247132	273	10001147	104		
64210	292	78226	274	96619	215	247145	221	10001150	104		
64300	292	78228	274	96624	215	247145	273	10001150	316		
64301	292	78830	134	96627	215	280120	324	10001151	301		



*Ci mettiamo il cuore*



HOTEL Catalog



[www.mepra.it](http://www.mepra.it)



HOTEL Catalog USA



HOTEL Catalog



25065 LUMEZZANE - BRESCIA - ITALIA - VIA MONTINI 176  
TEL. 0308921441 - FAX 0308925075 - [MEPRA@MEPRA.IT](mailto:MEPRA@MEPRA.IT)  
[WWW.MEPRA.COM](http://WWW.MEPRA.COM)