

# GUY DEGRENNE

Catalogue - Catalog  
2026



## **GUY DEGRENNE, L'ÉLÉGANCE FRANÇAISE RÉINVENTÉE**

En 1948, Guy Degrenne rêvait d'offrir le beau à tous, en créant des pièces qui résistent au temps et subliment chaque repas. Plus de 75 ans plus tard, cet esprit visionnaire demeure. Aujourd'hui, la Maison Guy Degrenne ouvre un nouveau chapitre, portée par la famille Spruch. Les quatre frères : Antoine, Marc-Alain, Benjamin et Thomas, s'engagent chaque jour pour faire rayonner cette Maison française et perpétuer son héritage.

Nous retrouvons notre nom historique, symbole d'élégance et d'excellence. Une identité graphique repensée, épurée et contemporaine, qui puise dans nos racines pour mieux exprimer notre ambition : magnifier l'art de recevoir, partout dans le monde.

Dans nos trois Manufactures, à Vire en Normandie, à Limoges et en Hongrie, se perpétuent des gestes rares. L'inox, le métal argenté, la porcelaine fine : chaque matière raconte une histoire, celle d'un savoir-faire transmis et réinventé. Ici, l'artisanat rencontre la précision industrielle pour créer des collections raffinées, pensées pour les Chefs, la gastronomie et les plus belles tables.

De Paris à New York, de Séoul à Dubaï, Guy Degrenne incarne l'art de vivre à la française : la convivialité, le goût du détail, la beauté intemporelle. Nos créations accompagnent les hôtels haut de gamme, les restaurants d'exception et les tables privées où chaque repas devient une expérience.

Guy Degrenne, la signature française du savoir-faire et du style au service de la gastronomie

## **GUY DEGRENNE, FRENCH ELEGANCE REINVENTED**

*In 1948, Guy Degrenne dreamed of bringing beauty to every table, creating pieces that stand the test of time and elevate every dining experience. More than 75 years later, that visionary spirit lives on. Today, the Guy Degrenne House opens a new chapter, driven by the Spruch family. The four brothers : Antoine, Marc-Alain, Benjamin and Thomas, are committed every day to preserving this heritage and projecting it into the future.*

*We proudly return to our historic name – a symbol of French elegance and excellence. A redesigned visual identity, sleek and contemporary, rooted in tradition yet expressing our ambition: to celebrate the art of hospitality worldwide.*

*In our workshops in Normandy, Limoges and Hungary, rare gestures endure. Stainless steel, silver-plated metal, fine porcelain – each material tells a story of craftsmanship passed down and reinvented. Here, artisanal expertise meets industrial precision to create refined collections designed for chefs, gastronomy and the most beautiful tables.*

*From Paris to New York, Seoul to Dubai, Guy Degrenne embodies the French art de vivre: conviviality, attention to detail, timeless beauty. Our creations accompany premium hotels, exceptional restaurants and private tables where every meal becomes an experience.*

*Guy Degrenne, the French signature of craftsmanship and style in the service of gastronomy*

PARTENAIRES D'EXCELLENCE

PARTNERS OF EXCELLENCE



**ILS NOUS FONT CONFIANCE  
THEY TRUST US**

**ACCOR HOTELS**  
FAIRMONT  
PULLMAN  
RAFFLES  
SOFITEL /BARRIÈRE

**AMAN RESORTS**

**AUBERGE RESORTS**

**FOUR SEASONS**

**HILTON WORLDWIDE**

**HYATT**  
PARK HYATT  
ALILA

**INTERCONTINENTAL**

**LOUVRE HOTELS**  
GOLDENTULIP

**LUTETIA**

**MANDARIN ORIENTAL**

**MARRIOTT**  
RITZ CARLTON  
ST REGIS HOTELS & RESORTS  
W HOTELS

**MGM RESORTS**  
BELLAGIO  
MGM GRAND  
ARIA

**MONTAGE HÔTELS & RESORTS**

**ONE AND ONLY RESORTS**

**PENINSULA**

**SOCIETE DES BAINS DE MER**

**WALDORF ASTORIA**

## LES COUVERTS CUTLERY

### LES COUVERTS CLASSIQUES CLASSICAL FLATWARE

	ABSOLU	11
<b>NEW</b>	ACROPOLE	13
	BLOIS	15
	CONFIDENCE	19
	CONTOUR	21
<b>NEW</b>	EMPIRE	23
	FLORENCIA	25
<b>NEW</b>	LE V	27
	LUTÈCE	29
	MARQUISE	31
	MIKADO	33
	MIKADO VINTAGE	35
	MILADY	37
	NEUILLY	39
	NORMANDY	41
	SWELL	43
	VERLAINE	45
	VIEUX PARIS SATINÉ	49

### LES COUVERTS DESIGN DESIGN FLATWARE

	AQUATIC	53
	ASTRÉE CISELÉ	55
	COUTURE	57
	FUSE	59
	FUSE MARTELÉ	61
	FUSE MARTELÉ LAITON	63
	GUEST	65
	GUEST CUIVRE	67
	GUEST STAR	69
	GUEST VINTAGE	71
	L'É STARCK	73
	NORWAY	75
	ONDE	77
	ONDE GOLD	79
	OVATION	81
	RIVAGE	83
	SOLSTICE	85
	SUPERNATURE	87
	XY	89
	XY BLACK	91

## LES PIÈCES COMPLÉMENTAIRES ADDITIONAL PIECES

	COUTEAUX À STEAK	95
	Le Phil	
	Le Phil Vintage	
	Mirage Les Essences	
	Mirage Anthracite	
	Mirage Blanc	
	COUTEAUX À STEAK	
	MANCHE ORFÈVRE	96
	COUTEAUX À STEAK MONOBLOC	97
	ACCESSOIRES PLATERIE	99
	CUILLÈRES À SODA	99
	FOURCHETTES À HUÎTRE	99
	FOURCHETTES À ESCARGOT	99
	MODULO	99
	BLOIS	100
	VERLAINE	100
	PETIT GOURMET	101
	TYPE DROIT	101
	TYPE GOUTTE	101
	XY	101

## LA VAISSELLE DINNERWARE

### LA PORCELAIN DE LIMOGES LIMOGES PORCELAIN

	COLLECTION L	107
	COLLECTION L COUTURE	111
	COLLECTION L FRAGMENT	113
	COLLECTION L FRAGMENT NOIR	115
	COLLECTION L PERLES DE ROSÉE	117
<b>NEW</b>	COLLECTION L RAYON	119
<b>NEW</b>	COLLECTION L RAYON NOIR	121
	ÉCLIPSE	123
	GALON OR	125
	GALON PLATINE	129
<b>NEW</b>	RÉMINISCENCE	133
	RÉMINISCENCE COULEUR	135
	SD ONE	137
	SUPERNATURE	139



## LA CÉRAMIQUE CERAMIC

BAHIA & COCOTTES ONYX . . . . .	143
BAHIA PIERRE DE LUNE . . . . .	144
COCOTTES BLANC SABLE . . . . .	145
COCOTTES BLANC . . . . .	145
BAHIA & COCOTTES DUNE . . . . .	146
BAHIA & COCOTTES BLEU DE ROCHE . . . . .	147
BAHIA & COCOTTES ARGILE VERTE . . . . .	148
COCOTTES BLEU GOURMET . . . . .	149
COCOTTES ROSE NUDE . . . . .	149
BLUE SHADES . . . . .	151
BORÉAL . . . . .	153
BORÉAL ONDE . . . . .	155
BORÉAL SATIN . . . . .	157
BRUME . . . . .	159
COURONNE DORÉE . . . . .	161
COURONNE ARGENTÉE . . . . .	163
<b>NEW</b> ÉCLATS . . . . .	165
GRAPHIQUE . . . . .	167
GRAPHIQUE DORÉ . . . . .	169
LA VAISSELLE DE L'ÉCONOME . . . . .	171
MODULO . . . . .	173
MODULO NATURE PIERRE DE LAVE . . . . .	177
MODULO NATURE KAOLIN . . . . .	178
MODULO NATURE TERRE D'OMBRE . . . . .	179
MODULO NATURE BLEU GALET . . . . .	180
MODULO NATURE JADE . . . . .	181
RIVAGE . . . . .	183

## LE THÉ ET LE CAFÉ TEA & COFFEE

SALAM . . . . .	189, 191, 193, 195 ET 197
SALAM ACCESSOIRES . . . . .	199
EMPILEO . . . . .	201
SALAM THÉ . . . . .	203
MODULO . . . . .	203
COLLECTION L . . . . .	205
COLLECTION L COUTURE . . . . .	205
COLLECTION L FRAGMENT . . . . .	205
COLLECTION L PERLES DE ROSÉE . . . . .	205
COLLECTION L RAYON . . . . .	205
SD ONE . . . . .	205
GALON OR . . . . .	207
GALON PLATINE . . . . .	207
BORÉAL . . . . .	209
BORÉAL SATIN . . . . .	209
COURONNE DORÉE . . . . .	211
COURONNE ARGENTÉE . . . . .	211
GRAPHIQUE . . . . .	213
GRAPHIQUE DORÉ . . . . .	213
NEWPORT . . . . .	215
MODULO NATURE . . . . .	217

## LES VERRES GLASSWARE

### LES VERRES À PIED STEMMED GLASSES

ALLURE . . . . .	223
ANYTIME . . . . .	225
ORIGINE . . . . .	225
DOMAINE . . . . .	227
GALATÉE . . . . .	229
MONTMARTRE . . . . .	231
HYPNOTIC . . . . .	231
MUSE . . . . .	233

### LES GOBELETS ET LES CARAFES TUMBLERS & CARAFES

ALLEGRO . . . . .	237
COSMOPOLITAIN . . . . .	239
DOLCE . . . . .	239
EMPILEO . . . . .	241
INSTANT . . . . .	243
LOOP . . . . .	243
ROC . . . . .	243
MAMBO . . . . .	245
CARAFES ET DECANTEURS . . . . .	247

## LA PLATERIE HOLLOWARE

NEWPORT PLATEAUX . . . . .	253
NEWPORT CUBIQUE PLATEAUX . . . . .	255
NEWPORT TABLE . . . . .	257
NEWPORT CAFÉTERIE . . . . .	259
NEWPORT BAR . . . . .	261
NEWPORT ACCESSOIRES . . . . .	263

## LE BUFFET EVENTO EVENTO BUFFET

CHAFING DISHES . . . . .	271
MODULES FROIDS . . . . .	273
URNE À JUS DE FRUITS . . . . .	276
DISTRIBUTEURS À CÉRÉALES . . . . .	277
SUPPORTS DE PRÉSENTATION . . . . .	280
PLANCHES LES ESSENCES . . . . .	283
ACCESSOIRES . . . . .	284
PIÈCES DÉTACHÉES . . . . .	286





## LES COUVERTS

Dans notre Manufacture de Vire en Normandie, les majestueuses bobines d'inox prennent vie sous les gestes experts de nos artisans. Chaque couvert Guy Degrenne, qu'il soit classique ou design comme nos iconiques Blois, Verlaine, Normandy ou XY, est pensé pour conjuguer ergonomie, résistance et beauté intemporelle. Faciles à entretenir, nos pièces répondent aux exigences des tables les plus prestigieuses. Finitions soignées, lignes élégantes ou audacieuses : nos collections, créées avec des Chefs ou inspirées par nos designers, sont de véritables œuvres d'orfèvrerie. Pour sublimer vos expériences gastronomiques, nos couverts peuvent être proposés en finition métal argenté, une finition réalisée dans notre Manufacture.

## CUTLERY

*In our Manufacture in Vire, Normandy, majestic stainless-steel coils come to life under the expert hands of our artisans. Every Guy Degrenne piece, whether classic or contemporary like our iconic Blois, Verlaine, Normandy or XY, is designed to combine ergonomics, durability, and timeless beauty. Easy to maintain, our cutlery meets the highest standards of the most prestigious tables. Meticulous finishes, elegant or bold lines: our collections, created in collaboration with Chefs or inspired by our designers, are true masterpieces of silversmithing. To elevate your gastronomic experiences, our cutlery can also be offered in a silver-plated finish, crafted in our own Manufacture.*

*gd.*



Découvrez les coulisses de notre manufacture à Vire

*Discover our Manufacture in Vire*



LES COUVERTS CLASSIQUES  
CLASSICAL FLATWARE

	ABSOLU . . . . .	11
<b>NEW</b>	ACROPOLE . . . . .	13
	BLOIS . . . . .	15
	CONFIDENCE . . . . .	19
	CONTOUR . . . . .	21
<b>NEW</b>	EMPIRE . . . . .	23
	FLORENCIA . . . . .	25
<b>NEW</b>	LE V . . . . .	27
	LUTÈCE . . . . .	29
	MARQUISE . . . . .	31
	MIKADO . . . . .	33
	MIKADO VINTAGE . . . . .	35
	MILADY . . . . .	37
	NEUILLY . . . . .	39
	NORMANDY . . . . .	41
	SWELL . . . . .	43
	VERLAINE . . . . .	45
	VIEUX PARIS SATINÉ . . . . .	49



# ABSOLU



**126556**  
FOURCHETTE DE TABLE  
TABLE FORK  
L 202 mm L 7 in<sup>15/16</sup>



**126578**  
FOURCHETTE À POISSON  
FISH FORK, 3 TINE  
L 181 mm L 7 in<sup>1/8</sup>



**126565**  
COUTEAU DE TABLE MANCHE  
ORFÈVRE LAME UNIE  
TABLE KNIFE, HOLLOW HANDLE  
L 231 mm L 9 in<sup>1/8</sup>



**126581**  
COUTEAU À POISSON  
FISH KNIFE  
L 201 mm L 7 in<sup>15/16</sup>



**130332**  
COUTEAU DE TABLE MANCHE  
ORFÈVRE LAME SCIE  
TABLE KNIFE, HOLLOW HANDLE,  
SERRATED  
L 231 mm L 9 in<sup>1/8</sup>



**126559**  
CUILLÈRE À CAFÉ  
COFFEE / TEASPOON  
L 139 mm L 5 in<sup>1/2</sup>



**126553**  
CUILLÈRE DE TABLE  
TABLE / PASTA SPOON  
L 207 mm L 8 in<sup>1/8</sup>



**155452**  
CUILLÈRE À MOKA  
DEMITASSE / ESPRESSO  
SPOON  
L 111 mm L 4 in<sup>3/8</sup>



**155528**  
CUILLÈRE À SOUPE ANGLAISE  
BOUILLON SPOON, ROUND  
L 175 mm L 6 in<sup>7/8</sup>



**126591**  
FOURCHETTE DE SERVICE  
SERVING FORK  
L 250 mm L 9 in<sup>13/16</sup>



**126569**  
CUILLÈRE À DESSERT  
SOUP / DESSERT SPOON, OVAL  
L 181 mm L 7 in<sup>1/8</sup>



**126589**  
CUILLÈRE DE SERVICE  
SERVING SPOON  
L 252 mm L 9 in<sup>15/16</sup>



**126572**  
FOURCHETTE À DESSERT  
SALAD / DESSERT FORK  
L 181 mm L 7 in<sup>1/8</sup>



**126587**  
PELLE À TARTE MANCHE  
ORFÈVRE  
PASTRY SERVER, HOLLOW  
HANDLE  
L 250 mm L 9 in<sup>13/16</sup>



**126575**  
COUTEAU À DESSERT MANCHE  
ORFÈVRE LAME UNIE  
DESSERT KNIFE, HOLLOW  
HANDLE  
L 206 mm L 8 in<sup>1/8</sup>



**154828**  
COUTEAU À BEURRE MANCHE  
ORFÈVRE  
BUTTER KNIFE, HOLLOW  
HANDLE  
L 188 mm L 7 in<sup>3/8</sup>



18-10



POSSIBILITÉ DE PERSONNALISATION  
BESPOKE OPTIONS AVAILABLE



ÉGALEMENT DISPONIBLE EN MÉTAL ARGENTÉ SUR DEMANDE  
ALSO AVAILABLE IN SILVERPLATED FINISH ON DEMAND



# ACROPOLE NEW



**104262**  
**FOURCHETTE DE TABLE**  
TABLE FORK  
L 202 mm L 7 in<sup>15/16</sup>



**104261**  
**FOURCHETTE À POISSON**  
FISH FORK, 3 TINE  
L 181 mm L 7 in<sup>1/8</sup>



**104277**  
**COUTEAU DE TABLE MANCHE**  
**ORFÈVRE LAME SCIE**  
TABLE KNIFE, HOLLOW HANDLE,  
SERRATED  
L 231 mm L 9 in<sup>1/8</sup>



**104281**  
**COUTEAU À POISSON**  
FISH KNIFE  
L 201 mm L 7 in<sup>15/16</sup>



**104276**  
**CUILLÈRE DE TABLE**  
TABLE / PASTA SPOON  
L 207 mm L 8 in<sup>1/8</sup>



**104283**  
**CUILLÈRE À CAFÉ**  
COFFEE / TEASPOON  
L 139 mm L 5 in<sup>1/2</sup>



**104255**  
**CUILLÈRE À SOUPE ANGLAISE**  
BOUILLON SPOON, ROUND  
L 175 mm L 6 in<sup>7/8</sup>



**104256**  
**CUILLÈRE À MOKA**  
DEMITASSE / ESPRESSO  
SPOON  
L 111 mm L 4 in<sup>3/8</sup>



**104240**  
**CUILLÈRE À DESSERT**  
SOUP / DESSERT SPOON, OVAL  
L 181 mm L 7 in<sup>1/8</sup>



**104250**  
**FOURCHETTE À GÂTEAUX**  
COCKTAIL / PASTRY FORK  
L 140 mm L 5 in<sup>1/2</sup>



**104268**  
**FOURCHETTE À DESSERT**  
SALAD / DESSERT FORK  
L 181 mm L 7 in<sup>1/8</sup>



**024213**  
**FOURCHETTE DE SERVICE**  
SERVING FORK  
L 250 mm L 9 in<sup>13/16</sup>



**104275**  
**COUTEAU À DESSERT MANCHE**  
**ORFÈVRE LAME UNIE**  
DESSERT KNIFE, HOLLOW  
HANDLE  
L 206 mm L 8 in<sup>1/8</sup>



**024212**  
**CUILLÈRE DE SERVICE**  
SERVING SPOON  
L 252 mm L 9 in<sup>15/16</sup>



**247932**  
**COUTEAU À BEURRE MANCHE**  
**ORFÈVRE**  
BUTTER KNIFE, HOLLOW  
HANDLE  
L 188 mm L 7 in<sup>3/8</sup>



POSSIBILITÉ DE PERSONNALISATION  
BESPOKE OPTIONS AVAILABLE



ÉGALEMENT DISPONIBLE EN MÉTAL ARGENTÉ SUR DEMANDE  
ALSO AVAILABLE IN SILVERPLATED FINISH ON DEMAND





# BLOIS

MADE IN FRANCE



**104485\***  
FOURCHETTE DE TABLE  
TABLE FORK  
L 206 mm L 8 in<sup>1/8</sup>



**104484\***  
CUILLÈRE À DESSERT  
SOUP / DESSERT SPOON, OVAL  
L 178 mm L 7 in



**182466**  
COUTEAU DE TABLE  
MONOBLOC LAME SCIE  
TABLE KNIFE, 1 PC SOLID  
HANDLE, SERRATED  
L 246 mm L 9 in<sup>11/16</sup>



**104543\***  
FOURCHETTE À DESSERT  
SALAD / DESSERT FORK  
L 176 mm L 6 in<sup>15/16</sup>



**161391\***  
COUTEAU DE TABLE MANCHE  
ORFÈVRE LAME SCIE  
TABLE KNIFE, HOLLOW HANDLE,  
SERRATED  
L 246 mm L 9 in<sup>11/16</sup>



**182467**  
COUTEAU À DESSERT  
MONOBLOC LAME UNIE  
DESSERT KNIFE, 1 PC SOLID  
HANDLE  
L 211 mm L 8 in<sup>5/16</sup>



**161390**  
COUTEAU DE TABLE MANCHE  
ORFÈVRE LAME UNIE  
TABLE KNIFE, HOLLOW HANDLE  
L 246 mm L 9 in<sup>11/16</sup>



**161394\***  
COUTEAU À DESSERT MANCHE  
ORFÈVRE LAME UNIE  
DESSERT KNIFE, HOLLOW  
HANDLE  
L 206 mm L 8 in<sup>1/8</sup>



**122759**  
COUTEAU À STEAK MANCHE  
ORFÈVRE LAME SCIE  
STEAK KNIFE, HOLLOW  
HANDLE, SERRATED  
L 238 mm L 9 in<sup>3/8</sup>



**190419**  
COUTEAU À BEURRE  
MONOBLOC LAME UNIE  
BUTTER KNIFE, 1 PC SOLID  
HANDLE  
L 194 mm L 7 in<sup>5/8</sup>



**104526\***  
CUILLÈRE DE TABLE  
TABLE / PASTA SPOON  
L 206 mm L 8 in<sup>1/8</sup>



**122760**  
COUTEAU À BEURRE MANCHE  
ORFÈVRE  
BUTTER KNIFE, HOLLOW  
HANDLE  
L 187 mm L 7 in<sup>3/8</sup>



**104448**  
CUILLÈRE À SOUPE ANGLAISE  
BOUILLON SPOON, ROUND  
L 174 mm L 6 in<sup>7/8</sup>



18-10



3,5

POSSIBILITÉ DE PERSONNALISATION  
BESPOKE OPTIONS AVAILABLE



ÉGALEMENT DISPONIBLE EN MÉTAL ARGENTÉ SUR STOCK\*  
ALSO AVAILABLE IN SILVERPLATED FINISH ON STOCK

SUITE PAGE 17  
FOLLOWING PAGE 17



# BLOIS

MADE IN FRANCE



**104507**  
**FOURCHETTE À POISSON**  
FISH FORK, 3 TINE  
L 176 mm L 6 in<sup>15/16</sup>



**104508**  
**COUTEAU À POISSON**  
FISH KNIFE  
L 198 mm L 7 in<sup>13/16</sup>



**145451**  
**CUILLÈRE À SAUCE GOURMET**  
GOURMET SAUCE SPOON, FLAT  
L 179 mm L 7 in<sup>17/16</sup>



**104561\***  
**CUILLÈRE À CAFÉ**  
COFFEE / TEASPOON  
L 138 mm L 5 in<sup>7/16</sup>



**161398\***  
**CUILLÈRE À MOKA**  
DEMITASSE / ESPRESSO  
SPOON  
L 110 mm L 4 in<sup>57/16</sup>



**124259**  
**CUILLÈRE À SODA**  
ICED TEASPOON / LONGDRINK  
L 180 mm L 7 in<sup>17/16</sup>



**104480**  
**FOURCHETTE À GÂTEAUX**  
COCKTAIL / PASTRY FORK  
L 138 mm L 5 in<sup>77/16</sup>



**104463**  
**FOURCHETTE À HÙÎTRES**  
OYSTER / SHELLFISH FORK  
L 130 mm L 5 in<sup>17/8</sup>



**189208**  
**COUTEAU À FROMAGE MANCHE**  
ORFÈVRE LAME UNIE  
CHEESE KNIFE, HOLLOW  
HANDLE, HOOKED  
L 194 mm L 7 in<sup>57/8</sup>



**195757**  
**FOURCHETTE DE SERVICE**  
SERVING FORK  
L 247 mm L 9 in<sup>37/4</sup>



**195755**  
**CUILLÈRE DE SERVICE**  
SERVING SPOON  
L 249 mm L 9 in<sup>13/16</sup>



**195757**  
**FOURCHETTE À DÉCOUPER**  
CARVING FORK  
L 247 mm L 9 in<sup>37/4</sup>



**189511**  
**COUTEAU À DECOUPER**  
MANCHE ORFÈVRE LAME UNIE  
CARVING KNIFE, HOLLOW  
HANDLE  
L 286 mm L 11 in<sup>17/4</sup>



**195750**  
**COUVERTS À SALADE**  
SALAD SERVING SET, 2 PCS  
L 257 mm L 10 in<sup>17/8</sup>



**195753**  
**PELLE À TARTE**  
PASTRY SERVER, SOLID  
HANDLE  
L 251 mm L 9 in<sup>77/8</sup>



**195762**  
**LOUCHE**  
SOUP LADLE  
L 286 mm L 11 in<sup>17/4</sup>



**195759**  
**LOUCHE À SAUCE**  
SAUCE LADLE  
L 160 mm L 6 in<sup>57/8</sup>



18-10



3,5

POSSIBILITÉ DE PERSONNALISATION  
BESPOKE OPTIONS AVAILABLE



ÉGALEMENT DISPONIBLE EN MÉTAL ARGENTÉ SUR STOCK\*  
ALSO AVAILABLE IN SILVERPLATED FINISH ON STOCK



# CONFIDENCE



**141094**  
**FOURCHETTE DE TABLE**  
TABLE FORK  
L 203 mm L 8 in



**103857**  
**COUTEAU DE TABLE**  
**MONOBLOC LAME SCIE**  
TABLE KNIFE, 1 PC SOLID  
HANDLE, SERRATED  
L 239 mm L 9 in<sup>7/16</sup>



**160433**  
**COUTEAU À STEAK MONOBLOC**  
**LAME SCIE**  
STEAK KNIFE, 1 PC SOLID  
HANDLE, SERRATED  
L 239 mm L 9 in<sup>7/16</sup>



**141092**  
**CUILLÈRE DE TABLE**  
TABLE / PASTA SPOON  
L 202 mm L 7 in<sup>15/16</sup>



**108232**  
**CUILLÈRE À DESSERT**  
SOUP / DESSERT SPOON, OVAL  
L 179 mm L 7 in<sup>7/16</sup>



**108234**  
**FOURCHETTE À DESSERT**  
SALAD / DESSERT FORK  
L 178 mm L 7 in



**210628**  
**COUTEAU À DESSERT**  
**MONOBLOC LAME SCIE**  
DESSERT KNIFE, 1 PC SOLID  
HANDLE, SERRATED  
L 206 mm L 8 in<sup>1/8</sup>



**103564**  
**CUILLÈRE À CAFÉ**  
COFFEE / TEASPOON  
L 135 mm L 5 in<sup>5/16</sup>



**109471**  
**CUILLÈRE À MOKA**  
DEMITASSE / ESPRESSO  
SPOON  
L 110 mm L 4 in<sup>5/16</sup>



**132782**  
**FOURCHETTE À ESCARGOTS**  
SNAIL FORK, 2 TINE  
L 135 mm L 5 in<sup>5/16</sup>

## SUGGESTION PIÈCES COMPLÉMENTAIRES SUGGESTED ADDITIONAL PIECES VERLAINE



**105908**  
**CUILLÈRE À SOUPE ANGLAISE**  
BOUILLON SPOON, ROUND  
L 173 mm L 6 in<sup>13/16</sup>



**105800**  
**CUILLÈRE À SODA**  
ICED TEASPOON / LONGDRINK  
L 179 mm L 7 in<sup>1/16</sup>



**002185**  
**FOURCHETTE DE SERVICE**  
SERVING FORK  
L 248 mm L 9 in<sup>3/4</sup>



**002186**  
**CUILLÈRE DE SERVICE**  
SERVING SPOON  
L 250 mm L 9 in<sup>13/16</sup>



**040646**  
**COUVERTS À SALADE**  
SALAD SERVING SET, 2 PCS  
L 257 mm L 10 in<sup>1/8</sup>



**083340**  
**PELLE À TARTE**  
PASTRY SERVER, SOLID  
HANDLE  
L 251 mm L 9 in<sup>7/8</sup>



**097717**  
**LOUCHE**  
SOUP LADLE  
L 305 mm L 12 in



**002179**  
**LOUCHE À SAUCE**  
SAUCE LADLE  
L 156 mm L 6 in<sup>1/8</sup>



POSSIBILITÉ DE PERSONNALISATION  
BESPOKE OPTIONS AVAILABLE



ÉGALEMENT DISPONIBLE EN MÉTAL ARGENTÉ SUR DEMANDE  
ALSO AVAILABLE IN SILVERPLATED FINISH ON DEMAND



# CONTOUR

MADE IN FRANCE



**104729**  
**FOURCHETTE DE TABLE**  
TABLE FORK  
L 208 mm L 8 in<sup>3/16</sup>



**104728**  
**COUTEAU DE TABLE MANCHE ORFÈVRE LAME SCIE**  
TABLE KNIFE, HOLLOW HANDLE, SERRATED  
L 249 mm L 9 in<sup>13/16</sup>



**104712**  
**CUILLÈRE DE TABLE**  
TABLE / PASTA SPOON  
L 210 mm L 8 in<sup>1/4</sup>



**186291**  
**CUILLÈRE À SOUPE ANGLAISE**  
BOUILLON SPOON, ROUND  
L 175 mm L 6 in<sup>7/8</sup>



**104752**  
**CUILLÈRE À DESSERT**  
SOUP / DESSERT SPOON, OVAL  
L 181 mm L 7 in<sup>1/8</sup>



**104765**  
**FOURCHETTE À DESSERT**  
SALAD / DESSERT FORK  
L 179 mm L 7 in<sup>1/16</sup>



**104779**  
**COUTEAU À DESSERT MANCHE ORFÈVRE LAME UNIE**  
DESSERT KNIFE, HOLLOW HANDLE  
L 208 mm L 8 in<sup>3/16</sup>



**186294**  
**COUTEAU À BEURRE MANCHE ORFÈVRE**  
BUTTER KNIFE, HOLLOW HANDLE  
L 191 mm L 7 in<sup>1/2</sup>



**104766**  
**CUILLÈRE À CAFÉ**  
COFFEE / TEASPOON  
L 141 mm L 5 in<sup>9/16</sup>



**104707**  
**FOURCHETTE À POISSON**  
FISH FORK, 3 TINE  
L 179 mm L 7 in<sup>1/16</sup>



**104727**  
**COUTEAU À POISSON**  
FISH KNIFE  
L 201 mm L 7 in<sup>15/16</sup>



**186290 <sup>NEW</sup>**  
**FOURCHETTE À GÂTEAUX**  
COCKTAIL / PASTRY FORK  
L 140 mm L 5 in<sup>1/2</sup>



18-10



3,5

POSSIBILITÉ DE PERSONNALISATION  
BESPOKE OPTIONS AVAILABLE



ÉGALEMENT DISPONIBLE EN MÉTAL ARGENTÉ SUR DEMANDE  
ALSO AVAILABLE IN SILVERPLATED FINISH ON DEMAND





# EMPIRE NEW

MADE IN FRANCE



**182958**  
**FOURCHETTE DE TABLE**  
TABLE FORK  
L 207 mm L 8 in<sup>1/8</sup>



**182962**  
**FOURCHETTE À POISSON**  
FISH FORK, 3 TINE  
L 177 mm L 6 in<sup>15/16</sup>



**182960**  
**COUTEAU DE TABLE MANCHE**  
**ORFÈVRE LAME SCIE**  
TABLE KNIFE, HOLLOW HANDLE,  
SERRATED  
L 247 mm L 9 in<sup>3/4</sup>



**182963**  
**COUTEAU À POISSON**  
FISH KNIFE  
L 199 mm L 7 in<sup>13/16</sup>



**182957**  
**CUILLÈRE DE TABLE**  
TABLE / PASTA SPOON  
L 207 mm L 8 in<sup>1/8</sup>



**182959**  
**CUILLÈRE À CAFÉ**  
COFFEE / TEASPOON  
L 139 mm L 5 in<sup>7/12</sup>



**188963**  
**CUILLÈRE À SOUPE ANGLAISE**  
BOUILLON SPOON, ROUND  
L 173 mm L 6 in<sup>13/16</sup>



**182966**  
**CUILLÈRE À MOKA**  
DEMITASSE / ESPRESSO SPOON  
L 110 mm L 4 in<sup>3/16</sup>



**182964**  
**CUILLÈRE À DESSERT**  
SOUP / DESSERT SPOON, OVAL  
L 177 mm L 6 in<sup>15/16</sup>



**186517**  
**FOURCHETTE À GÂTEAUX**  
COCKTAIL / PASTRY FORK  
L 138 mm L 5 in<sup>7/16</sup>



**182965**  
**FOURCHETTE À DESSERT**  
SALAD / DESSERT FORK  
L 177 mm L 6 in<sup>15/16</sup>

## SUGGESTION PIÈCES COMPLÉMENTAIRES SUGGESTED ADDITIONAL PIECES VERLAINE



**002185**  
**FOURCHETTE DE SERVICE**  
SERVING FORK  
L 248 mm L 9 in<sup>3/4</sup>



**182961**  
**COUTEAU À DESSERT MANCHE**  
**ORFÈVRE LAME UNIE**  
DESSERT KNIFE, HOLLOW  
HANDLE  
L 206 mm L 8 in<sup>1/8</sup>



**002186**  
**CUILLÈRE DE SERVICE**  
SERVING SPOON  
L 250 mm L 9 in<sup>13/16</sup>



**186314**  
**COUTEAU À BEURRE MANCHE**  
**ORFÈVRE**  
BUTTER KNIFE, HOLLOW  
HANDLE  
L 187 mm L 7 in<sup>3/8</sup>



**040646**  
**COUVERTS À SALADE**  
SALAD SERVING SET, 2 PCS  
L 257 mm L 10 in<sup>1/8</sup>



**083340**  
**PELLE À TARTE**  
PASTRY SERVER, SOLID  
HANDLE  
L 251 mm L 9 in<sup>7/8</sup>



**097717**  
**LOUCHE**  
SOUP LADLE  
L 305 mm L 12 in



**002179**  
**LOUCHE À SAUCE**  
SAUCE LADLE  
L 156 mm L 6 in<sup>1/8</sup>



18-10



3,5

POSSIBILITÉ DE PERSONNALISATION  
BESPOKE OPTIONS AVAILABLE



ÉGALEMENT DISPONIBLE EN MÉTAL ARGENTÉ SUR DEMANDE  
ALSO AVAILABLE IN SILVERPLATED FINISH ON DEMAND



# FLORENCIA

MADE IN FRANCE



**126077**  
**FOURCHETTE DE TABLE**  
TABLE FORK  
L 207 mm L 8 in<sup>7/8</sup>



**190643**  
**COUTEAU DE TABLE**  
**MONOBLOC LAME SCIE**  
TABLE KNIFE, 1 PC SOLID  
HANDLE, SERRATED  
L 247 mm L 9 in<sup>3/4</sup>



**130140**  
**COUTEAU DE TABLE MANCHE**  
**ORFÈVRE LAME SCIE**  
TABLE KNIFE, HOLLOW HANDLE,  
SERRATED  
L 246 mm L 9 in<sup>11/16</sup>



**127654**  
**COUTEAU À STEAK MANCHE**  
**ORFÈVRE LAME SCIE**  
STEAK KNIFE, HOLLOW  
HANDLE, SERRATED  
L 238 mm L 9 in<sup>3/8</sup>



**126074**  
**CUILLÈRE DE TABLE**  
TABLE / PASTA SPOON  
L 207 mm L 8 in<sup>1/8</sup>



**126090**  
**CUILLÈRE À DESSERT**  
SOUP / DESSERT SPOON, OVAL  
L 177 mm L 6 in<sup>15/16</sup>



**126093**  
**FOURCHETTE À DESSERT**  
SALAD / DESSERT FORK  
L 177 mm L 6 in<sup>15/16</sup>



**190644**  
**COUTEAU À DESSERT**  
**MONOBLOC LAME UNIE**  
DESSERT KNIFE, 1 PC SOLID  
HANDLE  
L 211 mm L 8 in<sup>5/16</sup>



**126096**  
**COUTEAU À DESSERT MANCHE**  
**ORFÈVRE LAME UNIE**  
DESSERT KNIFE, HOLLOW  
HANDLE  
L 208 mm L 8 in<sup>3/16</sup>



**190417**  
**COUTEAU À BEURRE**  
**MONOBLOC LAME UNIE**  
BUTTER KNIFE, 1 PC SOLID  
HANDLE  
L 189 mm L 7 in<sup>7/16</sup>



**129344**  
**COUTEAU À BEURRE MANCHE**  
**ORFÈVRE**  
BUTTER KNIFE, HOLLOW  
HANDLE  
L 190 mm L 7 in<sup>1/2</sup>



**126099**  
**FOURCHETTE À POISSON**  
FISH FORK, 3 TINE  
L 177 mm L 6 in<sup>15/16</sup>



**126102**  
**COUTEAU À POISSON**  
FISH KNIFE  
L 199 mm L 7 in<sup>13/16</sup>



**126080**  
**CUILLÈRE À CAFÉ**  
COFFEE / TEASPOON  
L 139 mm L 5 in<sup>1/2</sup>



**126105**  
**CUILLÈRE À MOKA**  
DEMITASSE / ESPRESSO  
SPOON  
L 110 mm L 4 in<sup>5/16</sup>



**126108**  
**FOURCHETTE À GÂTEAUX**  
COCKTAIL / PASTRY FORK  
L 138 mm L 5 in<sup>7/16</sup>



**190418**  
**FOURCHETTE À HÛÎTRES**  
OYSTER / SHELLFISH FORK  
L 130 mm L 5 in<sup>1/8</sup>

## SUGGESTION PIÈCES COMPLÉMENTAIRES SUGGESTED ADDITIONAL PIECES VERLAINE



**002185**  
**FOURCHETTE DE SERVICE**  
SERVING FORK  
L 248 mm L 9 in<sup>3/4</sup>



**002186**  
**CUILLÈRE DE SERVICE**  
SERVING SPOON  
L 250 mm L 9 in<sup>13/16</sup>



**040646**  
**COUVERTS À SALADE**  
SALAD SERVING SET, 2 PCS  
L 257 mm L 10 in<sup>1/8</sup>



**083340**  
**PELLE À TARTE**  
PASTRY SERVER, SOLID  
HANDLE  
L 251 mm L 9 in<sup>7/8</sup>



**097717**  
**LOUCHE**  
SOUP LADLE  
L 305 mm L 12 in



**002179**  
**LOUCHE À SAUCE**  
SAUCE LADLE  
L 156 mm L 6 in<sup>1/8</sup>



18-10



3,5

POSSIBILITÉ DE PERSONNALISATION  
BESPOKE OPTIONS AVAILABLE



ÉGALEMENT DISPONIBLE EN MÉTAL ARGENTÉ SUR DEMANDE  
ALSO AVAILABLE IN SILVERPLATED FINISH ON DEMAND



GUY DEGRENNE



**248657**  
**FOURCHETTE DE TABLE**  
 TABLE FORK  
 L 209 mm L 8 in<sup>1/4</sup>



**248663**  
**COUTEAU DE TABLE**  
**MONOBLOC LAME SCIE**  
 TABLE KNIFE, 1 PC SOLID  
 HANDLE, SERRATED  
 L 239 mm L 9 in<sup>7/16</sup>



**248661**  
**COUTEAU DE TABLE MANCHE**  
**ORFÈVRE LAME UNIE**  
 TABLE KNIFE, HOLLOW HANDLE  
 L 239 mm L 9 in<sup>7/16</sup>  
 DISPONIBILITÉ 2<sup>ND</sup> SEM. 2026  
 AVAILABILITY 2<sup>ND</sup> SEM. 2026



**248655**  
**CUILLÈRE DE TABLE**  
 TABLE / PASTA SPOON  
 L 210 mm L 8 in<sup>1/4</sup>



**248683**  
**CUILLÈRE À SOUPE ANGLAISE**  
 BOUILLON SPOON, ROUND  
 L 175 mm L 6 in<sup>7/8</sup>



**248667**  
**CUILLÈRE À DESSERT**  
 SOUP / DESSERT SPOON, OVAL  
 L 180 mm L 7 in<sup>1/16</sup>



**248665**  
**FOURCHETTE À DESSERT**  
 SALAD / DESSERT FORK  
 L 180 mm L 7 in<sup>1/16</sup>



**248671**  
**COUTEAU À DESSERT**  
**MONOBLOC LAME UNIE**  
 DESSERT KNIFE, 1 PC SOLID  
 HANDLE  
 L 210 mm L 8 in<sup>1/4</sup>



**248669**  
**COUTEAU À DESSERT MANCHE**  
**ORFÈVRE LAME UNIE**  
 DESSERT KNIFE, HOLLOW  
 HANDLE  
 L 203 mm L 8 in  
 DISPONIBILITÉ 2<sup>ND</sup> SEM. 2026  
 AVAILABILITY 2<sup>ND</sup> SEM. 2026



**248679**  
**COUTEAU À BEURRE**  
**MONOBLOC LAME UNIE**  
 BUTTER KNIFE, 1 PC SOLID  
 HANDLE  
 L 180 mm L 7 in<sup>1/16</sup>



**248681**  
**COUTEAU À BEURRE MANCHE**  
**ORFÈVRE**  
 BUTTER KNIFE, HOLLOW  
 HANDLE  
 L 175 mm L 6 in<sup>7/8</sup>  
 DISPONIBILITÉ 2<sup>ND</sup> SEM. 2026  
 AVAILABILITY 2<sup>ND</sup> SEM. 2026



**248675**  
**FOURCHETTE À POISSON**  
 FISH FORK, 3 TINE  
 L 180 mm L 7 in<sup>1/16</sup>



**248677**  
**COUTEAU À POISSON**  
 FISH KNIFE  
 L 198 mm L 7 in<sup>13/16</sup>



**248659**  
**CUILLÈRE À CAFÉ**  
 COFFEE / TEASPOON  
 L 141 mm L 5 in<sup>3/16</sup>



**248673**  
**CUILLÈRE À MOKA**  
 DEMITASSE / ESPRESSO  
 SPOON  
 L 108 mm L 4 in<sup>1/4</sup>



**248685**  
**FOURCHETTE À GÂTEAUX**  
 COCKTAIL / PASTRY FORK  
 L 137 mm L 5 in<sup>3/8</sup>



# LUTÈCE

MADE IN FRANCE



**105021**  
FOURCHETTE DE TABLE  
TABLE FORK  
L 207 mm L 8 in<sup>7/8</sup>



**190414**  
COUTEAU À BEURRE  
MONOBLOC LAME UNIE  
BUTTER KNIFE, 1 PC SOLID  
HANDLE  
L 194 mm L 7 in<sup>5/8</sup>



**190415**  
COUTEAU DE TABLE  
MONOBLOC LAME SCIE  
TABLE KNIFE, 1 PC SOLID  
HANDLE, SERRATED  
L 244 mm L 9 in<sup>5/8</sup>



**016394**  
COUTEAU À BEURRE MANCHE  
ORFÈVRE  
BUTTER KNIFE, HOLLOW  
HANDLE  
L 189 mm L 7 in<sup>7/16</sup>



**105006**  
COUTEAU DE TABLE MANCHE  
ORFÈVRE LAME SCIE  
TABLE KNIFE, HOLLOW HANDLE,  
SERRATED  
L 246 mm L 9 in<sup>11/16</sup>



**104994**  
FOURCHETTE À POISSON  
FISH FORK, 3 TINE  
L 178 mm L 7 in



**122746**  
COUTEAU À STEAK MANCHE  
ORFÈVRE LAME SCIE  
STEAK KNIFE, HOLLOW  
HANDLE, SERRATED  
L 238 mm L 9 in<sup>3/8</sup>



**104995**  
COUTEAU À POISSON  
FISH KNIFE  
L 198 mm L 7 in<sup>13/16</sup>



**104988**  
CUILLÈRE DE TABLE  
TABLE / PASTA SPOON  
L 210 mm L 8 in<sup>1/4</sup>



**104977**  
CUILLÈRE À SAUCE GOURMET  
GOURMET SAUCE SPOON, FLAT  
L 180 mm L 7 in<sup>1/16</sup>



**104975**  
CUILLÈRE À SOUPE ANGLAISE  
BOUILLON SPOON, ROUND  
L 174 mm L 6 in<sup>7/8</sup>



**104986**  
CUILLÈRE À CAFÉ  
COFFEE / TEASPOON  
L 140 mm L 5 in<sup>1/2</sup>



**104985**  
CUILLÈRE À DESSERT  
SOUP / DESSERT SPOON, OVAL  
L 180 mm L 7 in<sup>1/16</sup>



**104993**  
CUILLÈRE À MOKA  
DEMITASSE / ESPRESSO  
SPOON  
L 109 mm L 4 in<sup>5/16</sup>



**105013**  
FOURCHETTE À DESSERT  
SALAD / DESSERT FORK  
L 178 mm L 7 in



**105012**  
FOURCHETTE À GÂTEAUX  
COCKTAIL / PASTRY FORK  
L 138 mm L 5 in<sup>7/16</sup>



**190416**  
COUTEAU À DESSERT  
MONOBLOC LAME UNIE  
DESSERT KNIFE, 1 PC SOLID  
HANDLE  
L 211 mm L 8 in<sup>5/16</sup>



**104989**  
COUTEAU À DESSERT MANCHE  
ORFÈVRE LAME UNIE  
DESSERT KNIFE, HOLLOW  
HANDLE  
L 206 mm L 8 in<sup>1/8</sup>



18-10



3,5

POSSIBILITÉ DE PERSONNALISATION  
BESPOKE OPTIONS AVAILABLE



ÉGALEMENT DISPONIBLE EN MÉTAL ARGENTÉ SUR DEMANDE  
ALSO AVAILABLE IN SILVERPLATED FINISH ON DEMAND





# MARQUISE



**182968\***  
**FOURCHETTE DE TABLE**  
TABLE FORK  
L 207 mm L 8 in<sup>1/8</sup>



**182972**  
**FOURCHETTE À POISSON**  
FISH FORK, 3 TINE  
L 177 mm L 6 in<sup>15/16</sup>



**182970\***  
**COUTEAU DE TABLE MANCHE ORFÈVRE LAME SCIE**  
TABLE KNIFE, HOLLOW HANDLE, SERRATED  
L 247 mm L 9 in<sup>3/4</sup>



**182973**  
**COUTEAU À POISSON**  
FISH KNIFE  
L 199 mm L 7 in<sup>13/16</sup>



**186278**  
**COUTEAU À STEAK MANCHE ORFÈVRE LAME SCIE**  
STEAK KNIFE, HOLLOW HANDLE, SERRATED  
L 238 mm L 9 in<sup>3/8</sup>



**182969\***  
**CUILLÈRE À CAFÉ**  
COFFEE / TEASPOON  
L 139 mm L 5 in<sup>1/2</sup>



**182967\***  
**CUILLÈRE DE TABLE**  
TABLE / PASTA SPOON  
L 207 mm L 8 in<sup>1/8</sup>



**182976\***  
**CUILLÈRE À MOKA**  
DEMITASSE / ESPRESSO SPOON  
L 110 mm L 4 in<sup>5/16</sup>



**186276**  
**CUILLÈRE À SOUPE ANGLAISE**  
BOUILLON SPOON, ROUND  
L 174 mm L 6 in<sup>7/8</sup>



**186274**  
**FOURCHETTE À GÂTEAUX**  
COCKTAIL / PASTRY FORK  
L 138 mm L 5 in<sup>7/16</sup>



**182974\***  
**CUILLÈRE À DESSERT**  
SOUP / DESSERT SPOON, OVAL  
L 177 mm L 6 in<sup>15/16</sup>



**190681**  
**FOURCHETTE À HÙITRES**  
OYSTER / SHELLFISH FORK  
L 130 mm L 5 in<sup>1/8</sup>



**182975\***  
**FOURCHETTE À DESSERT**  
SALAD / DESSERT FORK  
L 177 mm L 6 in<sup>15/16</sup>

## SUGGESTION PIÈCES COMPLÉMENTAIRES SUGGESTED ADDITIONAL PIECES

### VERLAINE



**002185**  
**FOURCHETTE DE SERVICE**  
SERVING FORK  
L 248 mm L 9 in<sup>3/4</sup>



**182971\***  
**COUTEAU À DESSERT MANCHE ORFÈVRE LAME UNIE**  
DESSERT KNIFE, HOLLOW HANDLE  
L 206 mm L 8 in<sup>1/8</sup>



**002186**  
**CUILLÈRE DE SERVICE**  
SERVING SPOON  
L 250 mm L 9 in<sup>13/16</sup>



**186279**  
**COUTEAU À BEURRE MANCHE ORFÈVRE**  
BUTTER KNIFE, HOLLOW HANDLE  
L 187 mm L 7 in<sup>3/8</sup>



**040646**  
**COUVERTS À SALADE**  
SALAD SERVING SET, 2 PCS  
L 257 mm L 10 in<sup>1/8</sup>



**083340**  
**PELLE À TARTE**  
PASTRY SERVER, SOLID HANDLE  
L 251 mm L 9 in<sup>7/8</sup>



**097717**  
**LOUCHE**  
SOUP LADLE  
L 305 mm L 12 in



**002179**  
**LOUCHE À SAUCE**  
SAUCE LADLE  
L 156 mm L 6 in<sup>1/8</sup>



POSSIBILITÉ DE PERSONNALISATION  
BESPOKE OPTIONS AVAILABLE



ÉGALEMENT DISPONIBLE EN MÉTAL ARGENTÉ SUR STOCK\*  
ALSO AVAILABLE IN SILVERPLATED FINISH ON STOCK



# MIKADO



**141089**  
**FOURCHETTE DE TABLE**  
TABLE FORK  
L 202 mm L 7 in<sup>15/16</sup>



**113017**  
**COUTEAU DE TABLE**  
**MONOBLOC LAME SCIE**  
TABLE KNIFE, 1 PC SOLID  
HANDLE, SERRATED  
L 244 mm L 9 in<sup>5/8</sup>



**160427**  
**COUTEAU À STEAK MONOBLOC**  
**LAME SCIE**  
STEAK KNIFE, 1 PC SOLID  
HANDLE, SERRATED  
L 239 mm L 9 in<sup>7/16</sup>



**141086**  
**CUILLÈRE DE TABLE**  
TABLE / PASTA SPOON  
L 202 mm L 7 in<sup>15/16</sup>



**108236**  
**CUILLÈRE À DESSERT**  
SOUP / DESSERT SPOON, OVAL  
L 179 mm L 7 in<sup>1/16</sup>



**108238**  
**FOURCHETTE À DESSERT**  
SALAD / DESSERT FORK  
L 178 mm L 7 in



**113019**  
**COUTEAU À DESSERT**  
**MONOBLOC LAME UNIE**  
DESSERT KNIFE, 1 PC SOLID  
HANDLE  
L 210 mm L 8 in<sup>1/4</sup>



**103550**  
**CUILLÈRE À CAFÉ**  
COFFEE / TEASPOON  
L 135 mm L 5 in<sup>5/16</sup>



**109465**  
**CUILLÈRE À MOKA**  
DEMITASSE / ESPRESSO  
SPOON  
L 110 mm L 4 in<sup>5/16</sup>

## SUGGESTION PIÈCES COMPLÉMENTAIRES SUGGESTED ADDITIONAL PIECES

### BLOIS



**104448**  
**CUILLÈRE À SOUPE ANGLAISE**  
BOUILLON SPOON, ROUND  
L 174 mm L 6 in<sup>7/8</sup>



**190419**  
**COUTEAU À BEURRE**  
**MONOBLOC LAME UNIE**  
BUTTER KNIFE, 1 PC SOLID  
HANDLE  
L 194 mm L 7 in<sup>5/8</sup>



**104507**  
**FOURCHETTE À POISSON**  
FISH FORK, 3 TINE  
L 176 mm L 6 in<sup>15/16</sup>



**104508**  
**COUTEAU À POISSON**  
FISH KNIFE  
L 198 mm L 7 in<sup>13/16</sup>



**124259**  
**CUILLÈRE À SODA**  
ICED TEASPOON / LONGDRINK  
L 180 mm L 7 in<sup>1/16</sup>



**104480**  
**FOURCHETTE À GÂTEAUX**  
COCKTAIL / PASTRY FORK  
L 138 mm L 5 in<sup>7/16</sup>



**104463**  
**FOURCHETTE À HÙITRES**  
OYSTER / SHELLFISH FORK  
L 130 mm L 5 in<sup>1/8</sup>



**195757**  
**FOURCHETTE DE SERVICE**  
SERVING FORK  
L 247 mm L 9 in<sup>3/4</sup>



**195755**  
**CUILLÈRE DE SERVICE**  
SERVING SPOON  
L 249 mm L 9 in<sup>13/16</sup>



**195750**  
**COUVERTS À SALADE**  
SALAD SERVING SET, 2 PCS  
L 257 mm L 10 in<sup>1/8</sup>



**195753**  
**PELLE À TARTE**  
PASTRY SERVER, SOLID  
HANDLE  
L 251 mm L 9 in<sup>7/8</sup>



**195762**  
**LOUCHE**  
SOUP LADLE  
L 286 mm L 11 in<sup>1/4</sup>



**195759**  
**LOUCHE À SAUCE**  
SAUCE LADLE  
L 160 mm L 6 in<sup>5/16</sup>



POSSIBILITÉ DE PERSONNALISATION  
BESPOKE OPTIONS AVAILABLE



ÉGALEMENT DISPONIBLE EN MÉTAL ARGENTÉ SUR DEMANDE  
ALSO AVAILABLE IN SILVERPLATED FINISH ON DEMAND



# MIKADO VINTAGE



**230285**  
**FOURCHETTE DE TABLE**  
TABLE FORK  
L 202 mm L 7 in<sup>15/16</sup>



**230287**  
**COUTEAU DE TABLE MONOBLOC LAME SCIE**  
TABLE KNIFE, 1 PC SOLID HANDLE, SERRATED  
L 244 mm L 9 in<sup>5/8</sup>



**230293**  
**COUTEAU À STEAK MONOBLOC LAME SCIE**  
STEAK KNIFE, 1 PC SOLID HANDLE, SERRATED  
L 239 mm L 9 in<sup>7/16</sup>



**230286**  
**CUILLÈRE DE TABLE**  
TABLE / PASTA SPOON  
L 202 mm L 7 in<sup>15/16</sup>



**230291**  
**CUILLÈRE À DESSERT**  
SOUP / DESSERT SPOON, OVAL  
L 179 mm L 7 in<sup>1/16</sup>



**230290**  
**FOURCHETTE À DESSERT**  
SALAD / DESSERT FORK  
L 178 mm L 7 in



**230292**  
**COUTEAU À DESSERT MONOBLOC LAME UNIE**  
DESSERT KNIFE, 1 PC SOLID HANDLE  
L 210 mm L 8 in<sup>1/4</sup>



**230288**  
**CUILLÈRE À CAFÉ**  
COFFEE / TEASPOON  
L 135 mm L 5 in<sup>5/16</sup>



**230289**  
**CUILLÈRE À MOKA**  
DEMITASSE / ESPRESSO SPOON  
L 110 mm L 4 in<sup>5/16</sup>



18-10



ARTICLES SUPPLÉMENTAIRES DE FINITION VINTAGE DISPONIBLE SUR DEMANDE  
ADDITIONAL VINTAGE FINISH ITEMS AVAILABLE ON DEMAND



# MILADY

MADE IN FRANCE



**127442**  
**FOURCHETTE DE TABLE**  
TABLE FORK  
L 207 mm L 8 in<sup>1/8</sup>



**226578**  
**COUTEAU DE TABLE**  
**MONOBLOC LAME SCIE**  
TABLE KNIFE, 1 PC SOLID  
HANDLE, SERRATED  
L 244 mm L 9 in<sup>5/8</sup>



**139158**  
**COUTEAU DE TABLE MANCHE**  
**ORFÈVRE LAME SCIE**  
TABLE KNIFE, HOLLOW HANDLE,  
SERRATED  
L 247 mm L 9 in<sup>3/4</sup>



**128841**  
**COUTEAU À STEAK MANCHE**  
**ORFÈVRE LAME SCIE**  
STEAK KNIFE, HOLLOW  
HANDLE, SERRATED  
L 238 mm L 9 in<sup>3/8</sup>



**127439**  
**CUILLÈRE DE TABLE**  
TABLE / PASTA SPOON  
L 207 mm L 8 in<sup>1/8</sup>



**127464**  
**CUILLÈRE À DESSERT**  
SOUP / DESSERT SPOON, OVAL  
L 177 mm L 6 in<sup>15/16</sup>



**127467**  
**FOURCHETTE À DESSERT**  
SALAD / DESSERT FORK  
L 177 mm L 6 in<sup>15/16</sup>



**226579**  
**COUTEAU À DESSERT**  
**MONOBLOC LAME UNIE**  
DESSERT KNIFE, 1 PC SOLID  
HANDLE  
L 211 mm L 8 in<sup>5/16</sup>



**127470**  
**COUTEAU À DESSERT MANCHE**  
**ORFÈVRE LAME UNIE**  
DESSERT KNIFE, HOLLOW  
HANDLE  
L 206 mm L 8 in<sup>1/8</sup>



**226580**  
**COUTEAU À BEURRE**  
**MONOBLOC LAME UNIE**  
BUTTER KNIFE, 1 PC SOLID  
HANDLE  
L 190 mm L 7 in<sup>1/2</sup>



**122769**  
**COUTEAU À BEURRE MANCHE**  
**ORFÈVRE**  
BUTTER KNIFE, HOLLOW  
HANDLE  
L 187 mm L 7 in<sup>3/8</sup>



**127473**  
**FOURCHETTE À POISSON**  
FISH FORK, 3 TINE  
L 177 mm L 6 in<sup>15/16</sup>



**127477**  
**COUTEAU À POISSON**  
FISH KNIFE  
L 199 mm L 7 in<sup>13/16</sup>



**130542**  
**CUILLÈRE À SAUCE GOURMET**  
GOURMET SAUCE SPOON, FLAT  
L 179 mm L 7 in<sup>1/4</sup>



**127455**  
**CUILLÈRE À CAFÉ**  
COFFEE / TEASPOON  
L 139 mm L 5 in<sup>1/2</sup>



**127479**  
**CUILLÈRE À MOKA**  
DEMITASSE / ESPRESSO  
SPOON  
L 110 mm L 4 in<sup>5/16</sup>



**127482**  
**FOURCHETTE À GÂTEAUX**  
COCKTAIL / PASTRY FORK  
L 138 mm L 5 in<sup>7/16</sup>



**130266**  
**FOURCHETTE À HÙITRES**  
OYSTER / SHELLFISH FORK  
L 130 mm L 5 in<sup>1/8</sup>

## SUGGESTION PIÈCES COMPLÉMENTAIRES SUGGESTED ADDITIONAL PIECES

### VERLAINE



**002185**  
**FOURCHETTE DE SERVICE**  
SERVING FORK  
L 248 mm L 9 in<sup>3/4</sup>



**002186**  
**CUILLÈRE DE SERVICE**  
SERVING SPOON  
L 250 mm L 9 in<sup>13/16</sup>



**040646**  
**COUVERTS À SALADE**  
SALAD SERVING SET, 2 PCS  
L 257 mm L 10 in<sup>1/8</sup>



**083340**  
**PELLE À TARTE**  
PASTRY SERVER, SOLID HANDLE  
L 251 mm L 9 in<sup>7/8</sup>



**097717**  
**LOUCHE**  
SOUP LADLE  
L 305 mm L 12 in



**002179**  
**LOUCHE À SAUCE**  
SAUCE LADLE  
L 156 mm L 6 in<sup>1/8</sup>



POSSIBILITÉ DE PERSONNALISATION  
BESPOKE OPTIONS AVAILABLE



ÉGALEMENT DISPONIBLE EN MÉTAL ARGENTÉ SUR DEMANDE  
ALSO AVAILABLE IN SILVERPLATED FINISH ON DEMAND





# NEULLY

MADE IN FRANCE



**105278**  
**FOURCHETTE DE TABLE**  
TABLE FORK  
L 207 mm L 8 in<sup>1/8</sup>



**105274**  
**COUTEAU DE TABLE MANCHE**  
**ORFÈVRE LAME SCIE**  
TABLE KNIFE, HOLLOW  
HANDLE, SERRATED  
L 247 mm L 9 in<sup>3/4</sup>



**105310**  
**CUILLÈRE DE TABLE**  
TABLE / PASTA SPOON  
L 207 mm L 8 in<sup>1/8</sup>



**105294**  
**CUILLÈRE À DESSERT**  
SOUP / DESSERT SPOON, OVAL  
L 177 mm L 6 in<sup>15/16</sup>



**105290**  
**FOURCHETTE À DESSERT**  
SALAD / DESSERT FORK  
L 177 mm L 6 in<sup>15/16</sup>



**105305**  
**COUTEAU À DESSERT MANCHE**  
**ORFÈVRE LAME UNIE**  
DESSERT KNIFE, HOLLOW  
HANDLE  
L 206 mm L 8 in<sup>1/8</sup>



**105303**  
**CUILLÈRE À CAFÉ**  
COFFEE / TEASPOON  
L 139 mm L 5 in<sup>1/2</sup>



**105293**  
**CUILLÈRE À MOKA**  
DEMITASSE / ESPRESSO SPOON  
L 110 mm L 4 in<sup>5/16</sup>

## SUGGESTION PIÈCES COMPLÉMENTAIRES SUGGESTED ADDITIONAL PIECES VERLAINE



**002185**  
**FOURCHETTE DE SERVICE**  
SERVING FORK  
L 248 mm L 9 in<sup>3/4</sup>



**002186**  
**CUILLÈRE DE SERVICE**  
SERVING SPOON  
L 250 mm L 9 in<sup>13/16</sup>



**040646**  
**COUVERTS À SALADE**  
SALAD SERVING SET, 2 PCS  
L 257 mm L 10 in<sup>1/8</sup>



**083340**  
**PELLE À TARTE**  
PASTRY SERVER, SOLID  
HANDLE  
L 251 mm L 9 in<sup>7/8</sup>



**097717**  
**LOUCHE**  
SOUP LADLE  
L 305 mm L 12 in



**002179**  
**LOUCHE À SAUCE**  
SAUCE LADLE  
L 156 mm L 6 in<sup>1/8</sup>



18-10



3,5

POSSIBILITÉ DE PERSONNALISATION  
BESPOKE OPTIONS AVAILABLE



ÉGALEMENT DISPONIBLE EN MÉTAL ARGENTÉ SUR DEMANDE  
ALSO AVAILABLE IN SILVERPLATED FINISH ON DEMAND



# NORMANDY



**232963**  
**FOURCHETTE DE TABLE**  
TABLE FORK  
L 203 mm L 8 in



**234656**  
**FOURCHETTE À DESSERT / POISSON**  
SALAD / DESSERT / FISH FORK  
L 183 mm L 7 in<sup>3/16</sup>



**232966**  
**COUTEAU DE TABLE MONOBLOC LAME SCIE**  
TABLE KNIFE, 1 PC SOLID HANDLE, SERRATED  
L 240 mm L 9 in<sup>7/16</sup>



**239036**  
**COUTEAU À POISSON GOURMET**  
FISH / GOURMET KNIFE  
L 205 mm L 8 in<sup>1/16</sup>



**232964**  
**CUILLÈRE DE TABLE**  
TABLE / PASTA SPOON  
L 203 mm L 8 in



**234655**  
**CUILLÈRE À SAUCE GOURMET**  
GOURMET SAUCE SPOON, FLAT  
L 182 mm L 7 in<sup>3/16</sup>



**234654**  
**CUILLÈRE À SOUPE ANGLAISE**  
BOUILLON SPOON, ROUND  
L 177 mm L 6 in<sup>5/16</sup>



**232965**  
**CUILLÈRE À CAFÉ**  
COFFEE / TEASPOON  
L 140 mm L 5 in<sup>1/2</sup>



**234659**  
**CUILLÈRE À DESSERT**  
SOUP / DESSERT SPOON, OVAL  
L 182 mm L 7 in<sup>3/16</sup>



**234660**  
**CUILLÈRE À MOKA**  
DEMITASSE / ESPRESSO SPOON  
L 111 mm L 4 in<sup>3/8</sup>



**234656**  
**FOURCHETTE À DESSERT / POISSON**  
SALAD / DESSERT / FISH FORK  
L 183 mm L 7 in<sup>3/16</sup>



**234661**  
**FOURCHETTE À GÂTEAUX**  
COCKTAIL / PASTRY FORK  
L 140 mm L 5 in<sup>1/2</sup>



**234657**  
**COUTEAU À DESSERT MONOBLOC LAME UNIE**  
DESSERT KNIFE, 1 PC SOLID HANDLE  
L 216 mm L 8 in<sup>1/2</sup>



**236525**  
**FOURCHETTE DE SERVICE**  
SERVING FORK  
L 261 mm L 10 in<sup>1/4</sup>



**234658**  
**COUTEAU À BEURRE MONOBLOC LAME UNIE**  
BUTTER KNIFE, 1 PC SOLID HANDLE  
L 185 mm L 7 in<sup>5/16</sup>



**236526**  
**CUILLÈRE DE SERVICE**  
SERVING SPOON  
L 260 mm L 10 in<sup>1/4</sup>



18-10



3,5

POSSIBILITÉ DE PERSONNALISATION  
BESPOKE OPTIONS AVAILABLE



ÉGALEMENT DISPONIBLE EN MÉTAL ARGENTÉ SUR DEMANDE  
ALSO AVAILABLE IN SILVERPLATED FINISH ON DEMAND



# SWELL

MADE IN FRANCE



**204524**  
**FOURCHETTE DE TABLE**  
TABLE FORK  
L 203 mm L 8 in



**246567**  
**COUTEAU DE TABLE MONOBLOC LAME SCIE**  
TABLE KNIFE, 1 PC SOLID HANDLE, SERRATED  
L 244 mm L 9 in<sup>5/8</sup>



**204523**  
**CUILLÈRE DE TABLE**  
TABLE / PASTA SPOON  
L 203 mm L 8 in



**209268**  
**CUILLÈRE À DESSERT**  
SOUP / DESSERT SPOON, OVAL  
L 179 mm L 7 in<sup>1/16</sup>



**209267**  
**FOURCHETTE À DESSERT**  
SALAD / DESSERT FORK  
L 178 mm L 7 in



**246568**  
**COUTEAU À DESSERT MONOBLOC LAME UNIE**  
DESSERT KNIFE, 1 PC SOLID HANDLE  
L 210 mm L 8 in<sup>1/4</sup>



**204525**  
**CUILLÈRE À CAFÉ**  
COFFEE / TEASPOON  
L 135 mm L 5 in<sup>5/16</sup>



18-10



POSSIBILITÉ DE PERSONNALISATION  
BESPOKE OPTIONS AVAILABLE



ÉGALEMENT DISPONIBLE EN MÉTAL ARGENTÉ SUR DEMANDE  
ALSO AVAILABLE IN SILVERPLATED FINISH ON DEMAND



# VERLAINE

MADE IN FRANCE



**105831\***  
FOURCHETTE DE TABLE  
TABLE FORK  
L 207 mm L 8 in<sup>5/8</sup>



**105861\***  
CUILLÈRE À DESSERT  
SOUP / DESSERT SPOON, OVAL  
L 177 mm L 6 in<sup>15/16</sup>



**182460**  
COUTEAU DE TABLE  
MONOBLOC LAME SCIE  
TABLE KNIFE, 1 PC SOLID  
HANDLE, SERRATED  
L 244 mm L 9 in<sup>5/8</sup>



**105885\***  
FOURCHETTE À DESSERT  
SALAD / DESSERT FORK  
L 177 mm L 6 in<sup>15/16</sup>



**105860\***  
COUTEAU DE TABLE MANCHE  
ORFÈVRE LAME SCIE  
TABLE KNIFE, HOLLOW HANDLE,  
SERRATED  
L 247 mm L 9 in<sup>3/4</sup>



**182463**  
COUTEAU À DESSERT  
MONOBLOC LAME UNIE  
DESSERT KNIFE, 1 PC SOLID  
HANDLE  
L 211 mm L 8 in<sup>5/16</sup>



**105886**  
COUTEAU DE TABLE MANCHE  
ORFÈVRE LAME UNIE  
TABLE KNIFE, HOLLOW HANDLE  
L 247 mm L 9 in<sup>3/4</sup>



**105832\***  
COUTEAU À DESSERT MANCHE  
ORFÈVRE LAME UNIE  
DESSERT KNIFE, HOLLOW  
HANDLE  
L 206 mm L 8 in<sup>1/8</sup>



**105801**  
COUTEAU À STEAK MANCHE  
ORFÈVRE LAME SCIE  
STEAK KNIFE, HOLLOW  
HANDLE, SERRATED  
L 238 mm L 9 in<sup>3/8</sup>



**190420**  
COUTEAU À BEURRE  
MONOBLOC LAME UNIE  
BUTTER KNIFE, 1 PC SOLID  
HANDLE  
L 190 mm L 7 in<sup>1/2</sup>



**105798\***  
CUILLÈRE DE TABLE  
TABLE / PASTA SPOON  
L 207 mm L 8 in<sup>1/8</sup>



**003332**  
COUTEAU À BEURRE MANCHE  
ORFÈVRE  
BUTTER KNIFE, HOLLOW  
HANDLE  
L 187 mm L 7 in<sup>3/8</sup>



**105908**  
CUILLÈRE À SOUPE ANGLAISE  
BOUILLON SPOON, ROUND  
L 173 mm L 6 in<sup>13/16</sup>



18-10



3,5

POSSIBILITÉ DE PERSONNALISATION  
BESPOKE OPTIONS AVAILABLE



ÉGALEMENT DISPONIBLE EN MÉTAL ARGENTÉ SUR STOCK\*  
ALSO AVAILABLE IN SILVERPLATED FINISH ON STOCK

SUITE PAGE 47  
FOLLOWING PAGE 47





# VERLAINE

MADE IN FRANCE



**105888**  
**FOURCHETTE À POISSON**  
FISH FORK, 3 TINE  
L 177 mm L 6 in<sup>15/16</sup>



**105797**  
**COUTEAU À POISSON**  
FISH KNIFE  
L 199 mm L 7 in<sup>13/16</sup>



**105910**  
**CUILLÈRE À SAUCE GOURMET**  
GOURMET SAUCE SPOON, FLAT  
L 179 mm L 7 in<sup>1/16</sup>



**105833\***  
**CUILLÈRE À CAFÉ**  
COFFEE / TEASPOON  
L 139 mm L 5 in<sup>1/2</sup>



**105906\***  
**CUILLÈRE À MOKA**  
DEMITASSE / ESPRESSO SPOON  
L 110 mm L 4 in<sup>5/16</sup>



**105800**  
**CUILLÈRE À SODA**  
ICED TEASPOON / LONGDRINK  
L 179 mm L 7 in<sup>1/16</sup>



**105795**  
**FOURCHETTE À GÂTEAUX**  
COCKTAIL / PASTRY FORK  
L 138 mm L 5 in<sup>7/16</sup>



**105907**  
**FOURCHETTE À HÙÎTRES**  
OYSTER / SHELLFISH FORK  
L 130 mm L 5 in<sup>1/8</sup>



**132782**  
**FOURCHETTE À ESCARGOTS**  
CONFIDENCE  
SNAIL FORK, 2 TINE  
L 135 mm L 5 in<sup>5/16</sup>



**003390**  
**COUTEAU À FROMAGE MANCHE**  
ORFÈVRE LAME UNIE  
CHEESE KNIFE, HOLLOW  
HANDLE, HOOKED  
L 194 mm L 7 in<sup>5/8</sup>



**002185**  
**FOURCHETTE DE SERVICE**  
SERVING FORK  
L 248 mm L 9 in<sup>3/4</sup>



**002186**  
**CUILLÈRE DE SERVICE**  
SERVING SPOON  
L 250 mm L 9 in<sup>13/16</sup>



**040646**  
**COUVERTS À SALADE**  
SALAD SERVING SET, 2 PCS  
L 257 mm L 10 in<sup>1/8</sup>



**083340**  
**PELLE À TARTE**  
PASTRY SERVER, SOLID  
HANDLE  
L 251 mm L 9 in<sup>7/8</sup>



**097717**  
**LOUCHE**  
SOUP LADLE  
L 305 mm L 12 in



**002179**  
**LOUCHE À SAUCE**  
SAUCE LADLE  
L 156 mm L 6 in<sup>1/8</sup>



18-10



3,5

POSSIBILITÉ DE PERSONNALISATION  
BESPOKE OPTIONS AVAILABLE



ÉGALEMENT DISPONIBLE EN MÉTAL ARGENTÉ SUR STOCK\*  
ALSO AVAILABLE IN SILVERPLATED FINISH ON STOCK



# VIEUX PARIS SATINÉ



**105804**  
FOURCHETTE DE TABLE  
TABLE FORK  
L 206 mm L 8 in<sup>1/8</sup>



**105892**  
COUTEAU DE TABLE  
MONOBLOC LAME SCIE  
TABLE KNIFE, 1 PC SOLID  
HANDLE, SERRATED  
L 237 mm L 9 in<sup>3/16</sup>



**160424**  
COUTEAU À STEAK MONOBLOC  
LAME SCIE  
STEAK KNIFE, 1 PC SOLID  
HANDLE, SERRATED  
L 233 mm L 9 in<sup>3/16</sup>



**105911**  
CUILLÈRE DE TABLE  
TABLE / PASTA SPOON  
L 209 mm L 8 in<sup>1/4</sup>



**105863**  
CUILLÈRE À DESSERT  
SOUP / DESSERT SPOON, OVAL  
L 178 mm L 7 in



**105890**  
FOURCHETTE À DESSERT  
SALAD / DESSERT FORK  
L 178 mm L 7 in



**210626**  
COUTEAU À DESSERT  
MONOBLOC LAME SCIE  
DESSERT KNIFE SOLID HANDLE  
SERRATED  
L 205 mm L 8 in<sup>1/16</sup>



**105837**  
FOURCHETTE À POISSON  
FISH FORK, 3 TINE  
L 178 mm L 7 in



**105912**  
COUTEAU À POISSON  
FISH KNIFE  
L 196 mm L 7 in<sup>11/16</sup>



**105838**  
CUILLÈRE À CAFÉ  
COFFEE / TEASPOON  
L 140 mm L 5 in<sup>1/2</sup>



**105891**  
CUILLÈRE À MOKA  
DEMITASSE / ESPRESSO  
SPOON  
L 108 mm L 4 in<sup>1/4</sup>



**105805**  
FOURCHETTE À GÂTEAUX  
COCKTAIL / PASTRY FORK  
L 138 mm L 5 in<sup>7/16</sup>



**105803**  
FOURCHETTE À HÙITRES  
OYSTER / SHELLFISH FORK  
L 131 mm L 5 in<sup>3/16</sup>



**000490**  
FOURCHETTE DE SERVICE  
SERVING FORK  
L 249 mm L 9 in<sup>13/16</sup>



**000491**  
CUILLÈRE DE SERVICE  
SERVING SPOON  
L 247 mm L 9 in<sup>3/4</sup>



LES COUVERTS DESIGN  
DESIGN FLATWARE

AQUATIC . . . . .	53
ASTRÉE CISELÉ . . . . .	55
COUTURE . . . . .	57
FUSE . . . . .	59
FUSE MARTELÉ . . . . .	61
FUSE MARTELÉ LAITON . . . . .	63
GUEST . . . . .	65
GUEST CUIVRE . . . . .	67
GUEST STAR . . . . .	69
GUEST VINTAGE . . . . .	71
L'É STARCK . . . . .	73
NORWAY . . . . .	75
ONDE . . . . .	77
ONDE GOLD . . . . .	79
OVATION . . . . .	81
RIVAGE . . . . .	83
SOLSTICE . . . . .	85
SUPERNATURE . . . . .	87
XY . . . . .	89
XY BLACK . . . . .	91



# AQUATIC

MADE IN FRANCE



**126355**  
**FOURCHETTE DE TABLE**  
TABLE FORK  
L 201 mm L 7 in<sup>15/16</sup>



**126358**  
**CUILLÈRE À CAFÉ**  
COFFEE / TEASPOON  
L 138 mm L 5 in<sup>7/16</sup>



**210731**  
**COUTEAU DE TABLE**  
**MONOBLOC LAME SCIE**  
TABLE KNIFE, 1 PC SOLID  
HANDLE, SERRATED  
L 235 mm L 9 in<sup>1/4</sup>



**140852**  
**CUILLÈRE À MOKA**  
DEMITASSE / ESPRESSO SPOON  
L 112 mm L 4 in<sup>7/16</sup>



**126352**  
**CUILLÈRE DE TABLE**  
TABLE / PASTA SPOON  
L 203 mm L 8 in



**189973**  
**TYPE GOUTTE**  
**CUILLÈRE À SODA**  
ICED TEASPOON / LONGDRINK  
L 190 mm L 7 in<sup>1/2</sup>



**140855**  
**CUILLÈRE À SOUPE ANGLAISE**  
BOUILLON SPOON, ROUND  
L 179 mm L 7 in<sup>1/16</sup>



**126383**  
**FOURCHETTE À GÂTEAUX**  
COCKTAIL / PASTRY FORK  
L 138 mm L 5 in<sup>7/16</sup>



**126368**  
**CUILLÈRE À DESSERT**  
SOUP / DESSERT SPOON, OVAL  
L 178 mm L 7 in



**189974**  
**TYPE GOUTTE**  
**FOURCHETTE À HÛÎTRES**  
OYSTER / SHELLFISH FORK  
L 141 mm L 5 in<sup>7/16</sup>



**126371**  
**FOURCHETTE À DESSERT**  
SALAD / DESSERT FORK  
L 177 mm L 6 in<sup>15/16</sup>

## SUGGESTION PIÈCES COMPLÉMENTAIRES SUGGESTED ADDITIONAL PIECES TYPE GOUTTE



**210732**  
**COUTEAU À DESSERT**  
**MONOBLOC LAME UNIE**  
DESSERT KNIFE, 1 PC SOLID  
HANDLE  
L 207 mm L 8 in<sup>1/8</sup>



**231218**  
**FOURCHETTE DE SERVICE**  
COCKTAIL / PASTRY FORK  
L 266 mm L 10 in<sup>1/2</sup>



**189971**  
**TYPE GOUTTE**  
**COUTEAU À BEURRE**  
**MONOBLOC LAME UNIE**  
BUTTER KNIFE, 1 PC SOLID  
HANDLE  
L 189 mm L 7 in<sup>7/16</sup>



**231219**  
**CUILLÈRE DE SERVICE**  
SERVING SPOON  
L 266 mm L 10 in<sup>1/2</sup>



**126377**  
**FOURCHETTE À POISSON**  
FISH FORK, 3 TINE  
L 177 mm L 6 in<sup>15/16</sup>



**231221**  
**PELLE À TARTE**  
PASTRY SERVER, SOLID  
HANDLE  
L 252 mm L 9 in<sup>15/16</sup>



**181181**  
**COUTEAU À POISSON GOURMET**  
FISH / GOURMET KNIFE  
L 200 mm L 7 in<sup>7/8</sup>



**231220**  
**LOUCHE**  
SOUP LADLE  
L 290 mm L 11 in<sup>7/16</sup>



18-10



POSSIBILITÉ DE PERSONNALISATION  
BESPOKE OPTIONS AVAILABLE



ÉGALEMENT DISPONIBLE EN MÉTAL ARGENTÉ SUR DEMANDE  
ALSO AVAILABLE IN SILVERPLATED FINISH ON DEMAND





# ASTRÉE CISELÉ



**153998**  
**FOURCHETTE DE TABLE**  
TABLE FORK  
L 207 mm L 8 in<sup>1/8</sup>



**154002**  
**COUTEAU DE TABLE**  
**MONOBLOC LAME SCIE**  
TABLE KNIFE, 1 PC SOLID  
HANDLE, SERRATED  
L 235 mm L 9 in<sup>1/4</sup>



**199761**  
**COUTEAU À STEAK MONOBLOC**  
**LAME SCIE**  
STEAK KNIFE, 1 PC SOLID  
HANDLE, SERRATED  
L 228 mm L 9 in



**153996**  
**CUILLÈRE DE TABLE**  
TABLE / PASTA SPOON  
L 207 mm L 8 in<sup>1/8</sup>



**190015**  
**CUILLÈRE À SOUPE ANGLAISE**  
BOUILLON SPOON, ROUND  
L 185 mm L 7 in<sup>5/16</sup>



**154571**  
**CUILLÈRE À DESSERT**  
SOUP / DESSERT SPOON, OVAL  
L 186 mm L 7 in<sup>5/16</sup>



**154574**  
**FOURCHETTE À DESSERT**  
SALAD / DESSERT FORK  
L 186 mm L 7 in<sup>5/16</sup>



**154555**  
**COUTEAU À DESSERT**  
**MONOBLOC LAME SCIE**  
DESSERT KNIFE, 1 PC SOLID  
HANDLE, SERRATED  
L 211 mm L 8 in<sup>5/16</sup>



**154580**  
**COUTEAU À BEURRE**  
**MONOBLOC LAME UNIE**  
BUTTER KNIFE, 1 PC SOLID  
HANDLE  
L 198 mm L 7 in<sup>13/16</sup>



**154558**  
**FOURCHETTE À POISSON**  
FISH FORK, 3 TINE  
L 186 mm L 7 in<sup>5/16</sup>



**154561**  
**COUTEAU À POISSON**  
FISH KNIFE  
L 211 mm L 8 in<sup>5/16</sup>



**154001**  
**CUILLÈRE À CAFÉ**  
COFFEE / TEASPOON  
L 141 mm L 5 in<sup>7/16</sup>



**154577**  
**CUILLÈRE À MOKA**  
DEMITASSE / ESPRESSO  
SPOON  
L 111 mm L 4 in<sup>3/8</sup>



**190016**  
**CUILLÈRE À SODA**  
ICED TEASPOON / LONGDRINK  
L 190 mm L 7 in<sup>1/2</sup>



**154547**  
**FOURCHETTE À GÂTEAUX**  
COCKTAIL / PASTRY FORK  
L 140 mm L 5 in<sup>1/2</sup>



**154563**  
**FOURCHETTE DE SERVICE**  
SERVING FORK  
L 251 mm L 9 in<sup>7/8</sup>



**154562**  
**CUILLÈRE DE SERVICE**  
SERVING SPOON  
L 255 mm L 10 in<sup>1/16</sup>



**154566**  
**COUVERTS À SALADE**  
SALAD SERVING SET, 2 PCS  
L 243 mm L 9 in<sup>9/16</sup>



**154552**  
**PELLE À TARTE**  
PASTRY SERVER, SOLID  
HANDLE  
L 253 mm L 9 in<sup>15/16</sup>



**154550**  
**LOUCHE**  
SOUP LADLE  
L 297 mm L 11 in<sup>11/16</sup>



# COUTURE

MADE IN FRANCE



**239410**  
**FOURCHETTE DE TABLE**  
TABLE FORK  
L 201 mm L 7 in<sup>15/16</sup>



**239411**  
**COUTEAU DE TABLE MANCHE ORFÈVRE LAME UNIE**  
TABLE KNIFE, HOLLOW HANDLE  
L 235 mm L 9 in<sup>1/4</sup>



**239412**  
**CUILLÈRE DE TABLE**  
TABLE / PASTA SPOON  
L 203 mm L 8 in



**247971** **NEW**  
**CUILLÈRE À SOUPE ANGLAISE**  
BOUILLON SPOON, ROUND  
L 178 mm L 7 in



**239416**  
**CUILLÈRE À DESSERT**  
SOUP / DESSERT SPOON, OVAL  
L 178 mm L 7 in



**239414**  
**FOURCHETTE À DESSERT**  
SALAD / DESSERT FORK  
L 177 mm L 6 in<sup>15/16</sup>



**239415**  
**COUTEAU À DESSERT MANCHE ORFÈVRE LAME UNIE**  
DESSERT KNIFE, HOLLOW HANDLE  
L 212 mm L 8 in<sup>3/8</sup>



**247969** **NEW**  
**COUTEAU À BEURRE MANCHE ORFÈVRE**  
BUTTER KNIFE, HOLLOW HANDLE  
L 181 mm L 7 in<sup>1/8</sup>



**239418**  
**FOURCHETTE À POISSON**  
FISH FORK, 3 TINE  
L 177 mm L 6 in<sup>15/16</sup>



**239419**  
**COUTEAU À POISSON GOURMET**  
FISH / GOURMET KNIFE  
L 200 mm L 7 in<sup>7/8</sup>



**239413**  
**CUILLÈRE À CAFÉ**  
COFFEE / TEASPOON  
L 138 mm L 5 in<sup>7/16</sup>



**239417**  
**CUILLÈRE À MOKA**  
DEMITASSE / ESPRESSO SPOON  
L 112 mm L 4 in<sup>7/16</sup>



ÉGALEMENT DISPONIBLE EN MÉTAL ARGENTÉ SUR DEMANDE  
ALSO AVAILABLE IN SILVERPLATED FINISH ON DEMAND



# FUSE



**236700**  
**FOURCHETTE DE TABLE**  
TABLE FORK  
L 215 mm L 8 in<sup>7/16</sup>



**236702**  
**COUTEAU DE TABLE**  
**MONOBLOC LAME SCIE**  
TABLE KNIFE, 1 PC SOLID  
HANDLE, SERRATED  
L 215 mm L 8 in<sup>7/16</sup>



**111970**  
**COUTEAU DE TABLE OVATION**  
**MONOBLOC LAME SCIE**  
TABLE KNIFE, 1 PC SOLID  
HANDLE, SERRATED  
L 230 mm L 9 in<sup>1/16</sup>



**236701**  
**CUILLÈRE DE TABLE**  
TABLE / PASTA SPOON  
L 215 mm L 8 in<sup>7/16</sup>



**236726**  
**CUILLÈRE À SOUPE ANGLAISE**  
BOUILLON SPOON, ROUND  
L 185 mm L 7 in<sup>5/16</sup>



**236721**  
**CUILLÈRE À DESSERT**  
SOUP / DESSERT SPOON, OVAL  
L 192 mm L 7 in<sup>9/16</sup>



**236719**  
**FOURCHETTE À DESSERT**  
SALAD / DESSERT FORK  
L 192 mm L 7 in<sup>9/16</sup>



**236720**  
**COUTEAU À DESSERT**  
**MONOBLOC LAME UNIE**  
DESSERT KNIFE, 1 PC SOLID  
HANDLE  
L 192 mm L 7 in<sup>9/16</sup>



**236727**  
**TARTINEUR MONOBLOC LAME**  
**UNIE**  
BUTTER KNIFE, 1 PC SOLID  
HANDLE  
L 165 mm L 6 in<sup>1/2</sup>



**181112**  
**TARTINEUR MONOBLOC LAME**  
**UNIE XY**  
BUTTER KNIFE, 1 PC SOLID  
HANDLE  
L 160 mm L 6 in<sup>5/16</sup>



**236703**  
**CUILLÈRE À CAFÉ**  
COFFEE / TEASPOON  
L 150 mm L 5 in<sup>7/8</sup>



**236722**  
**CUILLÈRE À MOKA**  
DEMITASSE / ESPRESSO SPOON  
L 110 mm L 4 in<sup>5/16</sup>



**236724**  
**FOURCHETTE DE SERVICE**  
SERVING FORK  
L 260 mm L 10 in<sup>1/4</sup>



**236723**  
**CUILLÈRE DE SERVICE**  
SERVING SPOON  
L 260 mm L 10 in<sup>1/4</sup>



**237181**  
**COUVERTS À SALADE**  
SALAD SERVING SET, 2 PCS  
L 260 mm L 10 in<sup>1/4</sup>



18-10



POSSIBILITÉ DE PERSONNALISATION  
BESPOKE OPTIONS AVAILABLE



ÉGALEMENT DISPONIBLE EN MÉTAL ARGENTÉ SUR DEMANDE  
ALSO AVAILABLE IN SILVERPLATED FINISH ON DEMAND



# FUSE MARTELÉ



**236790**  
**FOURCHETTE DE TABLE**  
TABLE FORK  
L 215 mm L 8 in<sup>7/16</sup>



**236791**  
**COUTEAU DE TABLE**  
**MONOBLOC LAME SCIE**  
TABLE KNIFE, 1 PC SOLID  
HANDLE, SERRATED  
L 215 mm L 8 in<sup>7/16</sup>



**236789**  
**CUILLÈRE DE TABLE**  
TABLE / PASTA SPOON  
L 215 mm L 8 in<sup>7/16</sup>



**236802**  
**CUILLÈRE À SOUPE ANGLAISE**  
BOUILLON SPOON, ROUND  
L 185 mm L 7 in<sup>5/16</sup>



**236796**  
**CUILLÈRE À DESSERT**  
SOUP / DESSERT SPOON, OVAL  
L 192 mm L 7 in<sup>9/16</sup>



**236794**  
**FOURCHETTE À DESSERT**  
SALAD / DESSERT FORK  
L 192 mm L 7 in<sup>9/16</sup>



**236795**  
**COUTEAU À DESSERT**  
**MONOBLOC LAME UNIE**  
DESSERT KNIFE, 1 PC SOLID  
HANDLE  
L 192 mm L 7 in<sup>9/16</sup>



**236804**  
**TARTINEUR MONOBLOC LAME**  
**UNIE**  
BUTTER KNIFE, 1 PC SOLID  
HANDLE  
L 165 mm L 6 in<sup>1/2</sup>



**236798**  
**CUILLÈRE À CAFÉ**  
COFFEE / TEASPOON  
L 150 mm L 5 in<sup>7/8</sup>



**236797**  
**CUILLÈRE À MOKA**  
DEMITASSE / ESPRESSO SPOON  
L 110 mm L 4 in<sup>5/16</sup>



**236805**  
**FOURCHETTE À GÂTEAUX**  
COCKTAIL / PASTRY FORK  
L 150 mm L 5 in<sup>7/8</sup>



**236806**  
**PIQUE APÉRITIF**  
APPETIZER FORK  
L 150 mm L 5 in<sup>7/8</sup>



**236800**  
**FOURCHETTE DE SERVICE**  
SERVING FORK  
L 260 mm L 10 in<sup>1/4</sup>



**236799**  
**CUILLÈRE DE SERVICE**  
SERVING SPOON  
L 260 mm L 10 in<sup>1/4</sup>



**236807**  
**COUVERTS À SALADE**  
SALAD SERVING SET, 2 PCS  
L 260 mm L 10 in<sup>1/4</sup>



18-10



POSSIBILITÉ DE PERSONNALISATION  
BESPOKE OPTIONS AVAILABLE





# FUSE MARTELÉ LAITON



**237162**  
**FOURCHETTE DE TABLE**  
TABLE FORK  
L 215 mm L 8 in<sup>7/16</sup>



**237166**  
**COUTEAU DE TABLE MONOBLOC LAME SCIE**  
TABLE KNIFE, 1 PC SOLID HANDLE, SERRATED  
L 215 mm L 8 in<sup>7/16</sup>



**237163**  
**CUILLÈRE DE TABLE**  
TABLE / PASTA SPOON  
L 215 mm L 8 in<sup>7/16</sup>



**237169**  
**CUILLÈRE À CAFÉ**  
COFFEE / TEASPOON  
L 150 mm L 5 in<sup>7/8</sup>



**239054**  
**COUVERTS À SALADE**  
SALAD SERVING SET, 2 PCS  
L 260 mm L 10 in<sup>1/4</sup>



# GUEST



**197507**  
**FOURCHETTE DE TABLE**  
TABLE FORK  
L 213 mm L 8 in<sup>3/8</sup>



**197509**  
**COUTEAU DE TABLE**  
**MONOBLOC LAME SCIE**  
TABLE KNIFE, 1 PC SOLID  
HANDLE, SERRATED  
L 232 mm L 9 in<sup>1/8</sup>



**235481**  
**COUTEAU DE TABLE**  
**MONOBLOC LAME SCIE BOUT**  
**ROND**  
TABLE KNIFE, 1 PC SOLID  
HANDLE, SERRATED, ROUND  
BLADE  
L 237 mm L 9 in<sup>5/16</sup>



**197521**  
**COUTEAU À STEAK MONOBLOC**  
**LAME SCIE**  
STEAK KNIFE, 1 PC SOLID  
HANDLE, SERRATED  
L 232 mm L 9 in<sup>1/8</sup>



**197506**  
**CUILLÈRE DE TABLE**  
TABLE / PASTA SPOON  
L 216 mm L 8 in<sup>1/2</sup>



**197518**  
**CUILLÈRE À SOUPE ANGLAISE**  
BOUILLON SPOON, ROUND  
L 185 mm L 7 in<sup>5/16</sup>



**197512**  
**CUILLÈRE À DESSERT**  
SOUP / DESSERT SPOON, OVAL  
L 195 mm L 7 in<sup>11/16</sup>



**197511**  
**FOURCHETTE À DESSERT**  
SALAD / DESSERT FORK  
L 192 mm L 7 in<sup>7/16</sup>



**210629**  
**COUTEAU À DESSERT**  
**MONOBLOC LAME SCIE**  
DESSERT KNIFE SOLID HANDLE  
SERRATED  
L 209 mm L 8 in<sup>1/4</sup>



**235482**  
**COUTEAU À DESSERT**  
**MONOBLOC LAME UNIE BOUT**  
**ROND**  
DESSERT KNIFE, 1 PC SOLID  
HANDLE, ROUND BLADE  
L 213 mm L 8 in<sup>3/8</sup>



**197520**  
**COUTEAU À BEURRE**  
**MONOBLOC LAME UNIE**  
BUTTER KNIFE, 1 PC SOLID  
HANDLE  
L 193 mm L 7 in<sup>5/8</sup>



**181112**  
**TARTINEUR MONOBLOC LAME**  
**UNIE XY**  
BUTTER KNIFE, 1 PC SOLID  
HANDLE  
L 160 mm L 6 in<sup>5/16</sup>



**197514**  
**FOURCHETTE À POISSON**  
FISH FORK, 3 TINE  
L 192 mm L 7 in<sup>9/16</sup>



**197515**  
**COUTEAU À POISSON**  
**GOURMET**  
FISH / GOURMET KNIFE  
L 213 mm L 8 in<sup>3/8</sup>



**197508**  
**CUILLÈRE À CAFÉ**  
COFFEE / TEASPOON  
L 143 mm L 5 in<sup>5/8</sup>



**197510**  
**CUILLÈRE À MOKA**  
DEMITASSE / ESPRESSO  
SPOON  
L 117 mm L 4 in<sup>5/8</sup>



**190018**  
**CUILLÈRE À SODA TYPE DROIT**  
ICED TEASPOON / LONGDRINK  
L 189 mm L 7 in<sup>1/16</sup>



**197516**  
**FOURCHETTE À GÂTEAUX**  
COCKTAIL / PASTRY FORK  
L 139 mm L 5 in<sup>1/2</sup>



**190424**  
**FOURCHETTE À HÛTRES**  
**TYPE DROIT**  
OYSTER / SHELLFISH FORK  
L 141 mm L 5 in<sup>9/16</sup>



**197522**  
**FOURCHETTE DE SERVICE**  
SERVING FORK  
L 266 mm L 10 in<sup>1/2</sup>



**197523**  
**CUILLÈRE DE SERVICE**  
SERVING SPOON  
L 270 mm L 10 in<sup>5/8</sup>



**197525**  
**COUVERTS À SALADE**  
SALAD SERVING SET, 2 PCS  
L 300 mm L 11 in<sup>13/16</sup>



**197527**  
**PELLE À TARTE**  
PASTRY SERVER, SOLID  
HANDLE  
L 251 mm L 9 in<sup>7/8</sup>



**153193**  
**LOUCHE TYPE DROIT**  
SOUP LADLE  
L 297 mm L 11 in<sup>11/16</sup>



**154606**  
**LOUCHE À SAUCE TYPE DROIT**  
SAUCE LADLE  
L 185 mm L 7 in<sup>5/16</sup>



POSSIBILITÉ DE PERSONNALISATION  
BESPOKE OPTIONS AVAILABLE



ÉGALEMENT DISPONIBLE EN MÉTAL ARGENTÉ SUR DEMANDE  
ALSO AVAILABLE IN SILVERPLATED FINISH ON DEMAND



# GUEST CUIVRE



**230848**  
**FOURCHETTE DE TABLE**  
TABLE FORK  
L 213 mm    L 8 in<sup>3/8</sup>



**230850**  
**COUTEAU DE TABLE MONOBLOC LAME SCIE**  
TABLE KNIFE, 1 PC SOLID HANDLE, SERRATED  
L 232 mm    L 9 in<sup>1/8</sup>



**230849**  
**CUILLÈRE DE TABLE**  
TABLE / PASTA SPOON  
L 216 mm    L 8 in<sup>1/2</sup>



**230854**  
**CUILLÈRE À DESSERT**  
SOUP / DESSERT SPOON, OVAL  
L 195 mm    L 7 in<sup>11/16</sup>



**230853**  
**FOURCHETTE À DESSERT**  
SALAD / DESSERT FORK  
L 192 mm    L 7 in<sup>9/16</sup>



**230855**  
**COUTEAU À DESSERT MONOBLOC LAME SCIE**  
DESSERT KNIFE, 1 PC SOLID HANDLE, SERRATED  
L 209 mm    L 8 in<sup>1/4</sup>



**230851**  
**CUILLÈRE À CAFÉ**  
COFFEE / TEASPOON  
L 143 mm    L 5 in<sup>5/8</sup>



**230852**  
**CUILLÈRE À MOKA**  
DEMITASSE / ESPRESSO SPOON  
L 117 mm    L 4 in<sup>5/8</sup>



PVD

18-10



POSSIBILITÉ DE PERSONNALISATION  
BESPOKE OPTIONS AVAILABLE



# GUEST STAR



**223482**  
**FOURCHETTE DE TABLE**  
TABLE FORK  
L 213 mm L 8 in<sup>3/8</sup>



**223487**  
**FOURCHETTE À POISSON**  
FISH FORK, 3 TINE  
L 192 mm L 7 in<sup>9/16</sup>



**202995**  
**COUTEAU DE TABLE**  
**MONOBLOC LAME SCIE**  
TABLE KNIFE, 1 PC SOLID  
HANDLE, SERRATED  
L 232 mm L 9 in<sup>1/8</sup>



**223488**  
**COUTEAU À POISSON**  
**GOURMET**  
FISH / GOURMET KNIFE  
L 213 mm L 8 in<sup>3/8</sup>



**203017**  
**COUTEAU À STEAK MONOBLOC**  
**LAME SCIE**  
STEAK KNIFE, 1 PC SOLID  
HANDLE, SERRATED  
L 232 mm L 9 in<sup>1/8</sup>



**223483**  
**CUILLÈRE À CAFÉ**  
COFFEE / TEASPOON  
L 143 mm L 5 in<sup>5/8</sup>



**223481**  
**CUILLÈRE DE TABLE**  
TABLE / PASTA SPOON  
L 216 mm L 8 in<sup>1/2</sup>



**223484**  
**CUILLÈRE À MOKA**  
DEMITASSE / ESPRESSO  
SPOON  
L 117 mm L 4 in<sup>5/8</sup>



**223491**  
**CUILLÈRE À SOUPE ANGLAISE**  
BOUILLON SPOON, ROUND  
L 185 mm L 7 in<sup>5/16</sup>



**223492**  
**CUILLÈRE À SODA**  
ICED TEASPOON / LONGDRINK  
L 189 mm L 7 in<sup>7/16</sup>



**223486**  
**CUILLÈRE À DESSERT**  
SOUP / DESSERT SPOON, OVAL  
L 195 mm L 7 in<sup>11/16</sup>



**223489**  
**FOURCHETTE À GÂTEAUX**  
COCKTAIL / PASTRY FORK  
L 139 mm L 5 in<sup>1/2</sup>



**223485**  
**FOURCHETTE À DESSERT**  
SALAD / DESSERT FORK  
L 192 mm L 7 in<sup>7/16</sup>



**223493**  
**FOURCHETTE DE SERVICE**  
SERVING FORK  
L 266 mm L 10 in<sup>1/2</sup>



**210630**  
**COUTEAU À DESSERT**  
**MONOBLOC LAME SCIE**  
DESSERT KNIFE, 1 PC SOLID  
HANDLE, SERRATED  
L 209 mm L 8 in<sup>1/4</sup>



**223494**  
**CUILLÈRE DE SERVICE**  
SERVING SPOON  
L 270 mm L 10 in<sup>5/8</sup>



**203016**  
**COUTEAU À BEURRE**  
**MONOBLOC LAME UNIE**  
BUTTER KNIFE, 1 PC SOLID  
HANDLE  
L 193 mm L 7 in<sup>5/8</sup>



**223497**  
**PELLE À TARTE**  
PASTRY SERVER, SOLID  
HANDLE  
L 251 mm L 9 in<sup>7/8</sup>





# GUEST VINTAGE



**217139**  
**FOURCHETTE DE TABLE**  
TABLE FORK  
L 213 mm L 8 in<sup>3/8</sup>



**217140**  
**COUTEAU DE TABLE MONOBLOC LAME SCIE**  
TABLE KNIFE, 1 PC SOLID HANDLE, SERRATED  
L 232 mm L 9 in<sup>1/8</sup>



**230339**  
**COUTEAU À STEAK MONOBLOC LAME SCIE**  
STEAK KNIFE, 1 PC SOLID HANDLE, SERRATED  
L 232 mm L 9 in<sup>1/8</sup>



**217141**  
**CUILLÈRE DE TABLE**  
TABLE / PASTA SPOON  
L 216 mm L 8 in<sup>1/2</sup>



**217143**  
**CUILLÈRE À DESSERT**  
SOUP / DESSERT SPOON, OVAL  
L 195 mm L 7 in<sup>11/16</sup>



**217144**  
**FOURCHETTE À DESSERT**  
SALAD / DESSERT FORK  
L 192 mm L 7 in<sup>9/16</sup>



**217145**  
**COUTEAU À DESSERT MONOBLOC LAME SCIE**  
DESSERT KNIFE, 1 PC SOLID HANDLE, SERRATED  
L 209 mm L 8 in<sup>1/4</sup>



**217142**  
**CUILLÈRE À CAFÉ**  
COFFEE / TEASPOON  
L 143 mm L 5 in<sup>5/8</sup>



**217146**  
**CUILLÈRE À MOKA**  
DEMITASSE / ESPRESSO SPOON  
L 117 mm L 4 in<sup>5/8</sup>



18-10



ARTICLES SUPPLÉMENTAIRES DE FINITION VINTAGE DISPONIBLES SUR DEMANDE  
ADDITIONAL VINTAGE FINISH ITEMS AVAILABLE UPON REQUEST





**239122**  
**FOURCHETTE DE TABLE**  
 TABLE FORK  
 L 205 mm L 8 in<sup>1/16</sup>



**239123**  
**COUTEAU DE TABLE MONOBLOC LAME SCIE BOUT POINTU**  
 TABLE KNIFE, 1 PC SOLID HANDLE, SERRATED, POINTED BLADE  
 L 233 mm L 9 in<sup>3/16</sup>



**239124**  
**COUTEAU DE TABLE MONOBLOC LAME SCIE BOUT ROND**  
 TABLE KNIFE, 1 PC SOLID HANDLE, SERRATED, ROUND BLADE  
 L 233 mm L 9 in<sup>3/16</sup>



**239121**  
**CUILLÈRE DE TABLE**  
 TABLE / PASTA SPOON  
 L 205 mm L 8 in<sup>1/16</sup>



**239132**  
**CUILLÈRE À SOUPE ANGLAISE**  
 BOUILLON SPOON, ROUND  
 L 185 mm L 7 in<sup>5/16</sup>



**239128**  
**CUILLÈRE À DESSERT**  
 SOUP / DESSERT SPOON, OVAL  
 L 185 mm L 7 in<sup>5/16</sup>



**239127**  
**FOURCHETTE À DESSERT**  
 SALAD / DESSERT FORK  
 L 185 mm L 7 in<sup>5/16</sup>



**239129**  
**COUTEAU À DESSERT MONOBLOC LAME UNIE**  
 DESSERT KNIFE, 1 PC SOLID HANDLE  
 L 209 mm L 8 in<sup>1/4</sup>



**239133**  
**COUTEAU À BEURRE MONOBLOC LAME UNIE**  
 BUTTER KNIFE, 1 PC SOLID HANDLE  
 L 175 mm L 6 in<sup>7/8</sup>



**239125**  
**CUILLÈRE À CAFÉ**  
 COFFEE / TEASPOON  
 L 139 mm L 5 in<sup>1/2</sup>



**239126**  
**CUILLÈRE À MOKA**  
 DEMITASSE / ESPRESSO SPOON  
 L 117 mm L 4 in<sup>5/8</sup>



**239134**  
**FOURCHETTE DE SERVICE**  
 SERVING FORK  
 L 263 mm L 10 in<sup>3/8</sup>



**239135**  
**CUILLÈRE DE SERVICE**  
 SERVING SPOON  
 L 263 mm L 10 in<sup>3/8</sup>



# NORWAY



**111894**  
**FOURCHETTE DE TABLE**  
TABLE FORK  
L 204 mm L 8 in<sup>1/16</sup>



**111921**  
**COUTEAU DE TABLE MONOBLOC LAME SCIE**  
TABLE KNIFE, 1 PC SOLID HANDLE, SERRATED  
L 230 mm L 9 in<sup>1/16</sup>



**111891**  
**CUILLÈRE DE TABLE**  
TABLE / PASTA SPOON  
L 204 mm L 8 in<sup>1/16</sup>



**111904**  
**CUILLÈRE À DESSERT**  
SOUP / DESSERT SPOON, OVAL  
L 180 mm L 7 in<sup>1/16</sup>



**111907**  
**FOURCHETTE À DESSERT**  
SALAD / DESSERT FORK  
L 180 mm L 7 in<sup>1/16</sup>



**210631**  
**COUTEAU À DESSERT MONOBLOC LAME SCIE**  
DESSERT KNIFE, 1 PC SOLID HANDLE, SERRATED  
L 203 mm L 8 in



**181112**  
**TARTINEUR MONOBLOC LAME UNIE XY**  
BUTTER KNIFE, 1 PC SOLID HANDLE  
L 160 mm L 6 in<sup>5/16</sup>



**111897**  
**CUILLÈRE À CAFÉ**  
COFFEE / TEASPOON  
L 136 mm L 5 in<sup>3/8</sup>



**114437**  
**CUILLÈRE À MOKA**  
DEMITASSE / ESPRESSO SPOON  
L 110 mm L 4 in<sup>5/16</sup>



18-10



2,5

POSSIBILITÉ DE PERSONNALISATION  
BESPOKE OPTIONS AVAILABLE



ÉGALEMENT DISPONIBLE EN MÉTAL ARGENTÉ SUR DEMANDE  
ALSO AVAILABLE IN SILVERPLATED FINISH ON DEMAND



# ONDE



**235927**  
FOURCHETTE DE TABLE  
TABLE FORK  
L 199 mm L 7 in<sup>13/16</sup>



**235931**  
COUTEAU DE TABLE  
MONOBLOC LAME SCIE  
TABLE KNIFE, 1 PC SOLID  
HANDLE, SERRATED  
L 232 mm L 9 in<sup>1/8</sup>



**235930**  
COUTEAU DE TABLE  
MONOBLOC LAME SCIE DROIT  
TABLE KNIFE, 1 PC SOLID  
HANDLE, SERRATED, STRAIGHT  
BLADE  
L 232 mm L 9 in<sup>1/8</sup>



**235928**  
CUILLÈRE DE TABLE  
TABLE / PASTA SPOON  
L 199 mm L 7 in<sup>13/16</sup>



**235938**  
CUILLÈRE À SOUPE ANGLAISE  
BOUILLON SPOON, ROUND  
L 184 mm L 7 in<sup>1/4</sup>



**235934**  
CUILLÈRE À DESSERT  
SOUP / DESSERT SPOON, OVAL  
L 184 mm L 7 in<sup>1/4</sup>



**235933**  
FOURCHETTE À DESSERT  
SALAD / DESSERT FORK  
L 184 mm L 7 in<sup>1/4</sup>



**235935**  
COUTEAU À DESSERT  
MONOBLOC LAME SCIE  
DESSERT KNIFE, 1 PC SOLID  
HANDLE, SERRATED  
L 209 mm L 8 in<sup>1/4</sup>



**235936**  
COUTEAU À DESSERT  
MONOBLOC LAME UNIE  
DESSERT KNIFE, 1 PC SOLID  
HANDLE  
L 209 mm L 8 in<sup>1/4</sup>



**235939**  
COUTEAU À BEURRE  
MONOBLOC LAME UNIE  
BUTTER KNIFE, 1 PC SOLID  
HANDLE  
L 165 mm L 6 in<sup>1/2</sup>



**235929**  
CUILLÈRE À CAFÉ  
COFFEE / TEASPOON  
L 139 mm L 5 in<sup>1/2</sup>



**235932**  
CUILLÈRE À MOKA  
DEMITASSE / ESPRESSO  
SPOON  
L 109 mm L 4 in<sup>9/16</sup>



**235937**  
FOURCHETTE À GÂTEAUX  
COCKTAIL / PASTRY FORK  
L 141 mm L 5 in<sup>9/16</sup>

## SUGGESTION PIÈCES COMPLÉMENTAIRES SUGGESTED ADDITIONAL PIECES TYPE GOUTTE



**231218**  
FOURCHETTE DE SERVICE  
SERVING FORK  
L 266 mm L 10 in<sup>1/2</sup>



**231219**  
CUILLÈRE DE SERVICE  
SERVING SPOON  
L 266 mm L 10 in<sup>1/2</sup>



**231221**  
PELLE À TARTE  
PASTRY SERVER, SOLID  
HANDLE  
L 252 mm L 9 in<sup>15/16</sup>



**231220**  
LOUCHE  
SOUP LADLE  
L 290 mm L 11 in<sup>7/16</sup>



18-10



POSSIBILITÉ DE PERSONNALISATION  
BESPOKE OPTIONS AVAILABLE



ÉGALEMENT DISPONIBLE EN MÉTAL ARGENTÉ SUR DEMANDE  
ALSO AVAILABLE IN SILVERPLATED FINISH ON DEMAND





# ONDE GOLD



**236968**  
**FOURCHETTE DE TABLE**  
 TABLE FORK  
 L 199 mm L 7 in<sup>13/16</sup>



**236974**  
**CUILLÈRE À CAFÉ**  
 COFFEE / TEASPOON  
 L 139 mm L 5 in<sup>1/2</sup>



**239336**  
**COUTEAU DE TABLE**  
**MONOBLOC LAME SCIE**  
 TABLE KNIFE, 1 PC SOLID  
 HANDLE, SERRATED  
 L 232 mm L 9 in<sup>1/8</sup>



**236975**  
**CUILLÈRE À MOKA**  
 DEMITASSE / ESPRESSO  
 SPOON  
 L 109 mm L 4 in<sup>5/16</sup>



**236970**  
**CUILLÈRE DE TABLE**  
 TABLE / PASTA SPOON  
 L 199 mm L 7 in<sup>13/16</sup>



**236977**  
**FOURCHETTE À GÂTEAUX**  
 COCKTAIL / PASTRY FORK  
 L 141 mm L 5 in<sup>9/16</sup>



**236976**  
**CUILLÈRE À SOUPE ANGLAISE**  
 BOUILLON SPOON, ROUND  
 L 184 mm L 7 in<sup>1/4</sup>



**236981**  
**FOURCHETTE DE SERVICE**  
 SERVING FORK  
 L 266 mm L 10 in<sup>1/2</sup>



**236971**  
**CUILLÈRE À DESSERT**  
 SOUP / DESSERT SPOON, OVAL  
 L 184 mm L 7 in<sup>1/4</sup>



**236982**  
**CUILLÈRE DE SERVICE**  
 SERVING SPOON  
 L 266 mm L 10 in<sup>1/2</sup>



**236972**  
**FOURCHETTE À DESSERT**  
 SALAD / DESSERT FORK  
 L 184 mm L 7 in<sup>1/4</sup>



**237180**  
**PELLE À TARTE**  
 PASTRY SERVER, SOLID  
 HANDLE  
 L 252 mm L 9 in<sup>15/16</sup>



**239337**  
**COUTEAU À DESSERT**  
**MONOBLOC LAME SCIE**  
 DESSERT KNIFE, 1 PC SOLID  
 HANDLE, SERRATED  
 L 209 mm L 8 in<sup>1/4</sup>



**236978**  
**COUTEAU À BEURRE**  
**MONOBLOC LAME UNIE**  
 BUTTER KNIFE, 1 PC SOLID  
 HANDLE  
 L 165 mm L 6 in<sup>1/2</sup>



# OVATION

MADE IN FRANCE



**163598**  
**FOURCHETTE DE TABLE**  
TABLE FORK  
L 201 mm L 7 in<sup>15/16</sup>



**111970**  
**COUTEAU DE TABLE MONOBLOC LAME SCIE**  
TABLE KNIFE, 1 PC SOLID HANDLE, SERRATED  
L 230 mm L 9 in<sup>1/16</sup>



**163597**  
**CUILLÈRE DE TABLE**  
TABLE / PASTA SPOON  
L 204 mm L 8 in<sup>1/16</sup>



**163602**  
**CUILLÈRE À DESSERT**  
SOUP / DESSERT SPOON, OVAL  
L 184 mm L 7 in<sup>1/4</sup>



**163603**  
**FOURCHETTE À DESSERT**  
SALAD / DESSERT FORK  
L 182 mm L 7 in<sup>3/16</sup>



**111976**  
**COUTEAU À DESSERT MONOBLOC LAME SCIE**  
DESSERT KNIFE, 1 PC SOLID HANDLE, SERRATED  
L 204 mm L 8 in<sup>1/16</sup>



**181112**  
**TARTINEUR MONOBLOC LAME UNIE XY**  
BUTTER KNIFE, 1 PC SOLID HANDLE  
L 160 mm L 6 in<sup>5/16</sup>



**163599**  
**CUILLÈRE À CAFÉ**  
COFFEE / TEASPOON  
L 140 mm L 5 in<sup>1/2</sup>



18-10



POSSIBILITÉ DE PERSONNALISATION  
BESPOKE OPTIONS AVAILABLE



ÉGALEMENT DISPONIBLE EN MÉTAL ARGENTÉ SUR DEMANDE  
ALSO AVAILABLE IN SILVERPLATED FINISH ON DEMAND



# RIVAGE



**246423**  
**FOURCHETTE DE TABLE**  
 TABLE FORK  
 L 211 mm L 8 in<sup>5/16</sup>



**246445**  
**COUTEAU À BEURRE**  
**MONOBLOC LAME UNIE**  
 BUTTER KNIFE, 1 PC SOLID  
 HANDLE  
 L 183 mm L 7 in<sup>3/16</sup>



**246427**  
**COUTEAU DE TABLE**  
**MONOBLOC LAME SCIE**  
 TABLE KNIFE, 1 PC SOLID  
 HANDLE, SERRATED  
 L 235 mm L 9 in<sup>1/4</sup>



**246435**  
**CUILLÈRE À CAFÉ**  
 COFFEE / TEASPOON  
 L 145 mm L 5 in<sup>11/16</sup>



**246425**  
**CUILLÈRE DE TABLE**  
 TABLE / PASTA SPOON  
 L 209 mm L 8 in<sup>1/4</sup>



**246437**  
**CUILLÈRE À MOKA**  
 DEMITASSE / ESPRESSO  
 SPOON  
 L 116 mm L 4 in<sup>9/16</sup>



**246439**  
**CUILLÈRE À SOUPE ANGLAISE**  
 BOUILLON SPOON, ROUND  
 L 182 mm L 7 in<sup>3/16</sup>



**246443**  
**FOURCHETTE À GÂTEAUX**  
 COCKTAIL / PASTRY FORK  
 L 145 mm L 5 in<sup>11/16</sup>



**246431**  
**CUILLÈRE À DESSERT**  
 SOUP / DESSERT SPOON, OVAL  
 L 190 mm L 7 in<sup>1/2</sup>



**246447**  
**CUILLÈRE DE SERVICE**  
 SERVING SPOON  
 L 263 mm L 10 in<sup>3/8</sup>



**246429**  
**FOURCHETTE À DESSERT /**  
**POISSON**  
 FISH / SALAD / DESSERT FORK,  
 3 TINE  
 L 190 mm L 7 in<sup>1/2</sup>



**246448**  
**FOURCHETTE DE SERVICE**  
 SERVING FORK  
 L 263 mm L 10 in<sup>3/8</sup>



**246441**  
**COUTEAU À POISSON GOURMET**  
 FISH / GOURMET KNIFE  
 L 205 mm L 8 in<sup>1/16</sup>



**246433**  
**COUTEAU À DESSERT**  
**MONOBLOC LAME UNIE**  
 DESSERT KNIFE, 1 PC SOLID  
 HANDLE  
 L 211 mm L 8 in<sup>5/16</sup>



# SOLSTICE



**205540**  
**FOURCHETTE DE TABLE**  
TABLE FORK  
L 209 mm L 8 in<sup>1/4</sup>



**205544**  
**FOURCHETTE À POISSON**  
FISH FORK, 3 TINE  
L 184 mm L 7 in<sup>1/4</sup>



**159484**  
**COUTEAU DE TABLE**  
**MONOBLOC LAME SCIE N°1**  
TABLE KNIFE, 1 PC SOLID  
HANDLE, SERRATED, N°1  
L 232 mm L 9 in<sup>1/8</sup>



**205545**  
**COUTEAU À POISSON**  
**GOURMET**  
FISH / GOURMET KNIFE  
L 207 mm L 8 in<sup>1/8</sup>



**235481**  
**COUTEAU DE TABLE**  
**MONOBLOC LAME SCIE BOUT**  
**ROND GUEST**  
TABLE KNIFE, 1 PC SOLID  
HANDLE, SERRATED, ROUND  
BLADE  
L 237 mm L 9 in<sup>5/16</sup>



**205543**  
**CUILLÈRE À CAFÉ**  
COFFEE / TEASPOON  
L 141 mm L 5 in<sup>7/16</sup>



**159451**  
**COUTEAU À STEAK MONOBLOC**  
**LAME SCIE**  
STEAK KNIFE, 1 PC SOLID  
HANDLE, SERRATED  
L 235 mm L 9 in<sup>1/4</sup>



**159512**  
**CUILLÈRE À MOKA**  
DEMITASSE / ESPRESSO  
SPOON  
L 111 mm L 4 in<sup>3/8</sup>



**205541**  
**CUILLÈRE DE TABLE**  
TABLE / PASTA SPOON  
L 210 mm L 8 in<sup>1/4</sup>



**190018**  
**CUILLÈRE À SODA TYPE DROIT**  
ICED TEASPOON / LONGDRINK  
L 189 mm L 7 in<sup>7/16</sup>



**205547**  
**CUILLÈRE À DESSERT**  
SOUP / DESSERT SPOON, OVAL  
L 186 mm L 7 in<sup>5/16</sup>



**205548**  
**FOURCHETTE À GÂTEAUX**  
COCKTAIL / PASTRY FORK  
L 143 mm L 5 in<sup>5/8</sup>



**205546**  
**FOURCHETTE À DESSERT**  
SALAD / DESSERT FORK  
L 184 mm L 7 in<sup>1/4</sup>



**190424**  
**FOURCHETTE À HÛITRES**  
**TYPE DROIT**  
OYSTER / SHELLFISH FORK  
L 141 mm L 5 in<sup>9/16</sup>



**159492**  
**COUTEAU À DESSERT**  
**MONOBLOC LAME UNIE N°1**  
DESSERT KNIFE, 1 PC SOLID  
HANDLE, N°1  
L 204 mm L 8 in<sup>1/16</sup>



**159501**  
**FOURCHETTE DE SERVICE**  
SERVING FORK  
L 260 mm L 10 in<sup>1/4</sup>



**235482**  
**COUTEAU À DESSERT**  
**MONOBLOC LAME UNIE BOUT**  
**ROND GUEST**  
DESSERT KNIFE, 1 PC SOLID  
HANDLE, ROUND BLADE  
L 213 mm L 8 in<sup>3/8</sup>



**159500**  
**CUILLÈRE DE SERVICE**  
SERVING SPOON  
L 260 mm L 10 in<sup>1/4</sup>



**181112**  
**TARTINEUR MONOBLOC LAME**  
**UNIE XY**  
BUTTER KNIFE, 1 PC SOLID  
HANDLE  
L 160 mm L 6 in<sup>5/16</sup>



**153193**  
**LOUCHE TYPE DROIT**  
SOUP LADLE  
L 297 mm L 11 in<sup>11/16</sup>



**154606**  
**LOUCHE À SAUCE TYPE DROIT**  
SAUCE LADLE  
L 185 mm L 7 in<sup>5/16</sup>



POSSIBILITÉ DE PERSONNALISATION  
BESPOKE OPTIONS AVAILABLE



ÉGALEMENT DISPONIBLE EN MÉTAL ARGENTÉ SUR DEMANDE  
ALSO AVAILABLE IN SILVERPLATED FINISH ON DEMAND





# SUPERNATURE

MADE IN FRANCE



**242668**  
**FOURCHETTE DE TABLE**  
TABLE FORK  
L 201 mm L 7 in<sup>15/16</sup>



**242674**  
**COUTEAU DE TABLE MONOBLOC LAME SCIE**  
TABLE KNIFE, 1 PC SOLID HANDLE, SERRATED  
L 235 mm L 9 in<sup>1/4</sup>



**242665**  
**CUILLÈRE DE TABLE**  
TABLE / PASTA SPOON  
L 203 mm L 8 in



**242689**  
**CUILLÈRE À SOUPE ANGLAISE**  
BOUILLON SPOON, ROUND  
L 178 mm L 7 in



**242677**  
**CUILLÈRE À DESSERT**  
SOUP / DESSERT SPOON, OVAL  
L 178 mm L 7 in



**242680**  
**FOURCHETTE À DESSERT**  
SALAD / DESSERT FORK  
L 177 mm L 6 in<sup>15/16</sup>



**242683**  
**COUTEAU À DESSERT MONOBLOC LAME UNIE**  
DESSERT KNIFE, 1 PC SOLID HANDLE  
L 207 mm L 8 in<sup>1/8</sup>



**242705**  
**COUTEAU À BEURRE MONOBLOC LAME UNIE**  
BUTTER KNIFE, 1 PC SOLID HANDLE  
L 181 mm L 7 in<sup>1/8</sup>



**242671**  
**CUILLÈRE À CAFÉ**  
COFFEE / TEASPOON  
L 138 mm L 5 in<sup>7/16</sup>



**242686**  
**CUILLÈRE À MOKA**  
DEMITASSE / ESPRESSO SPOON  
L 112 mm L 4 in<sup>7/16</sup>

## SUGGESTION PIÈCES COMPLÉMENTAIRES SUGGESTED ADDITIONAL PIECES AQUATIC



**126377**  
**FOURCHETTE À POISSON**  
FISH FORK, 3 TINE  
L 177 mm L 6 in<sup>15/16</sup>



**181181**  
**COUTEAU À POISSON GOURMET**  
FISH / GOURMET KNIFE  
L 200 mm L 7 in<sup>7/8</sup>







**205559**  
**FOURCHETTE DE TABLE**  
TABLE FORK  
L 213 mm L 8 in<sup>3/8</sup>



**193776**  
**COUTEAU DE TABLE**  
**MONOBLOC LAME SCIE**  
TABLE KNIFE, 1 PC SOLID  
HANDLE, SERRATED  
L 233 mm L 9 in<sup>3/16</sup>



**205560**  
**CUILLÈRE DE TABLE**  
TABLE / PASTA SPOON  
L 205 mm L 8 in<sup>1/16</sup>



**205561**  
**CUILLÈRE À SOUPE ANGLAISE**  
BOUILLON SPOON, ROUND  
L 185 mm L 7 in<sup>3/16</sup>



**205567**  
**CUILLÈRE À DESSERT**  
SOUP / DESSERT SPOON, OVAL  
L 188 mm L 7 in<sup>3/8</sup>



**205566**  
**FOURCHETTE GOURMANDE**  
DESSERT FORK  
L 186 mm L 7 in<sup>3/16</sup>



**181111**  
**COUTEAU À DESSERT**  
**MONOBLOC LAME UNIE**  
DESSERT KNIFE, 1 PC SOLID  
HANDLE  
L 206 mm L 8 in<sup>1/8</sup>



**181112**  
**TARTINEUR MONOBLOC LAME**  
**UNIE**  
BUTTER KNIFE, 1 PC SOLID  
HANDLE  
L 160 mm L 6 in<sup>5/16</sup>



**205563**  
**FOURCHETTE À POISSON**  
FISH FORK, 3 TINE  
L 200 mm L 7 in<sup>7/8</sup>



**205564**  
**SPATULE GOURMET**  
GOURMET SPATULA  
L 202 mm L 7 in<sup>15/16</sup>



**205565**  
**FOURCHETTE GOURMET**  
GOURMET FORK  
L 200 mm L 7 in<sup>7/8</sup>



**205562**  
**CUILLÈRE À CAFÉ**  
COFFEE / TEASPOON  
L 143 mm L 5 in<sup>5/8</sup>



**181109**  
**CUILLÈRE À MOKA**  
DEMITASSE / ESPRESSO  
SPOON  
L 110 mm L 4 in<sup>5/16</sup>



**190018**  
**CUILLÈRE À SODA TYPE DROIT**  
ICED TEASPOON / LONGDRINK  
L 189 mm L 7 in<sup>7/16</sup>



**181119**  
**FOURCHETTE DE MISE EN**  
**BOUCHE**  
APPETIZER FORK  
L 155 mm L 6 in<sup>1/8</sup>



**181120**  
**SPATULE DE MISE EN BOUCHE**  
APPETIZER SPATULA  
L 155 mm L 6 in<sup>1/8</sup>



**181121**  
**CUILLÈRE DE MISE EN BOUCHE**  
APPETIZER SPOON  
L 116 mm L 4 in<sup>3/16</sup>



**190424**  
**FOURCHETTE À HÙITRES**  
**TYPE DROIT**  
OYSTER / SHELLFISH FORK  
L 141 mm L 5 in<sup>3/16</sup>



**181114**  
**FOURCHETTE DE SERVICE**  
SERVING FORK  
L 260 mm L 10 in<sup>1/4</sup>



**181113**  
**CUILLÈRE DE SERVICE**  
SERVING SPOON  
L 260 mm L 10 in<sup>1/4</sup>



**181122**  
**PELLE À TARTE**  
PASTRY SERVER, SOLID  
HANDLE  
L 250 mm L 9 in<sup>13/16</sup>



**189999**  
**COUVERTS À SALADE**  
SALAD SERVING SET, 2 PCS  
L 300 mm L 11 in<sup>13/16</sup>



**153193**  
**LOUCHE TYPE DROIT**  
SOUP LADLE  
L 297 mm L 11 in<sup>11/16</sup>



**154606**  
**LOUCHE À SAUCE TYPE DROIT**  
SAUCE LADLE  
L 185 mm L 7 in<sup>5/16</sup>



POSSIBILITÉ DE PERSONNALISATION  
BESPOKE OPTIONS AVAILABLE



ÉGALEMENT DISPONIBLE EN MÉTAL ARGENTÉ SUR DEMANDE  
ALSO AVAILABLE IN SILVERPLATED FINISH ON DEMAND



# XY BLACK



**205568**  
**FOURCHETTE DE TABLE**  
TABLE FORK  
L 213 mm L 8 in<sup>3/8</sup>



**195028**  
**COUPEAU DE TABLE**  
**MONOBLOC LAME SCIE**  
TABLE KNIFE, 1 PC SOLID  
HANDLE, SERRATED  
L 233 mm L 9 in<sup>3/16</sup>



**205569**  
**CUILLÈRE DE TABLE**  
TABLE / PASTA SPOON  
L 205 mm L 8 in<sup>1/16</sup>



**200483**  
**CUILLÈRE À SOUPE ANGLAISE**  
BOUILLON SPOON, ROUND  
L 185 mm L 7 in<sup>3/16</sup>



**205575**  
**CUILLÈRE À DESSERT**  
SOUP / DESSERT SPOON, OVAL  
L 188 mm L 7 in<sup>3/8</sup>



**205574**  
**FOURCHETTE GOURMANDE**  
DESSERT FORK  
L 186 mm L 7 in<sup>5/16</sup>



**195031**  
**COUPEAU À DESSERT**  
**MONOBLOC LAME UNIE**  
DESSERT KNIFE, 1 PC SOLID  
HANDLE  
L 206 mm L 8 in<sup>1/8</sup>



**195036**  
**TARTINEUR MONOBLOC LAME**  
**UNIE**  
BUTTER KNIFE, 1 PC SOLID  
HANDLE  
L 160 mm L 6 in<sup>5/16</sup>



**205571**  
**FOURCHETTE À POISSON**  
FISH FORK, 3 TINE  
L 200 mm L 7 in<sup>7/8</sup>



**205572**  
**SPATULE GOURMET**  
GOURMET SPATULA  
L 202 mm L 7 in<sup>15/16</sup>



**205573**  
**FOURCHETTE GOURMET**  
GOURMET FORK  
L 200 mm L 7 in<sup>7/8</sup>



**205570**  
**CUILLÈRE À CAFÉ**  
COFFEE / TEASPOON  
L 143 mm L 5 in<sup>5/8</sup>



**195034**  
**CUILLÈRE À MOKA**  
DEMITASSE / ESPRESSO  
SPOON  
L 110 mm L 4 in<sup>5/16</sup>



**196674**  
**CUILLÈRE À SODA**  
ICED TEASPOON / LONGDRINK  
L 189 mm L 7 in<sup>7/16</sup>



**195039**  
**FOURCHETTE DE MISE EN**  
**BOUCHE**  
APPETIZER FORK  
L 155 mm L 6 in<sup>1/8</sup>



**195042**  
**SPATULE DE MISE EN BOUCHE**  
APPETIZER SPATULA  
L 155 mm L 6 in<sup>1/8</sup>



**195041**  
**CUILLÈRE DE MISE EN BOUCHE**  
APPETIZER SPOON  
L 116 mm L 4 in<sup>7/16</sup>



**196014**  
**FOURCHETTE À HÙÎTRES**  
OYSTER / SHELLFISH FORK  
L 141 mm L 5 in<sup>9/16</sup>



**199773**  
**FOURCHETTE DE SERVICE**  
SERVING FORK  
L 260 mm L 10 in<sup>1/4</sup>



**199774**  
**CUILLÈRE DE SERVICE**  
SERVING SPOON  
L 260 mm L 10 in<sup>1/4</sup>



**199771**  
**COUVERTS À SALADE**  
SALAD SERVING SET, 2 PCS  
L 300 mm L 11 in<sup>13/16</sup>



**199769**  
**PELLE À TARTE**  
PASTRY SERVER, SOLID  
HANDLE  
L 250 mm L 9 in<sup>13/16</sup>



PVD

18-10



POSSIBILITÉ DE PERSONNALISATION  
BESPOKE OPTIONS AVAILABLE



LES PIÈCES  
COMPLÉMENTAIRES  
ADDITIONAL PIECES

COUTEAUX À STEAK . . . . .	95
Le Phil	
Le Phil Vintage	
Mirage Les Essences	
Mirage Anthracite	
Mirage Blanc	
COUTEAUX À STEAK	
MANCHE ORFÈVRE . . . . .	96
COUTEAUX À STEAK MONOBLOC .	97
ACCESSOIRES PLATERIE . . . . .	99
CUILLÈRES À SODA . . . . .	99
FOURCHETTES À HUÎTRE . . . . .	99
FOURCHETTES À ESCARGOT . . . .	99
MODULO . . . . .	99
BLOIS . . . . .	100
VERLAINE . . . . .	100
PETIT GOURMET . . . . .	101
TYPE DROIT . . . . .	101
TYPE GOUTTE . . . . .	101
XY . . . . .	101





# COUTEAUX À STEAK

## STEAK KNIVES



### LE PHIL



246174  
COUTEAU À STEAK MONOBLOC LAME UNIE  
STEAK KNIFE, 1 PC SOLID HANDLE  
L 238 mm L 9 in<sup>3/8</sup>

### LE PHIL VINTAGE



247404  
COUTEAU À STEAK MONOBLOC LAME SCIE  
STEAK KNIFE, 1 PC SOLID HANDLE, SERRATED  
L 238 mm L 9 in<sup>3/8</sup>

### MIRAGE LES ESSENCES



243524  
COUTEAU À STEAK MANCHE OLIVIER  
STEAK KNIFE  
L 230 mm L 9 in<sup>1/16</sup>



243528  
COUTEAU À STEAK MANCHE PICANA  
STEAK KNIFE  
L 230 mm L 9 in<sup>1/16</sup>



243525  
COUTEAU À STEAK MANCHE ÉBÈNE  
STEAK KNIFE  
L 230 mm L 9 in<sup>1/16</sup>

### MIRAGE



226261  
COUTEAU À STEAK LAME UNIE  
STEAK KNIFE  
L 230 mm L 9 in<sup>1/16</sup>



226263  
COUTEAU À STEAK LAME UNIE  
STEAK KNIFE  
L 230 mm L 9 in<sup>1/16</sup>

# COUTEAUX À STEAK MANCHE ORFÈVRE

## STEAK KNIVES HOLLOW HANDLE



**122759**  
**COUTEAU À STEAK MANCHE ORFÈVRE LAME SCIE BLOIS**  
STEAK KNIFE, HOLLOW HANDLE, SERRATED  
L 238 mm L 9 in<sup>3/8</sup>



**127654**  
**COUTEAU À STEAK MANCHE ORFÈVRE LAME SCIE FLORENCIA**  
STEAK KNIFE, HOLLOW HANDLE, SERRATED  
L 238 mm L 9 in<sup>3/8</sup>



**122746**  
**COUTEAU À STEAK MANCHE ORFÈVRE LAME SCIE LUTÈCE**  
STEAK KNIFE, HOLLOW HANDLE, SERRATED  
L 238 mm L 9 in<sup>3/8</sup>



**186278**  
**COUTEAU À STEAK MANCHE ORFÈVRE LAME SCIE MARQUISE**  
STEAK KNIFE, HOLLOW HANDLE, SERRATED  
L 238 mm L 9 in<sup>3/8</sup>



**128841**  
**COUTEAU À STEAK MANCHE ORFÈVRE LAME SCIE MILADY**  
STEAK KNIFE, HOLLOW HANDLE, SERRATED  
L 238 mm L 9 in<sup>3/8</sup>



**105801**  
**COUTEAU À STEAK MANCHE ORFÈVRE LAME SCIE VERLAINE**  
STEAK KNIFE, HOLLOW HANDLE, SERRATED  
L 238 mm L 9 in<sup>3/8</sup>

# COUTEAUX À STEAK MONOBLOC

STEAK KNIVES 1 PIECE SOLID HANDLE



**199761**  
**COUTEAU À STEAK MONOBLOC LAME SCIE ASTRÉE CISELÉ**  
STEAK KNIFE, 1 PC SOLID HANDLE, SERRATED  
L 228 mm L 9 in



**160433**  
**COUTEAU À STEAK MONOBLOC LAME SCIE CONFIDENCE**  
STEAK KNIFE, 1 PC SOLID HANDLE, SERRATED  
L 239 mm L 9 in<sup>7/16</sup>



**159451**  
**COUTEAU À STEAK MONOBLOC LAME SCIE GOURMETS**  
STEAK KNIFE, 1 PC SOLID HANDLE, SERRATED  
L 235 mm L 9 in<sup>1/4</sup>



**197521**  
**COUTEAU À STEAK MONOBLOC LAME SCIE GUEST**  
STEAK KNIFE, 1 PC SOLID HANDLE, SERRATED  
L 232 mm L 9 in<sup>1/8</sup>



**203017**  
**COUTEAU À STEAK MONOBLOC LAME SCIE GUEST STAR**  
STEAK KNIFE, 1 PC SOLID HANDLE, SERRATED  
L 232 mm L 9 in<sup>1/8</sup>



**230339**  
**COUTEAU À STEAK MONOBLOC LAME SCIE GUEST VINTAGE**  
STEAK KNIFE, 1 PC SOLID HANDLE, SERRATED  
L 232 mm L 9 in<sup>1/8</sup>



**160427**  
**COUTEAU À STEAK MONOBLOC LAME SCIE MIKADO**  
STEAK KNIFE, 1 PC SOLID HANDLE, SERRATED  
L 239 mm L 9 in<sup>7/16</sup>



**230293**  
**COUTEAU À STEAK MONOBLOC LAME SCIE MIKADO VINTAGE**  
STEAK KNIFE, 1 PC SOLID HANDLE, SERRATED  
L 239 mm L 9 in<sup>7/16</sup>



**160424**  
**COUTEAU À STEAK MONOBLOC LAME SCIE VIEUX PARIS SATINÉ**  
STEAK KNIFE, 1 PC SOLID HANDLE, SERRATED  
L 233 mm L 9 in<sup>3/16</sup>



# PIÈCES COMPLÉMENTAIRES

## ADDITIONAL PIECES

### FOURCHETTES À HUÎTRES OYSTER FORKS

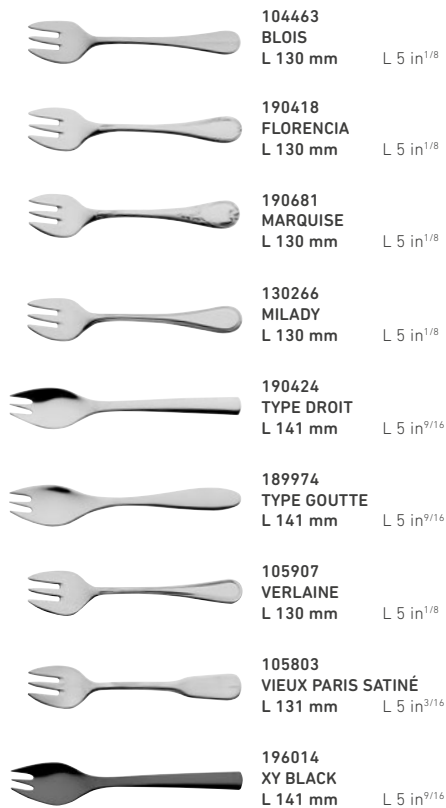

### CUILLÈRES À SODA ICED TEA SPOON



### FOURCHETTES À ESCARGOTS SNAIL FORKS

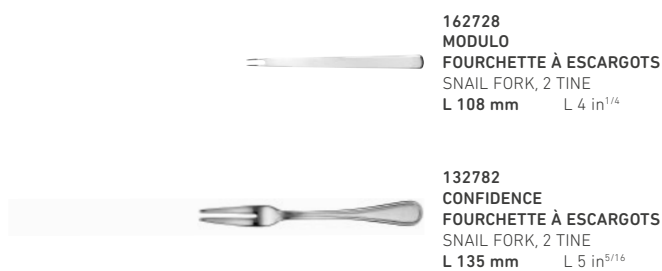

### MODULO

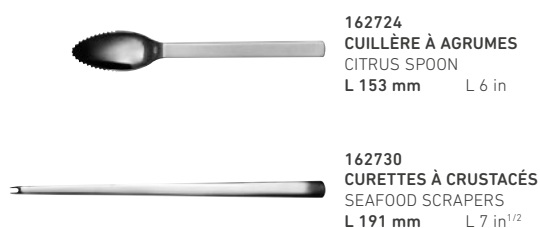

### ACCESSOIRES PLATERIE HOLLOWARE ACCESSORIES

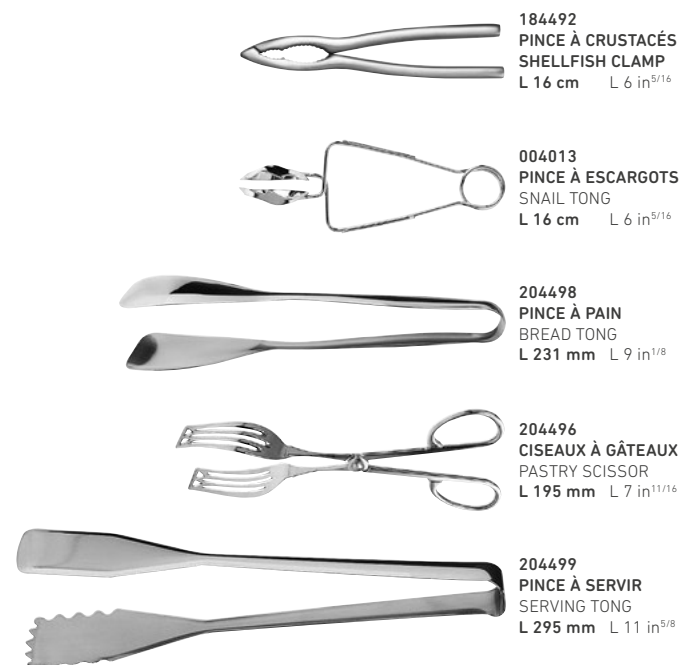

# PIÈCES COMPLÉMENTAIRES

## ADDITIONAL PIECES

### BLOIS



104480  
FOURCHETTE À GÂTEAUX  
COCKTAIL / PASTRY FORK  
L 138 mm L 5 in<sup>7/16</sup>



195757  
FOURCHETTE DE SERVICE  
SERVING FORK  
L 247 mm L 9 in<sup>3/4</sup>



195755  
CUILLÈRE DE SERVICE  
SERVING SPOON  
L 249 mm L 9 in<sup>13/16</sup>



195750  
COUVERTS À SALADE  
SALAD SERVING SET, 2 PCS  
L 257 mm L 10 in<sup>1/8</sup>



195753  
PELLE À TARTE  
PASTRY SERVER, SOLID  
HANDLE  
L 251 mm L 9 in<sup>7/8</sup>



195762  
LOUCHE  
SOUP LADLE  
L 286 mm L 11 in<sup>1/4</sup>



195759  
LOUCHE À SAUCE  
SAUCE LADLE  
L 160 mm L 6 in<sup>5/16</sup>



195757  
FOURCHETTE À DÉCOUPER  
CARVING FORK  
L 247 mm L 9 in<sup>3/4</sup>



189511  
COUTEAU À DÉCOUPER  
MANCHE ORFÈVRE LAME UNIE  
CARVING KNIFE, HOLLOW  
HANDLE  
L 286 mm L 11 in<sup>1/4</sup>

### VERLAINE



105795  
FOURCHETTE À GÂTEAUX  
COCKTAIL / PASTRY FORK  
L 138 mm L 5 in<sup>7/16</sup>



002185  
FOURCHETTE DE SERVICE  
SERVING FORK  
L 248 mm L 9 in<sup>3/4</sup>



002186  
CUILLÈRE DE SERVICE  
SERVING SPOON  
L 250 mm L 9 in<sup>13/16</sup>



040646  
COUVERTS À SALADE  
SALAD SERVING SET, 2 PCS  
L 257 mm L 10 in<sup>1/8</sup>



083340  
PELLE À TARTE  
PASTRY SERVER, SOLID HANDLE  
L 251 mm L 9 in<sup>7/8</sup>



097717  
LOUCHE  
SOUP LADLE  
L 305 mm L 12 in



002179  
LOUCHE À SAUCE  
SAUCE LADLE  
L 156 mm L 6 in<sup>1/8</sup>

# PIÈCES COMPLÉMENTAIRES

## ADDITIONAL PIECES

### XY



**181112**  
**TARTINEUR MONOBLOC LAME UNIE**  
BUTTER KNIFE, 1 PC SOLID HANDLE  
L 160 mm L 6 in<sup>5/16</sup>

### TYPE GOUTTE



**189971**  
**COUPEAU À BEURRE MONOBLOC LAME UNIE**  
BUTTER KNIFE, 1 PC SOLID HANDLE  
L 189 mm L 7 in<sup>7/16</sup>

### TYPE DROIT



**190018**  
**CUILLÈRE À SODA**  
ICED TEASPOON / LONGDRINK  
L 189 mm L 7 in<sup>7/16</sup>



**189973**  
**CUILLÈRE À SODA**  
ICED TEASPOON / LONGDRINK  
L 190 mm L 7 in<sup>1/2</sup>



**190424**  
**FOURCHETTE À HÙITRES**  
OYSTER / SHELLFISH FORK  
L 141 mm L 5 in<sup>9/16</sup>



**189974**  
**FOURCHETTE À HÙITRES**  
OYSTER / SHELLFISH FORK  
L 141 mm L 5 in<sup>9/16</sup>



**153193**  
**LOUCHE**  
SOUP LADLE  
L 297 mm L 11 in<sup>11/16</sup>



**231218**  
**FOURCHETTE DE SERVICE**  
SERVING FORK  
L 266 mm L 10 in<sup>1/2</sup>



**154606**  
**LOUCHE À SAUCE**  
SAUCE LADLE  
L 185 mm L 7 in<sup>5/16</sup>



**231219**  
**CUILLÈRE DE SERVICE**  
SERVING SPOON  
L 266 mm L 10 in<sup>1/2</sup>



**231221**  
**PELLE À TARTE**  
PASTRY SERVER, SOLID HANDLE  
L 252 mm L 9 in<sup>15/16</sup>



**231220**  
**LOUCHE**  
SOUP LADLE  
L 290 mm L 11 in<sup>7/16</sup>

### PETIT GOURMET



**207257**  
**FOURCHETTE À DESSERT**  
DESSERT FORK  
L 165 mm L 6 in<sup>1/2</sup>



**207258**  
**CUILLÈRE À DESSERT**  
DESSERT SPOON  
L 165 mm L 6 in<sup>1/2</sup>



**207259**  
**COUPEAU À DESSERT MONOBLOC LAME UNIE**  
DESSERT KNIFE SOLID HANDLE  
L 177 mm L 6 in<sup>15/16</sup>



**207256**  
**CUILLÈRE À CAFÉ**  
COFFEE SPOON  
L 132 mm L 5 in<sup>3/16</sup>





## LA VAISSELLE

Nos collections de vaisselle, comme nos iconiques L Fragment, L Couture ou nos Cocottes, sont imaginées pour magnifier chaque création culinaire. Dans nos Manufactures, à Limoges pour la porcelaine fine extra blanche et en Hongrie pour la porcelaine de couleur, nous travaillons les matières nobles et les lignes pures, en jouant sur les contrastes, les couleurs et les textures. Chaque pièce s'associe avec élégance pour composer des tables uniques, où la sobriété rencontre l'excellence. Dressées par les Chefs, pensées pour l'art de recevoir, nos assiettes incarnent la signature Guy Degrenne : l'élégance française au service du goût.

## DINNERWARE

*Our tableware collections, including our iconic L Fragment, L Couture, and our Cocottes, are designed to elevate every culinary creation. In our Manufactories—Limoges for extra-white fine porcelain and Hungary for coloured porcelain—we work with noble materials and pure lines, playing with contrasts, colours, and textures. Each piece combines gracefully to create unique tables where simplicity meets excellence. Styled by Chefs and conceived for the art of entertaining, our plates embody the Guy Degrenne signature: French elegance in the service of taste.*





LA PORCELAINE DE LIMOGES  
LIMOGES PORCELAIN

Symbole d'excellence et de raffinement, la Porcelaine de Limoges révèle une blancheur et une opalescence incomparables. Dans notre Manufacture, chaque pièce est façonnée avec une précision rare, pour offrir aux tables les plus exigeantes une élégance intemporelle. Découvrez les coulisses des savoir-faire de nos artisans, où tradition et modernité se rencontrent. Nos collections aux reliefs délicats comme L Fragment, L Couture, L Perles De Rosée ou la nouvelle L Rayon jouent sur les effets de textures, de mat et de brillant. Nos décors sur Galon, SD One ou Supernature sont peints à la main avec de l'or fin ou du platine.

*A symbol of excellence and refinement, Limoges porcelain reveals an incomparable whiteness and opalescence. In our Manufactory, each piece is crafted with exceptional precision to bring timeless elegance to the most demanding tables. Discover the behind-the-scenes expertise of our artisans, where tradition meets modernity. Our collections with delicate reliefs, such as L Fragment, L Couture, L Perles De Rosée, or the new L Rayon, play with textured effects, matte and glossy finishes. Our designs on Galon, SD One, or Supernature are hand-painted with fine gold or platinum. and glossy effects, or hand-painted decorations in fine gold or platinum.*

*g.d.*

COLLECTION L . . . . .	107
COLLECTION L COUTURE. . . . .	111
COLLECTION L FRAGMENT . . . . .	113
COLLECTION L FRAGMENT NOIR . . . . .	115
COLLECTION L PERLES DE ROSÉE . . . . .	117
<b>NEW</b> COLLECTION L RAYON. . . . .	119
<b>NEW</b> COLLECTION L RAYON NOIR . . . . .	121
ÉCLIPSE . . . . .	123
GALON OR . . . . .	125
GALON PLATINE . . . . .	129
<b>NEW</b> RÉMINISCENCE . . . . .	133
RÉMINISCENCE COULEUR . . . . .	135
SD ONE. . . . .	137
SUPERNATURE . . . . .	139



Découvrez les coulisses de notre Manufacture à Limoges  
*Discover our Manufactory in Limoges*



# COLLECTION L

MADE IN FRANCE



**227822**  
**ASSIETTE DE PRÉSENTATION**  
 PRESENTATION PLATE  
 Ø 32 cm Ø 12 in<sup>5/8</sup>  
 Ø INT : 19,5 cm 7 in<sup>11/16</sup>

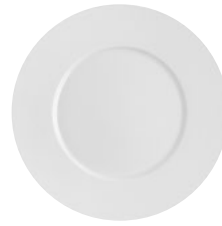

**227823**  
**ASSIETTE PLATE**  
 DINNER PLATE  
 Ø 28 cm Ø 11 in  
 Ø INT : 17 cm 6 in<sup>11/16</sup>



**227824**  
**ASSIETTE À DESSERT**  
 DESSERT PLATE  
 Ø 24 cm Ø 9 in<sup>7/16</sup>  
 Ø INT 15 cm Ø INT 5 in<sup>7/8</sup>



**227825**  
**ASSIETTE À PAIN**  
 BREAD AND BUTTER PLATE  
 Ø 14 cm Ø 5 in<sup>1/2</sup>  
 Ø INT : 9,5 cm 3 in<sup>3/4</sup>



**227826**  
**ASSIETTE GOURMET**  
**GRAND BASSIN**  
 GOURMET PLATE LARGE WELL  
 Ø 30 cm Ø 11 in<sup>13/16</sup>  
 Ø INT : 14 cm 5 in<sup>1/2</sup>

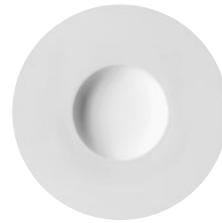

**227827**  
**ASSIETTE GOURMET**  
**PETIT BASSIN**  
 GOURMET PLATE SMALL WELL  
 Ø 27,9 cm Ø 11 in  
 Ø INT : 11,5 cm 4 in<sup>1/2</sup>



**227828**  
**TASSE À ESPRESSO**  
 ESPRESSO CUP  
 10 cl 3 oz<sup>3/8</sup>  
 H 6 cm H 2 in<sup>3/8</sup>  
 Ø 5,7 cm Ø 2 in<sup>1/4</sup>



**227829**  
**TASSE À THÉ / LUNGO**  
 TEA / LUNGO CUP  
 25 cl 8 oz<sup>7/16</sup>  
 H 6 cm H 2 in<sup>3/8</sup>  
 Ø 8,5 cm Ø 3 in<sup>3/8</sup>

**227831**  
**SOUCOUPE À ESPRESSO**  
 ESPRESSO SAUCER  
 Ø 12,6 cm Ø 4 in<sup>15/16</sup>

**227832**  
**SOUCOUPE À THÉ / LUNGO**  
 TEA / LUNGO SAUCER  
 Ø 15,8 cm Ø 6 in<sup>1/4</sup>



# COLLECTION L

MADE IN FRANCE



**227839**  
**PLAT À TARTE**  
 PIE DISH  
 Ø 31,5 cm    Ø 12 in<sup>3/8</sup>



**227840**  
**PLAT CREUX**  
 DEEP DISH  
 Ø 30,5 cm    Ø 12 in



**227837**  
**PLAT OVALE**  
 OVAL DISH  
 L 36,5 cm    L 14 in<sup>3/8</sup>  
 l 26,5 cm    W 10 in<sup>7/16</sup>



**227838**  
**PLAT À CAKE**  
 CAKE DISH  
 L 37 cm    L 14 in<sup>9/16</sup>  
 l 15 cm    W 5 in<sup>7/8</sup>



**227841**  
**SALADIER**  
 SERVING BOWL  
 Ø 25 cm    Ø 9 in<sup>13/16</sup>



**247814** **NEW**  
**BOL**  
 BOWL  
 H 7,5 cm    H 2 in<sup>15/16</sup>  
 Ø 19,5 cm    Ø 7 in<sup>11/16</sup>



**232576**  
**ASSIETTE CREUSE**  
 SOUP PLATE  
 Ø 18,5 cm    Ø 7 in<sup>5/16</sup>



**227842**  
**COUPELLE**  
 SMALL BOWL  
 Ø 13,5 cm    Ø 5 in<sup>5/16</sup>



**247813** **NEW**  
**PETIT PLATEAU**  
 SMALL TRAY  
 L 16 cm    L 6 in<sup>5/16</sup>  
 l 12 cm    W 4 in<sup>3/4</sup>



**247809** **NEW**  
**VIDE-POCHE**  
 CATCH-ALL TRAY  
 L 21,3 cm    L 8 in<sup>3/8</sup>  
 l 17,4 cm    W 6 in<sup>7/8</sup>



**227834**  
**THÉIÈRE**  
 TEA POT  
 100 cl    33 oz<sup>13/16</sup>  
 H 15,7 cm    H 6 in<sup>3/16</sup>  
 Ø 12,4 cm    Ø 4 in<sup>7/8</sup>



**227835**  
**CRÉMIER**  
 CREAM JUG  
 16 cl    5 oz<sup>7/16</sup>  
 H 8,5 cm    H 3 in<sup>3/8</sup>  
 Ø 6,7 cm    Ø 2 in<sup>5/8</sup>



**227836**  
**SUCRIER**  
 SUGAR BOWL  
 30 cl    10 oz<sup>1/8</sup>  
 H 10,8 cm    H 4 in<sup>1/4</sup>  
 Ø 9,2 cm    Ø 3 in<sup>5/8</sup>



**247590** **NEW**  
**MUG**  
 30 cl    10 oz<sup>1/8</sup>  
 H 9,5 cm    H 3 in<sup>3/4</sup>  
 Ø 7,5 cm    Ø 2 in<sup>15/16</sup>





# COLLECTION L COUTURE

MADE IN FRANCE



**237398**  
**ASSIETTE DE PRÉSENTATION**  
 PRESENTATION PLATE  
 Ø 32 cm    Ø 12 in<sup>5/8</sup>  
 Ø INT : 19,5 cm    7 in<sup>11/16</sup>



**237399**  
**ASSIETTE PLATE**  
 DINNER PLATE  
 Ø 28 cm    Ø 11 in  
 Ø INT : 17 cm    6 in<sup>11/16</sup>



**237400**  
**ASSIETTE À DESSERT**  
 DESSERT PLATE  
 Ø 24 cm    Ø 9 in<sup>7/16</sup>  
 Ø INT : 15 cm    5 in<sup>7/8</sup>



**237401**  
**ASSIETTE À PAIN**  
 BREAD AND BUTTER PLATE  
 Ø 14 cm    Ø 5 in<sup>1/2</sup>  
 Ø INT : 9,5 cm    3 in<sup>3/4</sup>



**237402**  
**ASSIETTE GOURMET**  
 GRAND BASSIN  
 GOURMET PLATE LARGE WELL  
 Ø 30 cm    Ø 11 in<sup>13/16</sup>  
 Ø INT : 14 cm    5 in<sup>1/2</sup>



**237403**  
**ASSIETTE GOURMET**  
 PETIT BASSIN  
 GOURMET PLATE SMALL WELL  
 Ø 27,9 cm    Ø 11 in  
 Ø INT : 11,5 cm    4 in<sup>1/2</sup>



**227828**  
**TASSE À ESPRESSO**  
 ESPRESSO CUP  
 10 cl    3 oz<sup>2/8</sup>  
 H 6 cm    H 2 in<sup>3/8</sup>  
 Ø 5,7 cm    Ø 2 in<sup>1/4</sup>



**227829**  
**TASSE À THÉ / LUNGO**  
 TEA / LUNGO CUP  
 25 cl    8 oz<sup>7/16</sup>  
 H 6 cm    H 2 in<sup>3/8</sup>  
 Ø 8,5 cm    Ø 3 in<sup>3/8</sup>

**237404**  
**SOUCOUPE À ESPRESSO**  
 ESPRESSO SAUCER  
 Ø 12,6 cm    Ø 4 in<sup>15/16</sup>

**237405**  
**SOUCOUPE À THÉ / LUNGO**  
 TEA / LUNGO SAUCER  
 Ø 15,8 cm    Ø 6 in<sup>1/4</sup>



# COLLECTION L FRAGMENT

MADE IN FRANCE



**227843**  
**ASSIETTE DE PRÉSENTATION**  
 PRESENTATION PLATE  
 Ø 32 cm Ø 12 in<sup>5/8</sup>  
 Ø INT : 19,5 cm 7 in<sup>11/16</sup>

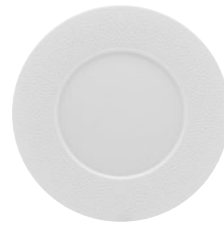

**227844**  
**ASSIETTE PLATE**  
 DINNER PLATE  
 Ø 28 cm Ø 11 in  
 Ø INT : 17 cm 6 in<sup>11/16</sup>



**227845**  
**ASSIETTE À DESSERT**  
 DESSERT PLATE  
 Ø 24 cm Ø 9 in<sup>7/16</sup>  
 Ø INT : 15 cm 5 in<sup>7/8</sup>



**227846**  
**ASSIETTE À PAIN**  
 BREAD AND BUTTER PLATE  
 Ø 14 cm Ø 5 in<sup>1/2</sup>  
 Ø INT : 9,5 cm 3 in<sup>3/4</sup>



**227847**  
**ASSIETTE GOURMET**  
 GRAND BASSIN  
 GOURMET PLATE LARGE WELL  
 Ø 30 cm Ø 11 in<sup>13/16</sup>  
 Ø INT : 14 cm 5 in<sup>1/2</sup>



**227848**  
**ASSIETTE GOURMET**  
 PETIT BASSIN  
 GOURMET PLATE SMALL WELL  
 Ø 27,9 cm Ø 11 in  
 Ø INT : 11,5 cm 4 in<sup>1/2</sup>



**227828**  
**TASSE À ESPRESSO**  
 ESPRESSO CUP  
 10 cl 3 oz<sup>3/8</sup>  
 H 6 cm H 2 in<sup>3/8</sup>  
 Ø 5,7 cm Ø 2 in<sup>1/4</sup>



**227829**  
**TASSE À THÉ / LUNGO**  
 TEA / LUNGO CUP  
 25 cl 8 oz<sup>7/16</sup>  
 H 6 cm H 2 in<sup>3/8</sup>  
 Ø 8,5 cm Ø 3 in<sup>3/8</sup>

**227849**  
**SOUCOUCPE À ESPRESSO**  
 ESPRESSO SAUCER  
 Ø 12,6 cm Ø 4 in<sup>15/16</sup>

**227850**  
**SOUCOUCPE À THÉ / LUNGO**  
 TEA / LUNGO SAUCER  
 Ø 15,8 cm Ø 6 in<sup>1/4</sup>



# COLLECTION L FRAGMENT NOIR

MADE IN FRANCE



**245599**  
ASSIETTE DE PRÉSENTATION  
PRESENTATION PLATE  
Ø 32 cm    Ø 12 in<sup>5/8</sup>  
Ø INT : 19,5 cm 7 in<sup>11/16</sup>



**245601**  
ASSIETTE PLATE  
DINNER PLATE  
Ø 28 cm    Ø 11 in  
Ø INT : 17 cm    6 in<sup>11/16</sup>



**245603**  
ASSIETTE À DESSERT  
DESSERT PLATE  
Ø 24 cm    Ø 9 in<sup>7/16</sup>  
Ø INT : 15 cm    5 in<sup>7/8</sup>



**247775** NEW  
SOUCOUBE À THÉ / ASSIETTE  
À PAIN  
TEA SAUCER / BREAD PLATE  
Ø 15,8 cm    Ø 6 in<sup>1/4</sup>  
Ø INT : 8 cm    3 in<sup>1/8</sup>



**245607**  
ASSIETTE GOURMET  
GRAND BASSIN  
GOURMET PLATE LARGE WELL  
Ø 30 cm    Ø 11 in<sup>13/16</sup>  
Ø INT : 14 cm    5 in<sup>1/2</sup>



# COLLECTION L PERLES DE ROSÉE

MADE IN FRANCE

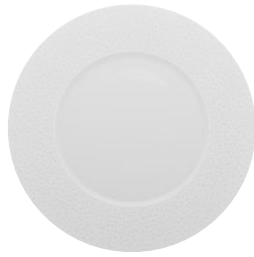

**233922**  
**ASSIETTE DE PRÉSENTATION**  
 PRESENTATION PLATE  
 Ø 32 cm    Ø 12 in<sup>5/8</sup>  
 Ø INT : 19,5 cm    7 in<sup>11/16</sup>

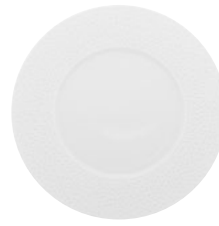

**233923**  
**ASSIETTE PLATE**  
 DINNER PLATE  
 Ø 28 cm    Ø 11 in  
 Ø INT : 17 cm    6 in<sup>11/16</sup>

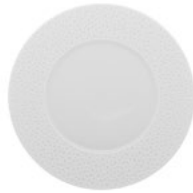

**233924**  
**ASSIETTE À DESSERT**  
 DESSERT PLATE  
 Ø 24 cm    Ø 9 in<sup>7/16</sup>  
 Ø INT : 15 cm    5 in<sup>7/8</sup>



**233925**  
**ASSIETTE À PAIN**  
 BREAD AND BUTTER PLATE  
 Ø 14 cm    Ø 5 in<sup>1/2</sup>  
 Ø INT : 9,5 cm    3 in<sup>3/4</sup>



**233926**  
**ASSIETTE GOURMET**  
 GRAND BASSIN  
 GOURMET PLATE LARGE WELL  
 Ø 30 cm    Ø 11 in<sup>13/16</sup>  
 Ø INT : 14 cm    5 in<sup>1/2</sup>



**233927**  
**ASSIETTE GOURMET**  
 PETIT BASSIN  
 GOURMET PLATE SMALL WELL  
 Ø 27,9 cm    Ø 11 in  
 Ø INT : 11,5 cm    4 in<sup>1/2</sup>



**227828**  
**TASSE À ESPRESSO**  
 ESPRESSO CUP  
 10 cl    3 oz<sup>2/8</sup>  
 H 6 cm    H 2 in<sup>3/8</sup>  
 Ø 5,7 cm    Ø 2 in<sup>1/4</sup>



**227829**  
**TASSE À THÉ / LUNGO**  
 TEA / LUNGO CUP  
 25 cl    8 oz<sup>7/16</sup>  
 H 6 cm    H 2 in<sup>3/8</sup>  
 Ø 8,5 cm    Ø 3 in<sup>3/8</sup>

**233928**  
**SOUCCOUE À ESPRESSO**  
 ESPRESSO SAUCER  
 Ø 12,6 cm    Ø 4 in<sup>15/16</sup>

**233929**  
**SOUCCOUE À THÉ / LUNGO**  
 TEA / LUNGO SAUCER  
 Ø 15,8 cm    Ø 6 in<sup>1/4</sup>





# COLLECTION L RAYON NEW

  
 MADE IN FRANCE



**247032**  
**ASSIETTE DE PRÉSENTATION**  
 PRESENTATION PLATE  
 Ø 32 cm    Ø 12 in<sup>5/8</sup>  
 Ø INT : 19,5 cm    7 in<sup>11/16</sup>



**247033**  
**ASSIETTE PLATE**  
 DINNER PLATE  
 Ø 27,9cm    Ø 11 in  
 Ø INT : 17 cm    6 in<sup>11/16</sup>



**247035**  
**ASSIETTE À DESSERT**  
 DESSERT PLATE  
 Ø 24 cm    Ø 9 in<sup>7/16</sup>  
 Ø INT : 15 cm    5 in<sup>7/8</sup>



**247038**  
**ASSIETTE À PAIN**  
 BREAD AND BUTTER PLATE  
 Ø 14 cm    Ø 5 in<sup>1/2</sup>  
 Ø INT : 9,5 cm    3 in<sup>3/4</sup>



**247036**  
**ASSIETTE GOURMET**  
 GRAND BASSIN  
 GOURMET PLATE LARGE WELL  
 Ø 30 cm    Ø 11 in<sup>13/16</sup>  
 Ø INT : 14 cm    5 in<sup>1/2</sup>



**247037**  
**ASSIETTE GOURMET**  
 PETIT BASSIN  
 GOURMET PLATE SMALL WELL  
 Ø 27,9 cm    Ø 11 in  
 Ø INT : 11,5 cm    4 in<sup>1/2</sup>



**247202**  
**ASSIETTE PLATE**  
 AILE PLUS PETITE  
 DINNER PLATE NARROW RIM  
 Ø 26,5 cm    Ø 10 in<sup>7/16</sup>  
 Ø INT : 17 cm    6 in<sup>11/16</sup>



**227828**  
**TASSE À ESPRESSO**  
 ESPRESSO CUP  
 10 cl    3 oz<sup>2/8</sup>  
 H 6 cm    H 2 in<sup>3/8</sup>  
 Ø 5,7 cm    Ø 2 in<sup>1/4</sup>



**227829**  
**TASSE À THÉ / LUNGO**  
 TEA / LUNGO CUP  
 25 cl    8 oz<sup>7/16</sup>  
 H 6 cm    H 2 in<sup>3/8</sup>  
 Ø 8,5 cm    Ø 3 in<sup>3/8</sup>

**247039**  
**SOUCOUPE À ESPRESSO**  
 ESPRESSO SAUCER  
 Ø 12,6 cm    Ø 4 in<sup>15/16</sup>

**247040**  
**SOUCOUPE À THÉ / LUNGO**  
 TEA / LUNGO SAUCER  
 Ø 15,8 cm    Ø 6 in<sup>1/4</sup>



# COLLECTION L RAYON NOIR NEW

MADE IN FRANCE



248544  
ASSIETTE DE PRÉSENTATION  
PRESENTATION PLATE  
Ø 32 cm    Ø 12 in<sup>5/8</sup>  
Ø INT : 19,5 cm    7 in<sup>13/16</sup>



248546  
ASSIETTE PLATE  
DINNER PLATE  
Ø 27,9 cm    Ø 11 in  
Ø INT : 17 cm    6 in<sup>13/16</sup>



248547  
ASSIETTE À DESSERT  
DESSERT PLATE  
Ø 24 cm    Ø 9 in<sup>7/16</sup>  
Ø INT : 15 cm    5 in<sup>7/8</sup>



248550  
ASSIETTE À PAIN  
BREAD AND BUTTER PLATE  
Ø 14 cm    Ø 5 in<sup>1/2</sup>  
Ø INT : 8,5 cm    3 in<sup>3/8</sup>



248548  
ASSIETTE GOURMET  
GRAND BASSIN  
GOURMET PLATE LARGE WELL  
Ø 30 cm    Ø 11 in<sup>13/16</sup>  
Ø INT : 14 cm    5 in<sup>1/2</sup>



# ÉCLIPSE

MADE IN FRANCE

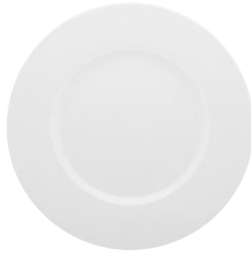

**235896**  
**ASSIETTE DE PRÉSENTATION**  
PRESENTATION PLATE  
Ø 32 cm    Ø 12 in<sup>5/8</sup>  
Ø INT : 19 cm    7 in<sup>1/2</sup>



**248943**  
**ASSIETTE PLATE**  
DINNER PLATE  
Ø 30 cm    Ø 11 in<sup>13/16</sup>  
Ø INT : 18 cm    7 in<sup>1/16</sup>

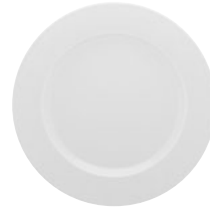

**235890**  
**ASSIETTE PLATE**  
DINNER PLATE  
Ø 26,5 cm    Ø 10 in<sup>7/16</sup>  
INT : 17 cm    6 in<sup>11/16</sup>



**235891**  
**ASSIETTE À DESSERT**  
DESSERT PLATE  
Ø 21,5 cm    Ø 8 in<sup>7/16</sup>  
Ø INT : 13 cm    5 in<sup>1/8</sup>



**248944**  
**ASSIETTE À PAIN**  
BREAD AND BUTTER PLATE  
Ø 16 cm    Ø 6 in<sup>5/16</sup>  
Ø INT : 10 cm    3 in<sup>15/16</sup>



**248946**  
**ASSIETTE CREUSE**  
SOUP PLATE  
Ø 22,5 cm    Ø 8 in<sup>7/8</sup>  
Ø INT : 13 cm    5 in<sup>1/8</sup>



**235892**  
**ASSIETTE CREUSE**  
SOUP PLATE  
Ø 19 cm    Ø 7 in<sup>1/2</sup>  
Ø INT : 12 cm    4 in<sup>3/4</sup>



**235902**  
**BOL**  
BOWL  
Ø 17,5 cm    Ø 6 in<sup>7/8</sup>



# GALON OR

PEINT À LA MAIN HAND PAINTED



**241089**  
**ASSIETTE DE PRÉSENTATION**  
PRESENTATION PLATE  
Ø 32 cm    Ø 12 in<sup>5/8</sup>  
Ø INT : 19 cm    7 in<sup>1/2</sup>



**241090**  
**ASSIETTE PLATE**  
DINNER PLATE  
Ø 26,5 cm    Ø 10 in<sup>7/16</sup>  
INT : 17 cm    6 in<sup>11/16</sup>



**241091**  
**ASSIETTE À DESSERT**  
DESSERT PLATE  
Ø 21,5 cm    Ø 8 in<sup>7/16</sup>  
Ø INT : 13 cm    5 in<sup>1/8</sup>



**227886**  
**ASSIETTE À PAIN**  
BREAD AND BUTTER PLATE  
Ø 14 cm    Ø 5 in<sup>1/2</sup>  
Ø INT : 10 cm    3 in<sup>15/16</sup>



**241097**  
**ASSIETTE CREUSE**  
SOUP PLATE  
Ø 22,5 cm    Ø 8 in<sup>7/8</sup>  
Ø INT : 13 cm    5 in<sup>1/8</sup>



**241092**  
**ASSIETTE CREUSE**  
SOUP PLATE  
Ø 19 cm    Ø 7 in<sup>1/2</sup>



**241099**  
**COUPELLE**  
SMALL BOWL  
38 cl    12 oz<sup>7/8</sup>  
Ø 13,5 cm    Ø 5 in<sup>5/16</sup>



**241098**  
**SALADIER**  
SERVING BOWL  
355 cl    120 oz<sup>1/16</sup>  
Ø 26 cm    Ø 10 in<sup>1/4</sup>





# GALON OR

PEINT À LA MAIN HAND PAINTED



**241096**  
**PLAT À TARTE**  
PIE DISH  
Ø 31,5 cm    Ø 12 in<sup>3/8</sup>



**241095**  
**PLAT OVALE**  
OVAL DISH  
L 36,5 cm    L 14 in<sup>3/8</sup>  
L 26,5 cm    W 10 in<sup>7/16</sup>



**241093**  
**TASSE À ESPRESSO**  
ESPRESSO CUP  
10 cl            3 oz<sup>2/8</sup>  
H 6 cm        H 2 in<sup>3/8</sup>  
Ø 5,5 cm      Ø 2 in<sup>3/16</sup>



**247598**  
**TASSE À THÉ / LUNGO**  
TEA / LUNGO CUP  
25 cl            8 oz<sup>7/16</sup>  
H 6 cm        H 2 in<sup>3/8</sup>  
Ø 8,5 cm      Ø 3 in<sup>3/8</sup>



**241102**  
**TASSE À DÉJEUNER**  
BREAKFAST CUP  
34 cl            11 oz<sup>1/2</sup>  
H 7 cm        H 2 in<sup>3/4</sup>  
Ø 9,8 cm      Ø 3 in<sup>7/8</sup>

**241094**  
**SOUCOUPE À ESPRESSO**  
ESPRESSO SAUCER  
Ø 12,5 cm    Ø 4 in<sup>15/16</sup>

**241105**  
**SOUCOUPE À THÉ / LUNGO**  
TEA / LUNGO SAUCER  
Ø 15 cm      Ø 5 in<sup>7/8</sup>

**241103**  
**SOUCOUPE À DÉJEUNER**  
BREAKFAST SAUCER  
Ø 19 cm      Ø 7 in<sup>1/2</sup>



**241100**  
**THÉIÈRE**  
TEA POT  
100 cl            33 oz<sup>13/16</sup>  
H 15,7 cm    H 6 in<sup>3/16</sup>  
Ø 12,4 cm    Ø 4 in<sup>7/8</sup>



**241101**  
**SUCRIER**  
SUGAR BOWL  
15 cl            5 oz<sup>1/16</sup>  
H 10,8 cm    H 4 in<sup>1/4</sup>





# GALON PLATINE

PEINT À LA MAIN HAND PAINTED



**190054**  
**ASSIETTE DE PRÉSENTATION**  
PRESENTATION PLATE  
Ø 32 cm    Ø 12 in<sup>5/8</sup>  
Ø INT : 19 cm    7 in<sup>1/2</sup>



**190050**  
**ASSIETTE PLATE**  
DINNER PLATE  
Ø 26,5 cm    Ø 10 in<sup>7/16</sup>  
INT : 17 cm    6 in<sup>11/16</sup>



**190051**  
**ASSIETTE À DESSERT**  
DESSERT PLATE  
Ø 21,5 cm    Ø 8 in<sup>7/16</sup>  
Ø INT : 13 cm    5 in<sup>1/8</sup>



**227777** **NEW**  
**ASSIETTE À PAIN**  
BREAD AND BUTTER PLATE  
Ø 14 cm    Ø 5 in<sup>1/2</sup>  
Ø INT : 10 cm    3 in<sup>15/16</sup>



**190053**  
**ASSIETTE CREUSE**  
SOUP PLATE  
Ø 22,5 cm    Ø 8 in<sup>7/8</sup>  
Ø INT : 13 cm    5 in<sup>1/8</sup>



**190052**  
**ASSIETTE CREUSE**  
SOUP PLATE  
Ø 19 cm    Ø 7 in<sup>1/2</sup>



**190070**  
**COUPELLE**  
SMALL BOWL  
38 cl    12 oz<sup>7/8</sup>  
Ø 13,5 cm    Ø 5 in<sup>5/16</sup>



**190071**  
**SALADIER**  
SERVING BOWL  
355 cl    120 oz<sup>1/16</sup>  
Ø 26 cm    Ø 10 in<sup>1/4</sup>



# GALON PLATINE

PEINT À LA MAIN HAND PAINTED



**190068**  
**PLAT À TARTE**  
PIE DISH  
Ø 31,5 cm    Ø 12 in<sup>3/8</sup>



**190069**  
**PLAT OVALE**  
OVAL DISH  
L 36,5 cm    L 14 in<sup>3/8</sup>  
l 26,5 cm    W 10 in<sup>7/16</sup>



**203238**  
**TASSE À ESPRESSO**  
ESPRESSO CUP  
10 cl    3 oz<sup>2/8</sup>  
H 6 cm    H 2 in<sup>3/8</sup>  
Ø 5,5 cm    Ø 2 in<sup>3/16</sup>



**247600**  
**TASSE À THÉ / LUNGO**  
TEA / LUNGO CUP  
25 cl    8 oz<sup>7/16</sup>  
H 6 cm    H 2 in<sup>3/8</sup>  
Ø 8,5 cm    Ø 3 in<sup>3/8</sup>



**203242**  
**TASSE À DÉJEUNER**  
BREAKFAST CUP  
34 cl    11 oz<sup>1/2</sup>  
H 7 cm    H 2 in<sup>3/4</sup>  
Ø 9,8 cm    Ø 3 in<sup>7/8</sup>

**203239**  
**SOUCOUPE À ESPRESSO**  
ESPRESSO SAUCER  
Ø 12,5 cm    Ø 4 in<sup>15/16</sup>

**203241**  
**SOUCOUPE À THÉ / LUNGO**  
TEA / LUNGO SAUCER  
Ø 15 cm    Ø 5 in<sup>7/8</sup>

**203243**  
**SOUCOUPE À DÉJEUNER**  
BREAKFAST SAUCER  
Ø 18 cm    Ø 7 in<sup>1/16</sup>



**203245**  
**THÉIÈRE**  
TEA POT  
100 cl    33 oz<sup>13/16</sup>  
H 15,7 cm    H 6 in<sup>3/16</sup>  
Ø 12,4 cm    Ø 4 in<sup>7/8</sup>



**203250**  
**SUCRIER**  
SUGAR BOWL  
15 cl    5 oz<sup>1/16</sup>  
H 10,8 cm    H 4 in<sup>1/4</sup>  
Ø 9,2 cm    Ø 3 in<sup>5/8</sup>





# RÉMINISCENCE

MADE IN FRANCE



**247158**  
**ASSIETTE DE PRÉSENTATION**  
 PRESENTATION PLATE  
 Ø 29,5 cm    Ø 11 in<sup>5/8</sup>  
 Ø INT : 20,5 cm    8 in<sup>1/16</sup>



**247157**  
**ASSIETTE PLATE**  
 DINNER PLATE  
 Ø 26 cm    Ø 10 in<sup>1/4</sup>  
 Ø INT : 17 cm    6 in<sup>11/16</sup>



**247163**  
**ASSIETTE À DESSERT**  
 DESSERT PLATE  
 Ø 21,5 cm    Ø 8 in<sup>7/16</sup>  
 Ø INT : 15 cm    5 in<sup>7/8</sup>



**247160 NEW**  
**ASSIETTE À PAIN**  
 BREAD AND BUTTER PLATE  
 Ø 14 cm    Ø 5 in<sup>1/2</sup>  
 Ø INT : 8,5 cm    3 in<sup>2/8</sup>



**247164**  
**ASSIETTE CREUSE**  
 SOUP PLATE  
 Ø 19 cm    Ø 7 in<sup>1/2</sup>  
 Ø INT : 12 cm    4 in<sup>3/4</sup>



**247159**  
**ASSIETTE À PÂTES**  
 PASTA PLATE  
 Ø 31,5 cm    Ø 12 in<sup>3/8</sup>  
 Ø INT : 21 cm    8 in<sup>1/4</sup>



**247161 NEW**  
**PLAT OVALE**  
 OVAL DISH  
 L 21,5 cm    L 8 in<sup>7/16</sup>  
 l 12,5 cm    W 4 in<sup>15/16</sup>



**247162 NEW**  
**SAUCIÈRE**  
 SAUCE BOAT  
 40 cl    13 oz<sup>1/2</sup>





# RÉMINISCENCE COULEUR

PEINT À LA MAIN HAND PAINTED



## VERT - GREEN



244172  
ASSIETTE  
PLATE  
Ø 26 cm    Ø 10 in<sup>1/4</sup>  
Ø INT : 17 cm    6 in<sup>11/16</sup>



244791  
ASSIETTE  
DESSERT PLATE  
Ø 21,5 cm    Ø 8 in<sup>7/16</sup>  
Ø INT : 15 cm    5 in<sup>7/8</sup>



244174  
ASSIETTE COUPE  
COUPE PLATE  
Ø 19 cm    Ø 7 in<sup>1/2</sup>

## ORANGE - ORANGE



244788  
ASSIETTE  
PLATE  
Ø 26 cm    Ø 10 in<sup>1/4</sup>  
Ø INT : 17 cm    6 in<sup>11/16</sup>



244792  
ASSIETTE À DESSERT  
DESSERT PLATE  
Ø 21,5 cm    Ø 8 in<sup>7/16</sup>  
Ø INT : 15 cm    5 in<sup>7/8</sup>

## JAUNE - YELLOW



244790  
ASSIETTE  
PLATE  
Ø 26 cm    Ø 10 in<sup>1/4</sup>  
Ø INT : 17 cm    6 in<sup>11/16</sup>



244794  
ASSIETTE À DESSERT  
DESSERT PLATE  
Ø 21,5 cm    Ø 8 in<sup>7/16</sup>  
Ø INT : 15 cm    5 in<sup>7/8</sup>



# SD ONE

MADE IN FRANCE

## BLANC - WHITE



**241052**  
ASSIETTE DE PRÉSENTATION  
PRESENTATION PLATE  
Ø 32 cm    Ø 12 in<sup>5/8</sup>



**241050**  
ASSIETTE PLATE  
DINNER PLATE  
Ø 27 cm    Ø 10 in<sup>5/8</sup>



**241051**  
ASSIETTE À DESSERT  
DESSERT PLATE  
Ø 21,5 cm    Ø 8 in<sup>7/16</sup>



**242916**  
ASSIETTE À PAIN  
BREAD AND BUTTER PLATE  
Ø 14 cm    Ø 5 in<sup>1/2</sup>



**241048**  
ASSIETTE CREUSE  
SOUP PLATE  
H 5 cm    H 1 in<sup>15/16</sup>  
Ø 25 cm    Ø 9 in<sup>13/16</sup>



**241049**  
ASSIETTE CREUSE  
SOUP PLATE  
H 4 cm    H 1 in<sup>9/16</sup>  
Ø 19 cm    Ø 7 in<sup>1/2</sup>



**241143**  
BOL  
BOWL  
55 cl    18 oz<sup>5/8</sup>  
Ø 14 cm    Ø 5 in<sup>1/2</sup>



**242910**  
TASSE À ESPRESSO  
ESPRESSO CUP  
7 cl    2 oz<sup>3/8</sup>  
H 6,3 cm    H 2 in<sup>1/2</sup>  
Ø 6 cm    Ø 2 in<sup>3/8</sup>



**242912**  
TASSE À THÉ / LUNGO  
TEA / LUNGO CUP  
15 cl    5 oz<sup>1/16</sup>  
H 8 cm    H 3 in<sup>1/8</sup>  
Ø 7,8 cm    Ø 3 in<sup>1/16</sup>



**245885**  
VERSEUSE  
COFFEE / TEA POT  
13 cl    4 oz<sup>3/8</sup>  
H 10,6 cm    H 4 in<sup>3/16</sup>



**247370** NEW  
PLAT OVALE  
OVAL DISH  
L 37 cm    L 14 in<sup>9/16</sup>  
l 27 cm    W 10 in<sup>5/8</sup>

**242914**  
SOUCOUPE  
SAUCER  
Ø 14 cm    Ø 5 in<sup>1/2</sup>

**242914**  
SOUCOUPE  
SAUCER  
Ø 14 cm    Ø 5 in<sup>1/2</sup>

## OR - GOLD PEINT À LA MAIN



**242547**  
ASSIETTE DE PRÉSENTATION  
PRESENTATION PLATE  
Ø 32 cm    Ø 12 in<sup>5/8</sup>



**241053**  
ASSIETTE PLATE  
DINNER PLATE  
Ø 27 cm    Ø 10 in<sup>5/8</sup>



**241054**  
ASSIETTE À DESSERT  
DESSERT PLATE  
Ø 21,5 cm    Ø 8 in<sup>7/16</sup>





# SUPERNATURE



## BLANC WHITE



242906  
ASSIETTE DE PRÉSENTATION  
PRESENTATION PLATE  
Ø 32 cm    Ø 12 in<sup>5/8</sup>



242330  
ASSIETTE PLATE  
DINNER PLATE  
Ø 27 cm    Ø 10 in<sup>5/8</sup>



242331  
ASSIETTE À DESSERT  
DESSERT PLATE  
Ø 21,5 cm    Ø 8 in<sup>7/16</sup>



242907  
ASSIETTE À PAIN  
BREAD AND BUTTER PLATE  
Ø 14 cm    Ø 5 in<sup>1/2</sup>

## OR GOLD PEINT À LA MAIN



248527 **NEW**  
ASSIETTE DE PRÉSENTATION  
PRESENTATION PLATE  
Ø 32 cm    Ø 12 in<sup>5/8</sup>



244121  
ASSIETTE PLATE  
DINNER PLATE  
Ø 27 cm    Ø 10 in<sup>5/8</sup>



244120  
ASSIETTE À DESSERT  
DESSERT PLATE  
Ø 21,5 cm    Ø 8 in<sup>7/16</sup>



248646 **NEW**  
ASSIETTE À PAIN  
BREAD AND BUTTER PLATE  
Ø 14cm    Ø 5 in<sup>1/2</sup>





## LA CÉRAMIQUE CERAMIC

En porcelaine ou en grès aux couleurs teintées dans la masse, nos collections comme Bahia et nos iconiques Cocottes célèbrent la richesse des matières et des gestes. Réalisées dans notre Manufacture en Hongrie, nos pièces expriment l'expertise de nos artisans et la créativité de nos designers. Formats variés, descentes profondes, couleurs subtiles, jeux de finitions et de textures : nos créations s'adaptent à vos tables pour une mise en scène élégante et chaleureuse.

*In porcelain or stoneware with colors tinted throughout the material, our collections such as Bahia and our iconic Cocottes celebrate the richness of materials and craftsmanship. Made in our Manufacture in Hungary, each piece reflects the expertise of our artisans and the creativity of our designers. Varied formats, deep curves, subtle colors, and a play of finishes and textures: our creations adapt to your tables for an elegant and inviting presentation. elegant and warm presentations.*

BAHIA & COCOTTES ONYX . . . . .	143
BAHIA PIERRE DE LUNE . . . . .	144
COCOTTES BLANC SABLE . . . . .	145
COCOTTES BLANC . . . . .	145
BAHIA & COCOTTES DUNE . . . . .	146
BAHIA & COCOTTES BLEU DE ROCHE . . . . .	147
BAHIA & COCOTTES ARGILE VERTE . . . . .	148
COCOTTES BLEU GOURMET . . . . .	149
COCOTTES ROSE NUDE . . . . .	149
BLUE SHADES . . . . .	151
BORÉAL . . . . .	153
BORÉAL ONDE . . . . .	155
BORÉAL SATIN . . . . .	157
BRUME . . . . .	159
COURONNE DORÉE . . . . .	161
COURONNE ARGENTÉE . . . . .	163
<b>NEW</b> ÉCLATS . . . . .	165
GRAPHIQUE . . . . .	167
GRAPHIQUE DORÉ . . . . .	169
LA VAISSELLE DE L'ÉCONOME . . . . .	171
MODULO . . . . .	173
MODULO NATURE PIERRE DE LAVE . . . . .	177
MODULO NATURE KAOLIN . . . . .	178
MODULO NATURE TERRE D'OMBRE . . . . .	179
MODULO NATURE BLEU GALET . . . . .	180
MODULO NATURE JADE . . . . .	181
RIVAGE . . . . .	183





# BAHIA & COCOTTES

MADE IN EUROPE

**ONYX - BLACK ONYX**  
GRÈS - STONEWARE



**236549**  
**ASSIETTE DE PRÉSENTATION**  
PRESENTATION PLATE  
Ø 29 cm    Ø 11 in<sup>7/16</sup>  
Ø INT : 25,5 cm 10 in<sup>1/16</sup>



**236548**  
**ASSIETTE PLATE**  
DINNER PLATE  
Ø 26 cm    Ø 10 in<sup>1/4</sup>  
Ø INT : 22 cm    8 in<sup>3/16</sup>



**236547**  
**ASSIETTE À DESSERT**  
DESSERT PLATE  
Ø 23 cm    Ø 9 in<sup>1/16</sup>  
Ø INT : 19,5 cm 7 in<sup>11/16</sup>



**236546**  
**ASSIETTE À PAIN**  
BREAD AND BUTTER PLATE  
Ø 14 cm    Ø 5 in<sup>1/2</sup>  
Ø INT : 10 cm    3 in<sup>5/16</sup>



**236551**  
**ASSIETTE GOURMET**  
PETIT BASSIN  
GOURMET PLATE SMALL WELL  
Ø 23 cm    Ø 9 in<sup>1/16</sup>  
Ø INT : 11,5 cm 4 in<sup>3/4</sup>



**236550**  
**ASSIETTE CREUSE**  
SOUP PLATE  
Ø 20 cm    Ø 7 in<sup>7/8</sup>  
Ø INT : 16,5 cm 6 in<sup>1/2</sup>



**243803**  
**COCOTTE**  
DEEP PLATE / CUP  
140 cl    47 oz<sup>5/16</sup>  
Ø 17,5 cm    Ø 6 in<sup>7/8</sup>



**236555**  
**COCOTTE**  
DEEP PLATE / CUP  
50 cl    16 oz<sup>2/5</sup>  
Ø 14 cm    Ø 5 in<sup>1/2</sup>



**243821**  
**ASSIETTE COCOTTE**  
SHALLOW PLATE / CUP  
100 cl    33 oz<sup>2/16</sup>  
Ø 22 cm    Ø 8 in<sup>11/16</sup>



**243830**  
**ASSIETTE COCOTTE**  
SHALLOW PLATE / CUP  
70 cl    23 oz<sup>11/16</sup>  
Ø 18 cm    Ø 7 in<sup>1/16</sup>

**236556**  
**ASSIETTE COUVERCLE**  
PLATE CUP / LID  
Ø 12,5 cm    Ø 4 in<sup>15/16</sup>



**236554**  
**COCOTTE BISEAUTÉE**  
SLANDED PLATE/CUP  
30 cl    10 oz<sup>1/8</sup>  
Ø 12 cm    Ø 4 in<sup>3/4</sup>



**236553**  
**MINI COCOTTE BISEAUTÉE**  
SLANDED PLATE/CUP  
7 cl    2 oz<sup>3/8</sup>  
Ø 7,3 cm    Ø 2 in<sup>7/8</sup>



**237206**  
**PLANCHE**  
BOARD  
L 25 cm    L 9 in<sup>13/16</sup>  
l 13,5 cm    W 5 in<sup>5/16</sup>



SUITE DE LA COLLECTION SUR LA PAGE SUIVANTE  
THE COLLECTION CONTINUES ON THE NEXT PAGE

**PIERRE DE LUNE - MOONSTONE**  
PORCELAINE - PORCELAIN



**239318**  
**ASSIETTE DE PRÉSENTATION**  
PRESENTATION PLATE  
Ø 29 cm    Ø 11 in<sup>7/16</sup>  
Ø INT : 25,5 cm 10 in<sup>1/16</sup>



**239317**  
**ASSIETTE PLATE**  
DINNER PLATE  
Ø 26 cm    Ø 10 in<sup>1/4</sup>  
Ø INT : 22 cm    8 in<sup>11/16</sup>



**239316**  
**ASSIETTE À DESSERT**  
DESSERT PLATE  
Ø 23 cm    Ø 9 in<sup>11/16</sup>  
Ø INT : 19,5 cm 7 in<sup>11/16</sup>



**239315**  
**ASSIETTE À PAIN**  
BREAD AND BUTTER PLATE  
Ø 14 cm    Ø 5 in<sup>1/2</sup>  
Ø INT : 10 cm    3 in<sup>15/16</sup>



**239321**  
**ASSIETTE GOURMET**  
**GRAND BASSIN**  
GOURMET PLATE LARGE WELL  
Ø 26 cm    Ø 10 in<sup>1/4</sup>  
Ø INT : 14 cm    5 in<sup>1/2</sup>



**239320**  
**ASSIETTE GOURMET**  
**PETIT BASSIN**  
GOURMET PLATE SMALL WELL  
Ø 23 cm    Ø 9 in<sup>11/16</sup>  
Ø INT : 11,5 cm 4 in<sup>3/4</sup>



**239319**  
**ASSIETTE CREUSE**  
SOUP PLATE  
Ø 20 cm    Ø 7 in<sup>7/8</sup>  
Ø INT : 16,5 cm 6 in<sup>1/2</sup>



**239325**  
**SALADIER**  
SERVING BOWL  
400 cl    135 oz<sup>1/4</sup>  
Ø 28 cm    Ø 11 in



**242055**  
**PLANCHE RONDE**  
ROUND BOARD  
Ø 29 cm    Ø 11 in<sup>7/16</sup>



**242054**  
**PLANCHE**  
BOARD  
L 35 cm    L 13 in<sup>3/4</sup>  
L 21 cm    W 8 in<sup>1/4</sup>



**PLATS À FOUR**  
BAKING DISHES

**241833**  
L 15,5 cm    L 6 in<sup>1/8</sup>  
H 4,4 cm    H 1 in<sup>3/4</sup>  
l 10,7 cm    W 4 in<sup>3/16</sup>

**241834**  
L 22,8 cm    L 9 in  
H 5,4 cm    H 2 in<sup>1/8</sup>  
l 16,2 cm    W 6 in<sup>3/8</sup>

# COCOTTES



## BLANC SABLE - SANDY WHITE



**234344**  
**COCOTTE**  
DEEP PLATE / CUP  
**140 cl** 47 oz<sup>5/16</sup>  
**H 6,8 cm** H 2 in<sup>11/16</sup>  
**Ø 17,5 cm** Ø 6 in<sup>7/8</sup>

**245378**  
**ASSIETTE COUVERCLE**  
PLATE CUP / LID  
**Ø 18 cm** Ø 7 in<sup>1/16</sup>



**209720**  
**COCOTTE**  
DEEP PLATE / CUP  
**50 cl** 16 oz<sup>15/16</sup>  
**Ø 14 cm** Ø 5 in<sup>1/2</sup>

**209384**  
**ASSIETTE COUVERCLE**  
PLATE CUP / LID  
**Ø 12,5 cm** Ø 4 in<sup>15/16</sup>



**234345**  
**ASSIETTE COCOTTE**  
SHALLOW PLATE / CUP  
**100 cl** 33 oz<sup>13/16</sup>  
**H 4 cm** H 1 in<sup>9/16</sup>  
**Ø 22 cm** Ø 8 in<sup>11/16</sup>



**235065**  
**ASSIETTE COCOTTE**  
SHALLOW PLATE / CUP  
**70 cl** 23 oz<sup>11/16</sup>  
**H 3,5 cm** H 1 in<sup>3/8</sup>  
**Ø 18 cm** Ø 7 in<sup>1/16</sup>



**234343**  
**COCOTTE BISEAUTÉE**  
SLANDED PLATE/CUP  
**100 cl** 33 oz<sup>13/16</sup>  
**Ø 16 cm** Ø 6 in<sup>5/16</sup>



**211893**  
**COCOTTE BISEAUTÉE**  
SLANDED PLATE/CUP  
**30 cl** 10 oz<sup>1/8</sup>  
**Ø 12 cm** Ø 4 in<sup>3/4</sup>



**211892**  
**MINI COCOTTE BISEAUTÉE**  
SLANDED PLATE/CUP  
**7 cl** 2 oz<sup>3/8</sup>  
**Ø 7,3 cm** Ø 2 in<sup>7/8</sup>

## BLANC - WHITE



**234341**  
**COCOTTE**  
DEEP PLATE / CUP  
**140 cl** 47 oz<sup>5/16</sup>  
**H 6,8 cm** H 2 in<sup>11/16</sup>  
**Ø 17,5 cm** Ø 6 in<sup>7/8</sup>

**245378**  
**ASSIETTE COUVERCLE**  
PLATE CUP / LID  
**Ø 18 cm** Ø 7 in<sup>1/16</sup>



**209383**  
**COCOTTE**  
DEEP PLATE / CUP  
**50 cl** 16 oz<sup>15/16</sup>  
**Ø 14 cm** Ø 5 in<sup>1/2</sup>

**209384**  
**ASSIETTE COUVERCLE**  
PLATE CUP / LID  
**Ø 12,5 cm** Ø 4 in<sup>15/16</sup>



**234342**  
**ASSIETTE COCOTTE**  
SHALLOW PLATE / CUP  
**100 cl** 33 oz<sup>13/16</sup>  
**H 4 cm** H 1 in<sup>9/16</sup>  
**Ø 22 cm** Ø 8 in<sup>11/16</sup>



**235064**  
**ASSIETTE COCOTTE**  
SHALLOW PLATE / CUP  
**70 cl** 23 oz<sup>11/16</sup>  
**H 3,5 cm** H 1 in<sup>3/8</sup>  
**Ø 18 cm** Ø 7 in<sup>1/16</sup>



**234340**  
**COCOTTE BISEAUTÉE**  
SLANDED PLATE/CUP  
**100 cl** 33 oz<sup>13/16</sup>  
**Ø 16 cm** Ø 6 in<sup>5/16</sup>



**186849**  
**COCOTTE BISEAUTÉE**  
SLANDED PLATE/CUP  
**30 cl** 10 oz<sup>1/8</sup>  
**Ø 12 cm** Ø 4 in<sup>3/4</sup>



**211891**  
**MINI COCOTTE BISEAUTÉE**  
SLANDED PLATE/CUP  
**7 cl** 2 oz<sup>3/8</sup>  
**Ø 7,3 cm** Ø 2 in<sup>7/8</sup>



SUITE DE LA COLLECTION SUR LA PAGE SUIVANTE  
THE COLLECTION CONTINUES ON THE NEXT PAGE

# BAHIA & COCOTTES

MADE IN EUROPE

DUNE - BEIGE DUNE  
GRÈS - STONEWARE



**230921**  
**ASSIETTE DE PRÉSENTATION**  
PRESENTATION PLATE  
Ø 29 cm Ø 11 in<sup>7/16</sup>  
Ø INT : 25,5 cm 10 in<sup>1/16</sup>



**230920**  
**ASSIETTE PLATE**  
DINNER PLATE  
Ø 26 cm Ø 10 in<sup>1/4</sup>  
Ø INT : 22 cm 8 in<sup>11/16</sup>



**230919**  
**ASSIETTE À DESSERT**  
DESSERT PLATE  
Ø 23 cm Ø 9 in<sup>1/16</sup>  
Ø INT : 19,5 cm 7 in<sup>11/16</sup>



**230924**  
**ASSIETTE GOURMET**  
GRAND BASSIN  
GOURMET PLATE LARGE WELL  
Ø 26 cm Ø 10 in<sup>1/4</sup>  
Ø INT : 14 cm 5 in<sup>1/2</sup>



**230923**  
**ASSIETTE GOURMET**  
PETIT BASSIN  
GOURMET PLATE SMALL WELL  
Ø 23 cm Ø 9 in<sup>1/16</sup>  
Ø INT : 11,5 cm 4 in<sup>3/4</sup>



**230922**  
**ASSIETTE CREUSE**  
SOUP PLATE  
Ø 20 cm Ø 7 in<sup>7/8</sup>  
Ø INT : 16,5 cm 6 in<sup>1/2</sup>



**235223**  
**SALADIER**  
SERVING BOWL  
400 cl 135 oz<sup>1/4</sup>  
Ø 28 cm Ø 11 in



**243797**  
**COCOTTE**  
DEEP PLATE / CUP  
140 cl 47 oz<sup>5/16</sup>  
Ø 17,5 cm Ø 6 in<sup>7/8</sup>



**230927**  
**COCOTTE**  
DEEP PLATE / CUP  
50 cl 16 oz<sup>15/16</sup>  
Ø 14 cm Ø 5 in<sup>1/2</sup>



**243824**  
**ASSIETTE COCOTTE**  
SHALLOW PLATE / CUP  
70 cl 23 oz<sup>11/16</sup>  
Ø 18 cm Ø 7 in<sup>1/16</sup>

**230928**  
**ASSIETTE COUVERCLE**  
PLATE CUP / LID  
Ø 12,5 cm Ø 4 in<sup>15/16</sup>



**230926**  
**COCOTTE BISEAUTÉE**  
SLANDED PLATE / CUP  
30 cl 10 oz<sup>1/8</sup>  
Ø 12 cm Ø 4 in<sup>3/4</sup>



**230925**  
**MINI COCOTTE BISEAUTÉE**  
SLANDED PLATE / CUP  
7 cl 2 oz<sup>3/8</sup>  
Ø 7,3 cm Ø 2 in<sup>7/8</sup>



**242057**  
**PLANCHE RONDE**  
ROUND BOARD  
Ø 29 cm Ø 11 in<sup>7/16</sup>



**242056**  
**PLANCHE**  
BOARD  
L 35 cm L 13 in<sup>3/4</sup>  
l 21 cm W 8 in<sup>1/4</sup>



**234948**  
**PLANCHE**  
BOARD  
L 25 cm L 9 in<sup>13/16</sup>  
l 13,5 cm W 5 in<sup>5/16</sup>



# BAHIA & COCOTTES

MADE IN EUROPE

BLEU DE ROCHE - BLUE STONE  
GRÈS - STONEWARE



**230966**  
**ASSIETTE DE PRÉSENTATION**  
PRESENTATION PLATE  
Ø 29 cm Ø 11 in<sup>7/16</sup>  
Ø INT : 25,5 cm 10 in<sup>1/16</sup>



**230965**  
**ASSIETTE PLATE**  
DINNER PLATE  
Ø 26 cm Ø 10 in<sup>1/4</sup>  
Ø INT : 22 cm 8 in<sup>1/16</sup>



**230964**  
**ASSIETTE À DESSERT**  
DESSERT PLATE  
Ø 23 cm Ø 9 in<sup>1/16</sup>  
Ø INT : 19,5 cm 7 in<sup>1/16</sup>



**230963**  
**ASSIETTE À PAIN**  
BREAD AND BUTTER PLATE  
Ø 14 cm Ø 5 in<sup>1/2</sup>  
Ø INT : 10 cm 3 in<sup>5/16</sup>



**230969**  
**ASSIETTE GOURMET**  
GRAND BASSIN  
GOURMET PLATE LARGE WELL  
Ø 26 cm Ø 10 in<sup>1/16</sup>  
Ø INT : 14 cm 5 in<sup>1/2</sup>



**230968**  
**ASSIETTE GOURMET**  
PETIT BASSIN  
GOURMET PLATE SMALL WELL  
Ø 23 cm Ø 9 in<sup>1/16</sup>  
Ø INT : 11,5 cm 4 in<sup>3/4</sup>



**230967**  
**ASSIETTE CREUSE**  
SOUP PLATE  
Ø 20 cm Ø 7 in<sup>7/8</sup>  
Ø INT : 16,5 cm 6 in<sup>1/2</sup>



**235222**  
**SALADIER**  
SERVING BOWL  
400 cl 135 oz<sup>1/16</sup>  
Ø 28 cm Ø 11 in



**243800**  
**COCOTTE**  
DEEP PLATE / CUP  
140 cl 47 oz<sup>5/16</sup>  
H 6,8 cm H 2 in<sup>11/16</sup>  
Ø 17,5 cm Ø 6 in<sup>7/8</sup>



**230972**  
**COCOTTE**  
DEEP PLATE / CUP  
50 cl 16 oz<sup>15/16</sup>  
Ø 14 cm Ø 5 in<sup>1/2</sup>



**243818**  
**ASSIETTE COCOTTE**  
SHALLOW PLATE / CUP  
100 cl 33 oz<sup>13/16</sup>  
Ø 22 cm Ø 8 in<sup>11/16</sup>



**243827**  
**ASSIETTE COCOTTE**  
SHALLOW PLATE / CUP  
70 cl 23 oz<sup>1/16</sup>  
Ø 18 cm Ø 7 in<sup>3/16</sup>

**230973**  
**ASSIETTE COUVERCLE**  
PLATE CUP / LID  
Ø 12,5 cm Ø 4 in<sup>15/16</sup>



**230971**  
**COCOTTE BISEAUTÉE**  
SLANDED PLATE/CUP  
30 cl 10 oz<sup>1/8</sup>  
Ø 12 cm Ø 4 in<sup>3/4</sup>



**230970**  
**MINI COCOTTE BISEAUTÉE**  
SLANDED PLATE/CUP  
7 cl 2 oz<sup>3/8</sup>  
Ø 7,3 cm Ø 2 in<sup>7/8</sup>



**242053**  
**PLANCHE RONDE**  
ROUND BOARD  
Ø 29 cm Ø 11 in<sup>7/16</sup>



**242052**  
**PLANCHE**  
BOARD  
L 35 cm L 13 in<sup>3/4</sup>  
L 21 cm W 8 in<sup>1/4</sup>



**234950**  
**PLANCHE**  
BOARD  
L 25 cm L 9 in<sup>13/16</sup>  
L 13,5 cm W 5 in<sup>5/16</sup>



**PLATS À FOUR**  
BAKING DISHES

**237594**  
L 22,8 cm L 9 in  
H 5,4 cm H 2 in<sup>1/8</sup>  
L 16,2 cm W 6 in<sup>3/8</sup>

**237593**  
L 15,5 cm L 6 in<sup>1/8</sup>  
H 4,4 cm H 1 in<sup>3/4</sup>  
L 10,7 cm W 4 in<sup>3/16</sup>



SUITE DE LA COLLECTION SUR LA PAGE SUIVANTE  
THE COLLECTION CONTINUES ON THE NEXT PAGE

# BAHIA & COCOTTES

MADE IN EUROPE

**ARGILE VERTE - GREEN CLAY**  
GRÈS - STONEWARE



**230952**  
**ASSIETTE DE PRÉSENTATION**  
PRESENTATION PLATE  
Ø 29 cm    Ø 11 in<sup>7/16</sup>  
Ø INT : 25,5 cm 10 in<sup>1/16</sup>



**230951**  
**ASSIETTE PLATE**  
DINNER PLATE  
Ø 26 cm    Ø 10 in<sup>1/4</sup>  
Ø INT : 22 cm    8 in<sup>11/16</sup>



**230950**  
**ASSIETTE À DESSERT**  
DESSERT PLATE  
Ø 23 cm    Ø 9 in<sup>1/16</sup>  
Ø INT : 19,5 cm 7 in<sup>11/16</sup>



**230955**  
**ASSIETTE GOURMET**  
**GRAND BASSIN**  
GOURMET PLATE LARGE WELL  
Ø 26 cm    Ø 10 in<sup>1/4</sup>  
Ø INT : 14 cm    5 in<sup>1/2</sup>



**230953**  
**ASSIETTE CREUSE**  
SOUP PLATE  
Ø 20 cm    Ø 7 in<sup>7/8</sup>  
Ø INT : 16,5 cm 6 in<sup>1/2</sup>



**230958**  
**COCOTTE**  
DEEP PLATE / CUP  
50 cl    16 oz<sup>15/16</sup>  
Ø 14 cm    Ø 5 in<sup>1/2</sup>



**244138**  
**ASSIETTE COUVERCLE BI**  
**FINITION**  
PLATE CUP / LID  
Ø 12,5 cm    Ø 4 in<sup>15/16</sup>

**230959**  
**ASSIETTE COUVERCLE**  
PLATE CUP / LID  
Ø 12,5 cm    Ø 4 in<sup>15/16</sup>



**230957**  
**COCOTTE BISEAUTÉE**  
SLANDED PLATE / CUP  
30 cl    10 oz<sup>1/8</sup>  
Ø 12 cm    Ø 4 in<sup>3/4</sup>



**230956**  
**MINI COCOTTE BISEAUTÉE**  
SLANDED PLATE / CUP  
7 cl    2 oz<sup>3/8</sup>  
Ø 7,3 cm    Ø 2 in<sup>7/8</sup>



**234949**  
**PLANCHE**  
BOARD  
L 25 cm    L 9 in<sup>13/16</sup>  
l 13,5 cm    W 5 in<sup>5/16</sup>



# COCOTTES



## BLEU GOURMET - GOURMET BLUE



**234338**  
**COCOTTE**  
 DEEP PLATE / CUP  
**140 cl**    47 oz<sup>5/16</sup>  
**H 6,8 cm**    H 2 in<sup>11/16</sup>  
**Ø 17,5 cm**    Ø 6 in<sup>7/8</sup>



**230821**  
**COCOTTE**  
 DEEP PLATE / CUP  
**50 cl**    16 oz<sup>15/16</sup>  
**Ø 14 cm**    Ø 5 in<sup>1/2</sup>



**234339**  
**ASSIETTE COCOTTE**  
 SHALLOW PLATE / CUP  
**100 cl**    33 oz<sup>13/16</sup>  
**H 4 cm**    H 1 in<sup>9/16</sup>  
**Ø 22 cm**    Ø 8 in<sup>11/16</sup>



**235063**  
**ASSIETTE COCOTTE**  
 SHALLOW PLATE / CUP  
**70 cl**    23 oz<sup>11/16</sup>  
**H 3,5 cm**    H 1 in<sup>3/8</sup>  
**Ø 18 cm**    Ø 7 in<sup>1/16</sup>

**230820**  
**ASSIETTE COUVERCLE**  
 PLATE CUP / LID  
**Ø 12,5 cm**    Ø 4 in<sup>15/16</sup>



**234337**  
**COCOTTE BISEAUTÉE**  
 SLANDED PLATE/CUP  
**100 cl**    33 oz<sup>13/16</sup>  
**Ø 16 cm**    Ø 6 in<sup>5/16</sup>



**230822**  
**COCOTTE BISEAUTÉE**  
 SLANDED PLATE/CUP  
**30 cl**    10 oz<sup>1/8</sup>  
**Ø 12 cm**    Ø 4 in<sup>3/4</sup>



**230823**  
**MINI COCOTTE BISEAUTÉE**  
 SLANDED PLATE/CUP  
**7 cl**    2 oz<sup>3/8</sup>  
**Ø 7,3 cm**    Ø 2 in<sup>7/8</sup>

## ROSE NUDE - PINK NUDE



**243777**  
**COCOTTE**  
 DEEP PLATE / CUP  
**50 cl**    16 oz<sup>15/16</sup>  
**Ø 14 cm**    Ø 5 in<sup>1/2</sup>

**243780**  
**ASSIETTE COUVERCLE**  
 PLATE CUP / LID  
**Ø 12,5 cm**    Ø 4 in<sup>15/16</sup>



**243786**  
**COCOTTE BISEAUTÉE**  
 SLANDED PLATE/CUP  
**30 cl**    10 oz<sup>1/8</sup>  
**Ø 12 cm**    Ø 4 in<sup>3/4</sup>



**243783**  
**MINI COCOTTE BISEAUTÉE**  
 SLANDED PLATE/CUP  
**7 cl**    2 oz<sup>3/8</sup>  
**Ø 7,5 cm**    Ø 2 in<sup>15/16</sup>







# BLUE SHADES

MADE IN EUROPE 

## HALO



240242  
ASSIETTE DE PRÉSENTATION  
PRESENTATION PLATE  
Ø 29 cm    Ø 11 in<sup>7/16</sup>



240243  
ASSIETTE PLATE  
DINNER PLATE  
Ø 26 cm    Ø 10 in<sup>1/4</sup>



240244  
ASSIETTE À DESSERT  
DESSERT PLATE  
Ø 23 cm    Ø 9 in<sup>1/16</sup>

CODE EXPORT : 239655

CODE EXPORT : 239656



239658  
COCOTTE  
DEEP PLATE / CUP  
50 cl    16 oz<sup>15/16</sup>  
Ø 14 cm    Ø 5 in<sup>1/2</sup>



240245  
ASSIETTE COUVERCLE  
PLATE CUP / LID  
Ø 12,5 cm    Ø 4 in<sup>15/16</sup>  
CODE EXPORT : 239767



239659  
COCOTTE  
DEEP PLATE / CUP  
140 cl    47 oz<sup>5/16</sup>  
Ø 17,5 cm    Ø 6 in<sup>7/8</sup>



239660  
MINI COCOTTE BISEAUTÉE  
SLANDED PLATE / CUP  
Ø 7,5 cm    Ø 2 in<sup>15/16</sup>



239657  
BOL  
BOWL  
55 cl    18 oz<sup>5/8</sup>  
Ø 14 cm    Ø 5 in<sup>1/2</sup>





# BORÉAL

MADE IN EUROPE



**186770**  
**ASSIETTE DE PRÉSENTATION**  
 PRESENTATION PLATE  
 Ø 32,5 cm Ø 12 in<sup>13/16</sup>  
 Ø INT : 20 cm 7 in<sup>7/8</sup>



**186765**  
**ASSIETTE PLATE**  
 DINNER PLATE  
 Ø 28,5 cm Ø 11 in<sup>1/4</sup>  
 Ø INT : 17 cm 6 in<sup>11/16</sup>



**186767**  
**ASSIETTE À DESSERT**  
 DESSERT PLATE  
 Ø 22,5 cm Ø 8 in<sup>7/8</sup>  
 Ø INT : 15 cm 5 in<sup>7/8</sup>



**187263**  
**ASSIETTE À PAIN**  
 BREAD AND BUTTER PLATE  
 Ø 16 cm Ø 6 in<sup>5/16</sup>  
 Ø INT : 9,5 cm 3 in<sup>3/4</sup>



**204040**  
**ASSIETTE GOURMET OVALE**  
**GRAND BASSIN**  
 OVAL GOURMET PLATE LARGE  
 WELL  
 27 cl 9 oz<sup>1/8</sup>  
 L 32 cm L 12 in<sup>5/8</sup>  
 l 27 cm W 10 in<sup>5/8</sup>  
 Ø INT : 14,5 cm 5 in<sup>5/16</sup>



**207138**  
**ASSIETTE GOURMET OVALE**  
**PETIT BASSIN**  
 OVAL GOURMET PLATE SMALL  
 WELL  
 17 cl 5 oz<sup>3/4</sup>  
 L 30 cm L 11 in<sup>13/16</sup>  
 l 26 cm W 10 in<sup>1/4</sup>  
 Ø INT : 13,5 cm 5 in<sup>5/16</sup>



**207140**  
**ASSIETTE À PÂTES**  
 PASTA PLATE  
 Ø 29,5 cm Ø 11 in<sup>5/8</sup>  
 Ø INT : 17 cm 6 in<sup>11/16</sup>



**246215**  
**ASSIETTE CREUSE**  
 SOUP PLATE  
 Ø 20 cm Ø 7 in<sup>7/8</sup>



**207136**  
**ASSIETTE CREUSE OVALE**  
 OVAL SOUP PLATE  
 L 23,5 cm L 9 in<sup>1/4</sup>  
 l 20 cm W 7 in<sup>7/8</sup>



**186791**  
**TASSE À ESPRESSO**  
 ESPRESSO CUP  
 9 cl 3 oz<sup>1/16</sup>  
 H 6,6 cm H 2 in<sup>5/8</sup>  
 Ø 6,7 cm Ø 2 in<sup>5/8</sup>



**186793**  
**TASSE À THÉ / LUNGO**  
 TEA / LUNGO CUP  
 15 cl 5 oz<sup>1/16</sup>  
 H 6,8 cm H 2 in<sup>11/16</sup>  
 Ø 8,1 cm Ø 3 in<sup>3/16</sup>



**186795**  
**TASSE À DÉJEUNER**  
 BREAKFAST CUP  
 40 cl 13 oz<sup>1/2</sup>  
 H 7,5 cm H 2 in<sup>15/16</sup>  
 Ø 10,6 cm Ø 4 in<sup>3/16</sup>

**186792**  
**SOUCOUPE À ESPRESSO**  
**OVALE**  
 OVAL ESPRESSO SAUCER  
 L 14 cm L 5 in<sup>1/2</sup>  
 l 12 cm W 4 in<sup>3/4</sup>

**186794**  
**SOUCOUPE À THÉ / LUNGO**  
**OVALE**  
 OVAL TEA / LUNGO SAUCER  
 L 16,5 cm L 6 in<sup>1/2</sup>  
 l 14 cm W 5 in<sup>1/2</sup>

**186796**  
**SOUCOUPE À DÉJEUNER**  
**OVALE**  
 OVAL BREAKFAST SAUCER  
 L 20 cm L 7 in<sup>7/8</sup>  
 l 17 cm W 6 in<sup>11/16</sup>





# BORÉAL ONDE

MADE IN EUROPE 



**246871**  
**ASSIETTE DE PRÉSENTATION**  
PRESENTATION PLATE  
Ø 32,5 cm    Ø 12 in<sup>13/16</sup>  
Ø INT : 20 cm    7 in<sup>7/8</sup>



**246874**  
**ASSIETTE PLATE**  
DINNER PLATE  
Ø 28,5 cm    Ø 11 in<sup>1/4</sup>  
Ø INT : 17 cm    6 in<sup>11/16</sup>



**246877**  
**ASSIETTE À DESSERT**  
DESSERT PLATE  
Ø 22,5 cm    Ø 8 in<sup>7/8</sup>  
Ø INT : 15 cm    5 in<sup>7/8</sup>



**182614**  
**CLOCHE COUVRE ASSIETTE**  
PLATE COVER  
H 12,7 cm    H 5 in  
Ø 24 cm    Ø 9 in<sup>7/16</sup>



**182301**  
**CLOCHE COUVRE ASSIETTE**  
PLATE COVER  
H 8,6 cm    H 3 in<sup>3/8</sup>  
Ø 15 cm    Ø 5 in<sup>7/8</sup>



**206504**  
**BOUCHON CLOCHE COUVRE**  
ASSIETTE  
PLATE COVER LID  
Ø 5,2 cm    Ø 2 in<sup>1/16</sup>

**204043**  
**CLOCHE COUVRE ASSIETTE**  
PLATE COVER  
Ø 16,5 cm    Ø 6 in<sup>1/2</sup>





# BORÉAL SATIN



## BLANC - WHITE



**193319**  
ASSIETTE DE PRÉSENTATION  
PRESENTATION PLATE  
Ø 32,5 cm    Ø 12 in<sup>13/16</sup>  
Ø INT : 20 cm    7 in<sup>7/8</sup>



**193318**  
ASSIETTE PLATE  
DINNER PLATE  
Ø 28,5 cm    Ø 11 in<sup>1/4</sup>  
Ø INT : 17 cm    6 in<sup>11/16</sup>



**193320**  
ASSIETTE À DESSERT  
DESSERT PLATE  
Ø 22,5 cm    Ø 8 in<sup>7/8</sup>  
Ø INT : 15 cm    5 in<sup>7/8</sup>



**202470**  
ASSIETTE À PAIN  
BREAD AND BUTTER PLATE  
Ø 15 cm    Ø 5 in<sup>7/8</sup>  
Ø INT : 9,5 cm    3 in<sup>3/4</sup>



**207769**  
ASSIETTE GOURMET OVALE  
GRAND BASSIN  
OVAL GOURMET PLATE LARGE  
WELL  
27 cl    9 oz<sup>1/8</sup>  
L 32 cm    L 12 in<sup>5/8</sup>  
l 27 cm    W 10 in<sup>5/8</sup>  
Ø INT : 14,5 cm    5 in<sup>5/16</sup>



**193324**  
ASSIETTE GOURMET OVALE  
PETIT BASSIN  
OVAL GOURMET PLATE SMALL  
WELL  
17 cl    5 oz<sup>3/4</sup>  
L 30 cm    L 11 in<sup>13/16</sup>  
l 26 cm    W 10 in<sup>1/4</sup>  
Ø INT : 13,5 cm    5 in<sup>5/16</sup>



**223954**  
ASSIETTE À PÂTES  
PASTA PLATE  
Ø 29 cm    Ø 11 in<sup>7/16</sup>  
Ø INT : 17 cm    6 in<sup>11/16</sup>



**186791**  
TASSE À ESPRESSO  
ESPRESSO CUP  
9 cl    3 oz<sup>1/16</sup>  
H 6,6 cm    H 2 in<sup>5/8</sup>  
Ø 6,7 cm    Ø 2 in<sup>5/8</sup>



**186793**  
TASSE À THÉ / LUNGO  
TEA / LUNGO CUP  
15 cl    5 oz<sup>1/16</sup>  
H 6,8 cm    H 2 in<sup>11/16</sup>  
Ø 8,1 cm    Ø 3 in<sup>3/16</sup>



**186795**  
TASSE À DÉJEUNER  
BREAKFAST CUP  
40 cl    13 oz<sup>1/2</sup>  
H 7,5 cm    H 2 in<sup>15/16</sup>  
Ø 10,6 cm    Ø 4 in<sup>3/16</sup>

**193321**  
SOUCOUCPE À ESPRESSO  
OVALE  
OVAL ESPRESSO SAUCER  
L 14 cm    L 5 in<sup>1/2</sup>  
l 12 cm    W 4 in<sup>3/4</sup>

**193322**  
SOUCOUCPE À THÉ / LUNGO  
OVALE  
OVAL TEA / LUNGO SAUCER  
L 16,5 cm    L 6 in<sup>1/2</sup>  
l 14 cm    W 5 in<sup>1/2</sup>

**193323**  
SOUCOUCPE À DÉJEUNER  
OVALE  
OVAL BREAKFAST SAUCER  
L 20 cm    L 7 in<sup>7/8</sup>  
l 17 cm    W 6 in<sup>11/16</sup>

## DORÉ - GOLD



**225193**  
ASSIETTE DE PRÉSENTATION  
PRESENTATION PLATE  
Ø 32,5 cm    Ø 12 in<sup>13/16</sup>  
Ø INT : 20 cm    7 in<sup>7/8</sup>



**225194**  
ASSIETTE PLATE  
DINNER PLATE  
Ø 28,5 cm    Ø 11 in<sup>1/4</sup>  
Ø INT : 17 cm    6 in<sup>11/16</sup>



**225195**  
ASSIETTE À DESSERT  
DESSERT PLATE  
Ø 22,5 cm    Ø 8 in<sup>7/8</sup>  
Ø INT : 15 cm    5 in<sup>7/8</sup>



**225196**  
ASSIETTE À PAIN  
BREAD AND BUTTER PLATE  
Ø 15 cm    Ø 5 in<sup>7/8</sup>  
Ø INT : 9,5 cm    3 in<sup>3/4</sup>



**225197**  
ASSIETTE GOURMET OVALE  
PETIT BASSIN  
OVAL GOURMET PLATE SMALL  
WELL  
17 cl    5 oz<sup>3/4</sup>  
L 30 cm    L 11 in<sup>13/16</sup>  
l 26 cm    W 10 in<sup>1/4</sup>  
Ø INT : 13,5 cm    5 in<sup>5/16</sup>







# BRUME

MADE IN EUROPE 

**LAIT**  
WHITE MILK



**244749**  
ASSIETTE PLATE  
DINNER PLATE  
Ø 26 cm    Ø 10 in<sup>1/4</sup>

**ROSÉE**  
PINK



**241267**  
ASSIETTE PLATE  
DINNER PLATE  
Ø 26 cm    Ø 10 in<sup>1/4</sup>

**SABLE**  
SAND



**244751**  
ASSIETTE À DESSERT  
DESSERT PLATE  
Ø 20 cm    Ø 7 in<sup>7/8</sup>



**241268**  
ASSIETTE À DESSERT  
DESSERT PLATE  
Ø 20 cm    Ø 7 in<sup>7/8</sup>



**241276**  
ASSIETTE À DESSERT  
DESSERT PLATE  
Ø 20 cm    Ø 7 in<sup>7/8</sup>



**244753**  
BOL  
BOWL  
88 cl    29 oz<sup>3/4</sup>  
Ø 20 cm    Ø 7 in<sup>7/8</sup>



**241269**  
BOL  
BOWL  
88 cl    29 oz<sup>3/4</sup>  
Ø 20 cm    Ø 7 in<sup>7/8</sup>



**241277**  
BOL  
BOWL  
88 cl    29 oz<sup>3/4</sup>  
Ø 20 cm    Ø 7 in<sup>7/8</sup>



**244755**  
COUPELLE  
SMALL BOWL  
23 cl    7 oz<sup>3/4</sup>  
Ø 12,5 cm    Ø 4 in<sup>15/16</sup>



**241270**  
COUPELLE  
SMALL BOWL  
23 cl    7 oz<sup>3/4</sup>  
Ø 12,5 cm    Ø 4 in<sup>15/16</sup>



**241278**  
COUPELLE  
SMALL BOWL  
23 cl    7 oz<sup>3/4</sup>  
Ø 12,5 cm    Ø 4 in<sup>15/16</sup>





# COURONNE DORÉE

MADE IN EUROPE 



**246704**  
ASSIETTE DE PRÉSENTATION  
PRESENTATION PLATE  
Ø 32 cm    Ø 12 in<sup>5/8</sup>



**246707**  
ASSIETTE PLATE  
DINNER PLATE  
Ø 29 cm    Ø 11 in<sup>7/16</sup>



**246710**  
ASSIETTE PLATE  
DINNER PLATE  
Ø 26 cm    Ø 10 in<sup>1/4</sup>



**246713**  
ASSIETTE À DESSERT  
DESSERT PLATE  
Ø 20 cm    Ø 7 in<sup>7/8</sup>



**246716**  
ASSIETTE À PAIN  
BREAD AND BUTTER PLATE  
Ø 15 cm    Ø 5 in<sup>7/8</sup>



**246719**  
ASSIETTE CREUSE  
SOUP PLATE  
80 cl    27 oz<sup>1/16</sup>  
H 4,4 cm    H 1 in<sup>3/4</sup>  
Ø 24 cm    Ø 9 in<sup>7/16</sup>



**247348**  
COCOTTE  
DEEP PLATE / CUP  
50 cl    16 oz<sup>15/16</sup>  
Ø 14 cm    Ø 5 in<sup>1/2</sup>



**246721**  
PLAT OVALE  
OVAL DISH  
Ø 38 cm    Ø 14 in<sup>15/16</sup>



**207756**  
TASSE À ESPRESSO  
ESPRESSO CUP  
10 cl    3 oz<sup>2/8</sup>  
H 5,9 cm    H 2 in<sup>5/16</sup>  
Ø 5,8 cm    Ø 2 in<sup>5/16</sup>



**207757**  
TASSE À THÉ / LUNGO  
TEA / LUNGO CUP  
20 cl    6 oz<sup>3/4</sup>  
H 5,8 cm    H 2 in<sup>5/16</sup>  
Ø 8,4 cm    Ø 3 in<sup>5/16</sup>



**207758**  
TASSE À DÉJEUNER  
BREAKFAST CUP  
40 cl    13 oz<sup>1/2</sup>  
H 7,4 cm    H 2 in<sup>15/16</sup>  
Ø 10,3 cm    Ø 4 in<sup>1/16</sup>

**247345**  
SOUCOUBE À ESPRESSO  
ESPRESSO SAUCER  
Ø 12,6 cm    Ø 4 in<sup>15/16</sup>

**247346**  
SOUCOUBE À THÉ / LUNGO  
TEA / LUNGO SAUCER  
Ø 15,8 cm    Ø 6 in<sup>1/4</sup>

**247347**  
SOUCOUBE À DÉJEUNER  
BREAKFAST SAUCER  
Ø 18 cm    Ø 7 in<sup>1/16</sup>





# COURONNE ARGENTÉE

MADE IN EUROPE 

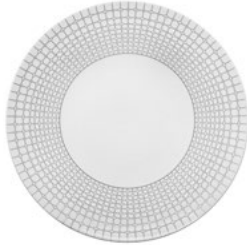

**247230**  
**ASSIETTE DE PRÉSENTATION**  
PRESENTATION PLATE  
Ø 32 cm    Ø 12 in<sup>5/8</sup>

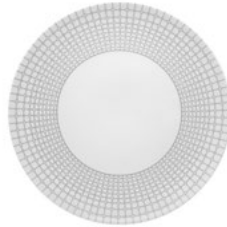

**247229**  
**ASSIETTE PLATE**  
DINNER PLATE  
Ø 29 cm    Ø 11 in<sup>7/16</sup>

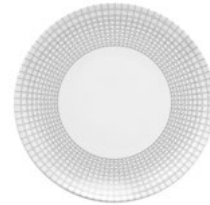

**247228**  
**ASSIETTE PLATE**  
DINNER PLATE  
Ø 26 cm    Ø 10 in<sup>1/4</sup>

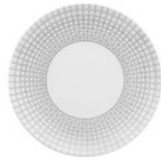

**247231**  
**ASSIETTE À DESSERT**  
DESSERT PLATE  
Ø 20 cm    Ø 7 in<sup>7/8</sup>

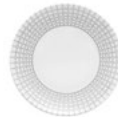

**247232**  
**ASSIETTE À PAIN**  
BREAD AND BUTTER PLATE  
Ø 15 cm    Ø 5 in<sup>7/8</sup>



**247233**  
**ASSIETTE CREUSE**  
SOUP PLATE  
80 cl    27 oz<sup>1/16</sup>  
H 4,4 cm    H 1 in<sup>3/4</sup>  
Ø 24 cm    Ø 9 in<sup>7/16</sup>



**247344**  
**COCOTTE**  
DEEP PLATE / CUP  
50 cl    16 oz<sup>15/16</sup>  
Ø 14 cm    Ø 5 in<sup>1/2</sup>



**247234**  
**PLAT OVALE**  
OVAL DISH  
Ø 38 cm    Ø 14 in<sup>15/16</sup>



**207756**  
**TASSE À ESPRESSO**  
ESPRESSO CUP  
10 cl    3 oz<sup>3/8</sup>  
H 5,9 cm    H 2 in<sup>5/16</sup>  
Ø 5,8 cm    Ø 2 in<sup>5/16</sup>



**207757**  
**TASSE À THÉ / LUNGO**  
TEA / LUNGO CUP  
20 cl    6 oz<sup>3/4</sup>  
H 5,8 cm    H 2 in<sup>5/16</sup>  
Ø 8,4 cm    Ø 3 in<sup>5/16</sup>



**207758**  
**TASSE À DÉJEUNER**  
BREAKFAST CUP  
40 cl    13 oz<sup>1/2</sup>  
H 7,4 cm    H 2 in<sup>15/16</sup>  
Ø 10,3 cm    Ø 4 in<sup>1/16</sup>

**247341**  
**SOUCOUPE À ESPRESSO**  
ESPRESSO SAUCER  
Ø 12,6 cm    Ø 4 in<sup>15/16</sup>

**247342**  
**SOUCOUPE À THÉ / LUNGO**  
TEA / LUNGO SAUCER  
Ø 15,8 cm    Ø 6 in<sup>1/4</sup>

**247343**  
**SOUCOUPE À DÉJEUNER**  
BREAKFAST SAUCER  
Ø 18 cm    Ø 7 in<sup>1/16</sup>







**247371**  
ASSIETTE DE PRÉSENTATION  
PRESENTATION PLATE  
Ø 32 cm    Ø 12 in<sup>5/8</sup>



**247372**  
ASSIETTE PLATE  
DINNER PLATE  
Ø 29 cm    Ø 11 in<sup>7/16</sup>



**247373**  
ASSIETTE PLATE  
DINNER PLATE  
Ø 26 cm    Ø 10 in<sup>1/4</sup>



**247374**  
ASSIETTE À DESSERT  
DESSERT PLATE  
Ø 20 cm    Ø 7 in<sup>7/8</sup>



**247375**  
ASSIETTE À PAIN  
BREAD AND BUTTER PLATE  
Ø 15 cm    Ø 5 in<sup>7/8</sup>



**247376**  
ASSIETTE CREUSE  
SOUP PLATE  
80 cl    27 oz<sup>1/16</sup>  
H 4,4 cm    H 1 in<sup>3/4</sup>  
Ø 24 cm    Ø 9 in<sup>7/16</sup>



**247779**  
SOUCOUBE À ESPRESSO  
ESPRESSO SAUCER  
Ø 12,6 cm    Ø 4 in<sup>15/16</sup>



**247781**  
SOUCOUBE À THÉ / LUNGO  
TEA / LUNGO SAUCER  
Ø 15,8 cm    Ø 6 in<sup>1/4</sup>



**247783**  
SOUCOUBE À DÉJEUNER  
BREAKFAST SAUCER  
Ø 18 cm    Ø 7 in<sup>1/16</sup>





# GRAPHIQUE

MADE IN EUROPE 



**245447**  
ASSIETTE DE PRÉSENTATION  
PRESENTATION PLATE  
Ø 32,5 cm    Ø 12 in<sup>13/16</sup>  
Ø INT : 20 cm    7 in<sup>7/8</sup>



**245449**  
ASSIETTE PLATE  
DINNER PLATE  
Ø 28,5 cm    Ø 11 in<sup>1/4</sup>  
Ø INT : 17 cm    6 in<sup>11/16</sup>



**245451**  
ASSIETTE À DESSERT  
DESSERT PLATE  
Ø 22,5 cm    Ø 8 in<sup>7/8</sup>  
Ø INT : 15 cm    5 in<sup>7/8</sup>



**245453**  
ASSIETTE À PAIN  
BREAD AND BUTTER PLATE  
Ø 15 cm    Ø 5 in<sup>7/8</sup>  
Ø INT : 9,5 cm    3 in<sup>3/4</sup>



**245457**  
ASSIETTE GOURMET OVALE  
GRAND BASSIN  
OVAL GOURMET PLATE LARGE  
WELL  
27 cl    9 oz<sup>1/8</sup>  
L 32 cm    L 12 in<sup>5/8</sup>  
l 27 cm    W 10 in<sup>5/8</sup>  
Ø INT : 14,5 cm    5 in<sup>5/16</sup>



**245455**  
ASSIETTE GOURMET OVALE  
PETIT BASSIN  
OVAL GOURMET PLATE SMALL  
WELL  
17 cl    5 oz<sup>3/4</sup>  
L 30 cm    L 11 in<sup>13/16</sup>  
l 26 cm    W 10 in<sup>1/4</sup>  
Ø INT : 13,5 cm    5 in<sup>5/16</sup>



**245741**  
ASSIETTE À PÂTES  
PASTA PLATE  
Ø 29,5 cm    Ø 11 in<sup>5/8</sup>  
Ø INT : 17 cm    6 in<sup>11/16</sup>



**207756**  
TASSE À ESPRESSO  
ESPRESSO CUP  
10 cl    3 oz<sup>3/8</sup>  
H 5,9 cm    H 2 in<sup>5/16</sup>  
Ø 5,8 cm    Ø 2 in<sup>5/16</sup>



**207757**  
TASSE À THÉ / LUNGO  
TEA / LUNGO CUP  
20 cl    6 oz<sup>3/4</sup>  
H 5,8 cm    H 2 in<sup>5/16</sup>  
Ø 8,4 cm    Ø 3 in<sup>5/16</sup>



**207758**  
TASSE À DÉJEUNER  
BREAKFAST CUP  
40 cl    13 oz<sup>1/2</sup>  
H 7,4 cm    H 2 in<sup>15/16</sup>  
Ø 10,3 cm    Ø 4 in<sup>11/16</sup>

**246162**  
SOUCOUBE À ESPRESSO  
ESPRESSO SAUCER  
Ø 12,6 cm    Ø 4 in<sup>15/16</sup>

**246163**  
SOUCOUBE À THÉ / LUNGO  
TEA / LUNGO SAUCER  
Ø 15 cm    Ø 5 in<sup>7/8</sup>

**246268**  
SOUCOUBE À DÉJEUNER  
BREAKFAST SAUCER  
Ø 18 cm    Ø 7 in<sup>11/16</sup>





# GRAPHIQUE DORÉ

MADE IN EUROPE 



**246109**  
ASSIETTE DE PRÉSENTATION  
PRESENTATION PLATE  
Ø 32,5 cm    Ø 12 in<sup>13/16</sup>  
Ø INT : 20 cm    7 in<sup>7/8</sup>



**246110**  
ASSIETTE PLATE  
DINNER PLATE  
Ø 28,5 cm    Ø 11 in<sup>1/4</sup>  
Ø INT : 17 cm    6 in<sup>11/16</sup>



**246111**  
ASSIETTE À DESSERT  
DESSERT PLATE  
Ø 22,5 cm    Ø 8 in<sup>7/8</sup>  
Ø INT : 15 cm    5 in<sup>7/8</sup>



**246112**  
ASSIETTE À PAIN  
BREAD AND BUTTER PLATE  
Ø 15 cm    Ø 5 in<sup>7/8</sup>  
Ø INT : 9,5 cm    3 in<sup>3/4</sup>



**246114**  
ASSIETTE GOURMET OVALE  
GRAND BASSIN  
OVAL GOURMET PLATE LARGE  
WELL  
27 cl    9 oz<sup>1/8</sup>  
L 32 cm    L 12 in<sup>5/8</sup>  
l 27 cm    W 10 in<sup>5/8</sup>  
Ø INT : 14,5 cm    5 in<sup>5/16</sup>



**246113**  
ASSIETTE GOURMET OVALE  
PETIT BASSIN  
OVAL GOURMET PLATE SMALL  
WELL  
17 cl    5 oz<sup>3/4</sup>  
L 30 cm    L 11 in<sup>13/16</sup>  
l 26 cm    W 10 in<sup>1/4</sup>  
Ø INT : 13,5 cm    5 in<sup>5/16</sup>



**246115**  
ASSIETTE À PÂTES  
PASTA PLATE  
Ø 29,5 cm    Ø 11 in<sup>5/8</sup>  
Ø INT : 17 cm    6 in<sup>11/16</sup>



**246164**  
SOUCOUBE À ESPRESSO  
ESPRESSO SAUCER  
Ø 12,6 cm    Ø 4 in<sup>15/16</sup>



**246165**  
SOUCOUBE À THÉ / LUNGO  
TEA / LUNGO SAUCER  
Ø 15 cm    Ø 5 in<sup>7/8</sup>



**246269**  
SOUCOUBE À DÉJEUNER  
BREAKFAST SAUCER  
Ø 18 cm    Ø 7 in<sup>1/16</sup>

**207756**  
TASSE À ESPRESSO  
ESPRESSO CUP  
10 cl    3 oz<sup>3/8</sup>  
H 5,9 cm    H 2 in<sup>5/16</sup>  
Ø 5,8 cm    Ø 2 in<sup>5/16</sup>

**207757**  
TASSE À THÉ / LUNGO  
TEA / LUNGO CUP  
20 cl    6 oz<sup>3/4</sup>  
H 5,8 cm    H 2 in<sup>5/16</sup>  
Ø 8,4 cm    Ø 3 in<sup>5/16</sup>

**207758**  
TASSE À DÉJEUNER  
BREAKFAST CUP  
40 cl    13 oz<sup>1/2</sup>  
H 7,4 cm    H 2 in<sup>15/16</sup>  
Ø 10,3 cm    Ø 4 in<sup>1/16</sup>





# LA VAISSELLE DE L'ÉCONOME

MADE IN EUROPE 



**237318**  
ASSIETTE PLATE  
DINNER PLATE  
Ø 26 cm    Ø 10 in<sup>1/4</sup>



**237317**  
ASSIETTE PLATE  
DINNER PLATE  
Ø 24 cm    Ø 9 in<sup>7/16</sup>



**237316**  
ASSIETTE À DESSERT  
DESSERT PLATE  
Ø 18 cm    Ø 7 in<sup>1/16</sup>



**237315**  
ASSIETTE À PAIN  
BREAD AND BUTTER PLATE  
Ø 14 cm    Ø 5 in<sup>1/2</sup>



**237324**  
ASSIETTE CREUSE  
SOUP PLATE  
1,3 L    43 oz<sup>15/16</sup>  
Ø 24 cm    Ø 9 in<sup>7/16</sup>



**237323**  
BOL  
BOWL  
90 cl    30 oz<sup>7/16</sup>  
Ø 18 cm    Ø 7 in<sup>1/16</sup>



**237322**  
BOL  
BOWL  
47 cl    15 oz<sup>7/8</sup>  
Ø 14 cm    Ø 5 in<sup>1/2</sup>



**237320**  
BOL DROIT  
STRAIGHT BOWL  
1,3 L    43 oz<sup>15/16</sup>  
Ø 18 cm    Ø 7 in<sup>1/16</sup>



**237319**  
BOL DROIT  
STRAIGHT BOWL  
50 cl    16 oz<sup>15/16</sup>  
Ø 14 cm    Ø 5 in<sup>1/2</sup>





# MODULO



## ROUND - ROND



**207120**  
ASSIETTE DE PRÉSENTATION  
PRESENTATION PLATE  
Ø 32 cm    Ø 12 in<sup>5/8</sup>



**207112**  
ASSIETTE PLATE  
DINNER PLATE  
Ø 29 cm    Ø 11 in<sup>7/16</sup>



**207113**  
ASSIETTE PLATE  
DINNER PLATE  
Ø 26 cm    Ø 10 in<sup>1/4</sup>



**207111**  
ASSIETTE À DESSERT  
DESSERT PLATE  
Ø 20 cm    Ø 7 in<sup>7/8</sup>



**207119**  
ASSIETTE À PAIN  
BREAD AND BUTTER PLATE  
Ø 15 cm    Ø 5 in<sup>7/8</sup>



**246108**  
ASSIETTE CREUSE  
SOUP PLATE  
80 cl    27 oz<sup>1/16</sup>  
H 4,4 cm    H 1 in<sup>3/4</sup>  
Ø 24 cm    Ø 9 in<sup>7/16</sup>



**207114**  
ASSIETTE CREUSE  
SOUP PLATE  
45 cl    15 oz<sup>3/16</sup>  
H 3,7 cm    H 1 in<sup>7/16</sup>  
Ø 20 cm    Ø 7 in<sup>7/8</sup>



**136535**  
COUPE À PIED  
FOOTED BOWL  
70cl    23 oz<sup>11/16</sup>  
H 6,2cm    H 2 in<sup>7/16</sup>  
Ø 24 cm    Ø 9 in<sup>7/16</sup>



**136530**  
COUPELLE  
SMALL BOWL  
4,5 cl    1 oz<sup>1/2</sup>  
Ø 8 cm    Ø 3 in<sup>1/8</sup>



**142722**  
SALADIER  
SERVING BOWL  
250 cl    84 oz<sup>9/16</sup>  
H 12,4 cm    H 4 in<sup>7/8</sup>  
Ø 28 cm    Ø 11 in



**136529**  
BOL  
BOWL  
200 cl    67 oz<sup>5/8</sup>  
H 11 cm    H 4 in<sup>5/16</sup>  
Ø 24 cm    Ø 9 in<sup>7/16</sup>



**136511**  
BOL  
BOWL  
130 cl    43 oz<sup>15/16</sup>  
H 9,5 cm    H 3 in<sup>3/4</sup>  
Ø 20 cm    Ø 7 in<sup>7/8</sup>



**136528**  
BOL  
BOWL  
67 cl    22 oz<sup>5/8</sup>  
H 7,5 cm    H 2 in<sup>15/16</sup>  
Ø 16 cm    Ø 6 in<sup>5/16</sup>



**154245**  
BOL  
BOWL  
55 cl    18 oz<sup>5/8</sup>  
H 8 cm    H 3 in<sup>1/8</sup>  
Ø 14 cm    Ø 5 in<sup>1/2</sup>



**136510**  
BOL  
BOWL  
27 cl    9 oz<sup>1/8</sup>  
H 5,5 cm    H 2 in<sup>3/4</sup>  
Ø 12 cm    Ø 4 in<sup>3/4</sup>



**234855**  
MUG  
30 cl    10 oz<sup>1/8</sup>  
H 8,8 cm    H 3 in<sup>7/16</sup>



**247894** NEW  
PLAT OVALE  
OVAL DISH  
L 38 cm    L 14 in<sup>15/16</sup>  
l 23,5 cm    W 9 in<sup>1/4</sup>



**136524**  
PLAT À TARTE  
PIE DISH  
Ø 32 cm    Ø 12 in<sup>5/8</sup>



**209382**  
PRÉSENTOIR À GÂTEAUX  
CAKE STAND  
Ø 32 cm    Ø 12 in<sup>5/8</sup>



**247583**  
CLOCHE EN VERRE  
GLASS DOME COVER  
H 20,5 cm    H 8 in<sup>1/16</sup>  
Ø 28 cm    Ø 11 in



SUITE DE LA COLLECTION SUR LA PAGE SUIVANTE  
THE COLLECTION CONTINUES ON THE NEXT PAGE





# MODULO

MADE IN EUROPE

## CARRÉ - SQUARE



**207118**  
ASSIETTE PLATE CARRÉE  
SQUARED DINNER PLATE  
L 28 cm L 11 in  
l 28 cm W 11 in



**207115**  
ASSIETTE PLATE CARRÉE  
SQUARED DINNER PLATE  
L 24 cm L 9 in<sup>7/16</sup>  
l 24 cm W 9 in<sup>7/16</sup>



**207117**  
ASSIETTE PLATE CARRÉE  
SQUARED DINNER PLATE  
L 20 cm L 7 in<sup>7/8</sup>  
l 20 cm W 7 in<sup>7/8</sup>



**207123**  
ASSIETTE PLATE CARRÉE  
SQUARED DINNER PLATE  
L 14 cm L 5 in<sup>1/2</sup>  
l 14 cm W 5 in<sup>1/2</sup>



**136502**  
COUPELLE CARRÉE  
SQUARE DISH  
12,5 cl 4 oz<sup>1/4</sup>  
L 12 cm L 4 in<sup>3/4</sup>  
H 3,5 cm H 1 in<sup>3/8</sup>  
l 12 cm W 4 in<sup>3/4</sup>



**136503**  
COUPELLE CARRÉE  
SQUARE DISH  
6 cl 2 oz  
L 8 cm L 3 in<sup>1/8</sup>  
H 2,5 cm H 1 in  
l 8 cm W 3 in<sup>1/8</sup>

## RECTANGULAIRE - RECTANGULAR



**181485**  
ASSIETTE PLATE  
RECTANGULAIRE  
RECTANGULAR DINNER PLATE  
L 34 cm L 13 in<sup>3/8</sup>  
l 26 cm W 10 in<sup>1/4</sup>



**207122**  
ASSIETTE PLATE  
RECTANGULAIRE  
RECTANGULAR DINNER PLATE  
L 30 cm L 11 in<sup>13/16</sup>  
l 22 cm W 8 in<sup>11/16</sup>



**207110**  
ASSIETTE PLATE  
RECTANGULAIRE  
RECTANGULAR DINNER PLATE  
L 26 cm L 10 in<sup>1/4</sup>  
l 18 cm W 7 in<sup>1/16</sup>



**207753**  
PLAT À CAKE  
CAKE DISH  
L 20 cm L 7 in<sup>7/8</sup>  
l 12 cm W 4 in<sup>3/4</sup>

**207754**  
PLAT À CAKE  
CAKE DISH  
L 40 cm L 15 in<sup>3/4</sup>  
l 16 cm W 6 in<sup>5/16</sup>



**161036**  
PETIT PLATEAU  
SMALL TRAY  
L 30,5 cm L 12 in  
l 10 cm W 3 in<sup>15/16</sup>

## ACCESSOIRES ET NEWCOOK MODULO - ACCESSORIES AND NEWCOOK MODULO



**162015**  
RAMEQUIN  
RAMEKIN  
Ø 9,5 cm Ø 3 in<sup>3/4</sup>



**162011**  
ASSIETTE À CRÈME BRULÉE  
CRÈME BRULÉE PLATE  
Ø 14 cm Ø 5 in<sup>1/2</sup>



**164138**  
PLAT À ESCARGOTS  
SNAIL DISH  
Ø 16,6 cm Ø 6 in<sup>9/16</sup>



**164402**  
BEURRIER AVEC COUVERCLE  
BUTTER DISH WITH LID  
L 18 cm L 7 in<sup>1/16</sup>  
H 6,8 cm H 2 in<sup>11/16</sup>  
l 12,5 cm W 4 in<sup>15/16</sup>



**182915**  
ENSEMBLE SALIÈRE /  
POIVRIÈRE  
SALT CELLAR / PEPPER CELLAR





# MODULO NATURE

## PIERRE DE LAVE - LAVA STONE



**194455**  
ASSIETTE DE PRÉSENTATION  
PRESENTATION PLATE  
Ø 31,5 cm    Ø 12 in<sup>3/8</sup>



**194454**  
ASSIETTE PLATE  
DINNER PLATE  
Ø 27,9 cm    Ø 11 in



**246750**  
ASSIETTE PLATE  
DINNER PLATE  
Ø 26 cm    Ø 10 in<sup>1/4</sup>

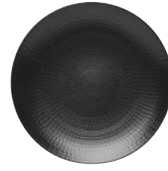

**194453**  
ASSIETTE À DESSERT  
DESSERT PLATE  
Ø 21 cm    Ø 8 in<sup>1/4</sup>



**230092**  
ASSIETTE À PAIN  
BREAD AND BUTTER PLATE  
Ø 16 cm    Ø 6 in<sup>5/16</sup>



**234455**  
ASSIETTE CREUSE  
SOUP PLATE  
50 cl    16 oz<sup>15/16</sup>  
Ø 25 cm    Ø 9 in<sup>13/16</sup>



**246755**  
ASSIETTE CREUSE  
SOUP PLATE  
H 4,5 cm    H 1 in<sup>3/4</sup>  
Ø 22 cm    Ø 8 in<sup>11/16</sup>



**194452**  
ASSIETTE CREUSE  
SOUP PLATE  
Ø 21 cm    Ø 8 in<sup>1/4</sup>



**194462**  
BOL  
BOWL  
150 cl    50 oz<sup>3/4</sup>  
H 8 cm    H 3 in<sup>1/8</sup>  
Ø 24 cm    Ø 9 in<sup>7/16</sup>



**194457**  
BOL  
BOWL  
50 cl    16 oz<sup>15/16</sup>  
H 5,5 cm    H 2 in<sup>3/16</sup>  
Ø 17,7 cm    Ø 6 in<sup>15/16</sup>



**246759**  
BOL  
BOWL  
53 cl    17 oz<sup>15/16</sup>  
H 6 cm    H 2 in<sup>3/8</sup>  
Ø 14,5 cm    Ø 5 in<sup>11/16</sup>



**194456**  
BOL  
BOWL  
58 cl    19 oz<sup>5/8</sup>  
H 7,5 cm    H 2 in<sup>15/16</sup>  
Ø 14 cm    Ø 5 in<sup>1/2</sup>



**194458**  
COUPELLE  
SMALL BOWL  
22 cl    7 oz<sup>7/16</sup>  
H 6 cm    H 2 in<sup>3/8</sup>  
Ø 10 cm    Ø 3 in<sup>15/16</sup>



**194461**  
MUG  
33 cl    11 oz<sup>3/16</sup>  
H 10 cm    H 3 in<sup>15/16</sup>



**230093**  
TASSE À THÉ / LUNGO  
TEA / LUNGO CUP  
25 cl    8 oz<sup>7/16</sup>  
H 7,5 cm    H 2 in<sup>15/16</sup>  
Ø 8,8 cm    Ø 3 in<sup>7/16</sup>



**194459**  
TASSE À ESPRESSO  
ESPRESSO CUP  
11,5 cl    3 oz<sup>7/8</sup>  
H 6 cm    H 2 in<sup>3/8</sup>  
Ø 6,8 cm    Ø 2 in<sup>11/16</sup>

**230094**  
SOUCOUBE À THÉ / LUNGO  
TEA / LUNGO SAUCER  
Ø 15,9 cm    Ø 6 in<sup>1/4</sup>

**194460**  
SOUCOUBE À ESPRESSO  
ESPRESSO SAUCER  
Ø 12,5 cm    Ø 4 in<sup>15/16</sup>



SUITE DE LA COLLECTION SUR LA PAGE SUIVANTE  
THE COLLECTION CONTINUES ON THE NEXT PAGE

# MODULO NATURE

## KAOLIN - KAOLIN



**184088**  
ASSIETTE DE PRÉSENTATION  
PRESENTATION PLATE  
Ø 31,5 cm    Ø 12 in<sup>3/8</sup>



**184077**  
ASSIETTE PLATE  
DINNER PLATE  
Ø 27,9 cm    Ø 11 in



**246751**  
ASSIETTE PLATE  
DINNER PLATE  
Ø 26 cm    Ø 10 in<sup>1/4</sup>



**184078**  
ASSIETTE À DESSERT  
DESSERT PLATE  
Ø 21 cm    Ø 8 in<sup>1/4</sup>



**209092**  
ASSIETTE À PAIN  
BREAD AND BUTTER PLATE  
Ø 16 cm    Ø 6 in<sup>5/16</sup>



**234449**  
ASSIETTE CREUSE  
SOUP PLATE  
50 cl    16 oz<sup>15/16</sup>  
Ø 25 cm    Ø 9 in<sup>13/16</sup>



**246756**  
ASSIETTE CREUSE  
SOUP PLATE  
H 4,5 cm    H 1 in<sup>3/4</sup>  
Ø 22 cm    Ø 8 in<sup>11/16</sup>



**184079**  
ASSIETTE CREUSE  
SOUP PLATE  
Ø 21 cm    Ø 8 in<sup>1/4</sup>



**184087**  
BOL  
BOWL  
150 cl    50 oz<sup>3/4</sup>  
H 8 cm    H 3 in<sup>1/8</sup>  
Ø 24 cm    Ø 9 in<sup>7/16</sup>



**184086**  
BOL  
BOWL  
50 cl    16 oz<sup>15/16</sup>  
H 5,5 cm    H 2 in<sup>3/16</sup>  
Ø 17,7 cm    Ø 6 in<sup>15/16</sup>



**246760**  
BOL  
BOWL  
53 cl    17 oz<sup>15/16</sup>  
H 6 cm    H 2 in<sup>3/8</sup>  
Ø 14,5 cm    Ø 5 in<sup>11/16</sup>



**184084**  
BOL  
BOWL  
58 cl    19 oz<sup>5/8</sup>  
H 7,5 cm    H 2 in<sup>15/16</sup>  
Ø 14 cm    Ø 5 in<sup>1/2</sup>



**184085**  
COUPELLE  
SMALL BOWL  
22 cl    7 oz<sup>7/16</sup>  
H 6 cm    H 2 in<sup>3/8</sup>  
Ø 10 cm    Ø 3 in<sup>15/16</sup>



**184083**  
MUG  
33 cl    11 oz<sup>3/16</sup>  
H 10 cm    H 3 in<sup>15/16</sup>



**230163**  
TASSE À THÉ / LUNGO  
TEA / LUNGO CUP  
25 cl    8 oz<sup>7/16</sup>  
H 7,5 cm    H 2 in<sup>15/16</sup>  
Ø 8,8 cm    Ø 3 in<sup>7/16</sup>



**184081**  
TASSE À ESPRESSO  
ESPRESSO CUP  
11,5 cl    3 oz<sup>7/8</sup>  
H 6 cm    H 2 in<sup>3/8</sup>  
Ø 6,8 cm    Ø 2 in<sup>11/16</sup>

**230164**  
SOUCOUCPE À THÉ / LUNGO  
TEA / LUNGO SAUCER  
Ø 15,9 cm    Ø 6 in<sup>1/4</sup>

**184082**  
SOUCOUCPE À ESPRESSO  
ESPRESSO SAUCER  
Ø 12,5 cm    Ø 4 in<sup>15/16</sup>



# MODULO NATURE

## TERRE D'OMBRE - TAUPE



**184101**  
**ASSIETTE DE PRÉSENTATION**  
PRESENTATION PLATE  
Ø 31,5 cm    Ø 12 in<sup>3/8</sup>



**184090**  
**ASSIETTE PLATE**  
DINNER PLATE  
Ø 27,9 cm    Ø 11 in



**246752**  
**ASSIETTE PLATE**  
DINNER PLATE  
Ø 26 cm    Ø 10 in<sup>1/4</sup>



**184091**  
**ASSIETTE À DESSERT**  
DESSERT PLATE  
Ø 21 cm    Ø 8 in<sup>1/4</sup>



**209093**  
**ASSIETTE À PAIN**  
BREAD AND BUTTER PLATE  
Ø 16 cm    Ø 6 in<sup>5/16</sup>



**234451**  
**ASSIETTE CREUSE**  
SOUP PLATE  
50 cl    16 oz<sup>15/16</sup>  
Ø 25 cm    Ø 9 in<sup>13/16</sup>



**246757**  
**ASSIETTE CREUSE**  
SOUP PLATE  
H 4,5 cm    H 1 in<sup>3/4</sup>  
Ø 22 cm    Ø 8 in<sup>11/16</sup>



**184092**  
**ASSIETTE CREUSE**  
SOUP PLATE  
Ø 21 cm    Ø 8 in<sup>1/4</sup>



**184100**  
**BOL**  
BOWL  
150 cl    50 oz<sup>3/4</sup>  
H 8 cm    H 3 in<sup>1/8</sup>  
Ø 24 cm    Ø 9 in<sup>7/16</sup>



**184099**  
**BOL**  
BOWL  
50 cl    16 oz<sup>15/16</sup>  
H 5,5 cm    H 2 in<sup>3/16</sup>  
Ø 17,7 cm    Ø 6 in<sup>15/16</sup>



**246761**  
**BOL**  
BOWL  
53 cl    17 oz<sup>15/16</sup>  
H 6 cm    H 2 in<sup>3/8</sup>  
Ø 14,5 cm    Ø 5 in<sup>11/16</sup>



**184097**  
**BOL**  
BOWL  
58 cl    19 oz<sup>5/8</sup>  
H 7,5 cm    H 2 in<sup>15/16</sup>  
Ø 14 cm    Ø 5 in<sup>1/2</sup>



**184098**  
**COUPELLE**  
SMALL BOWL  
22 cl    7 oz<sup>7/16</sup>  
H 6 cm    H 2 in<sup>3/8</sup>  
Ø 10 cm    Ø 3 in<sup>15/16</sup>



**184096**  
**MUG**  
33 cl    11 oz<sup>3/16</sup>  
H 10 cm    H 3 in<sup>15/16</sup>



**230165**  
**TASSE À THÉ / LUNGO**  
TEA / LUNGO CUP  
25 cl    8 oz<sup>7/16</sup>  
H 7,5 cm    H 2 in<sup>15/16</sup>  
Ø 8,8 cm    Ø 3 in<sup>7/16</sup>



**184094**  
**TASSE À ESPRESSO**  
ESPRESSO CUP  
11,5 cl    3 oz<sup>7/8</sup>  
H 6 cm    H 2 in<sup>3/8</sup>  
Ø 6,8 cm    Ø 2 in<sup>11/16</sup>

**230166**  
**SOUCOUPE À THÉ / LUNGO**  
TEA / LUNGO SAUCER  
Ø 15,9 cm    Ø 6 in<sup>1/4</sup>

**184095**  
**SOUCOUPE À ESPRESSO**  
ESPRESSO SAUCER  
Ø 12,5 cm    Ø 4 in<sup>15/16</sup>



SUITE DE LA COLLECTION SUR LA PAGE SUIVANTE  
THE COLLECTION CONTINUES ON THE NEXT PAGE

# MODULO NATURE

## BLEU GALET - BLUE



**225342**  
ASSIETTE DE PRÉSENTATION  
PRESENTATION PLATE  
Ø 31,5 cm    Ø 12 in<sup>3/8</sup>



**225343**  
ASSIETTE PLATE  
DINNER PLATE  
Ø 27,9 cm    Ø 11 in



**246747**  
ASSIETTE PLATE  
DINNER PLATE  
Ø 26 cm    Ø 10 in<sup>1/4</sup>



**225344**  
ASSIETTE À DESSERT  
DESSERT PLATE  
Ø 21 cm    Ø 8 in<sup>1/4</sup>



**225353**  
ASSIETTE À PAIN  
BREAD AND BUTTER PLATE  
Ø 16 cm    Ø 6 in<sup>5/16</sup>



**234457**  
ASSIETTE CREUSE  
SOUP PLATE  
50 cl    16 oz<sup>15/16</sup>  
Ø 25 cm    Ø 9 in<sup>13/16</sup>



**246748**  
ASSIETTE CREUSE  
SOUP PLATE  
H 4,5 cm    H 1 in<sup>3/4</sup>  
Ø 22 cm    Ø 8 in<sup>11/16</sup>



**225345**  
ASSIETTE CREUSE  
SOUP PLATE  
Ø 21 cm    Ø 8 in<sup>1/4</sup>



**225349**  
BOL  
BOWL  
150 cl    50 oz<sup>3/4</sup>  
H 8 cm    H 3 in<sup>1/8</sup>  
Ø 24 cm    Ø 9 in<sup>7/16</sup>



**225347**  
BOL  
BOWL  
50 cl    16 oz<sup>15/16</sup>  
H 5,5 cm    H 2 in<sup>3/16</sup>  
Ø 17,7 cm    Ø 6 in<sup>15/16</sup>



**246749**  
BOL  
BOWL  
53 cl    17 oz<sup>15/16</sup>  
H 6 cm    H 2 in<sup>3/8</sup>  
Ø 14,5 cm    Ø 5 in<sup>11/16</sup>



**246777**  
BOL  
BOWL  
58 cl    19 oz<sup>5/8</sup>  
H 7,5 cm    H 2 in<sup>15/16</sup>  
Ø 14 cm    Ø 5 in<sup>1/2</sup>



**225346**  
COUPELLE  
SMALL BOWL  
22 cl    7 oz<sup>7/16</sup>  
H 6 cm    H 2 in<sup>3/8</sup>  
Ø 10 cm    Ø 3 in<sup>15/16</sup>



**246746**  
MUG  
33 cl    11 oz<sup>3/16</sup>  
H 10 cm    H 3 in<sup>15/16</sup>



**230167**  
TASSE À THÉ / LUNGO  
TEA / LUNGO CUP  
25 cl    8 oz<sup>7/16</sup>  
H 7,5 cm    H 2 in<sup>15/16</sup>  
Ø 8,8 cm    Ø 3 in<sup>7/16</sup>



**225351**  
TASSE À ESPRESSO  
ESPRESSO CUP  
11,5 cl    3 oz<sup>7/8</sup>  
H 6 cm    H 2 in<sup>3/8</sup>  
Ø 6,8 cm    Ø 2 in<sup>11/16</sup>

**230168**  
SOUCOUBE À THÉ / LUNGO  
TEA / LUNGO SAUCER  
Ø 15,9 cm    Ø 6 in<sup>1/4</sup>

**225352**  
SOUCOUBE À ESPRESSO  
ESPRESSO SAUCER  
Ø 12,5 cm    Ø 4 in<sup>15/16</sup>



# MODULO NATURE

## JADE - JADE GREEN



**235681**  
**ASSIETTE DE PRÉSENTATION**  
PRESENTATION PLATE  
Ø 31,5 cm    Ø 12 in<sup>3/8</sup>



**235682**  
**ASSIETTE PLATE**  
DINNER PLATE  
Ø 27,9 cm    Ø 11 in



**246753**  
**ASSIETTE PLATE**  
DINNER PLATE  
Ø 26 cm    Ø 10 in<sup>1/4</sup>



**235683**  
**ASSIETTE À DESSERT**  
DESSERT PLATE  
Ø 21 cm    Ø 8 in<sup>1/4</sup>



**235685**  
**ASSIETTE À PAIN**  
BREAD AND BUTTER PLATE  
Ø 16 cm    Ø 6 in<sup>5/16</sup>



**235688**  
**ASSIETTE CREUSE**  
SOUP PLATE  
50 cl    16 oz<sup>15/16</sup>  
Ø 25 cm    Ø 9 in<sup>13/16</sup>



**246758**  
**ASSIETTE CREUSE**  
SOUP PLATE  
H 4,5 cm    H 1 in<sup>3/4</sup>  
Ø 22 cm    Ø 8 in<sup>11/16</sup>



**235684**  
**ASSIETTE CREUSE**  
SOUP PLATE  
Ø 21 cm    Ø 8 in<sup>1/4</sup>



**235689**  
**BOL**  
BOWL  
150 cl    50 oz<sup>3/4</sup>  
H 8 cm    H 3 in<sup>1/8</sup>  
Ø 24 cm    Ø 9 in<sup>7/16</sup>



**235687**  
**BOL**  
BOWL  
50 cl    16 oz<sup>15/16</sup>  
H 5,5 cm    H 2 in<sup>3/16</sup>  
Ø 17,7 cm    Ø 6 in<sup>15/16</sup>



**246762**  
**BOL**  
BOWL  
53 cl    17 oz<sup>15/16</sup>  
H 6 cm    H 2 in<sup>3/8</sup>  
Ø 14,5 cm    Ø 5 in<sup>11/16</sup>



**246064**  
**BOL**  
BOWL  
58 cl    19 oz<sup>5/8</sup>  
H 7,5 cm    H 2 in<sup>15/16</sup>  
Ø 14 cm    Ø 5 in<sup>1/2</sup>



**235686**  
**COUPELLE**  
SMALL BOWL  
22 cl    7 oz<sup>7/16</sup>  
H 6 cm    H 2 in<sup>3/8</sup>  
Ø 10 cm    Ø 3 in<sup>15/16</sup>



**246420**  
**MUG**  
33 cl    11 oz<sup>3/16</sup>  
H 10 cm    H 3 in<sup>15/16</sup>



**235692**  
**TASSE À THÉ / LUNGO**  
TEA / LUNGO CUP  
25 cl    8 oz<sup>7/16</sup>  
H 7,5 cm    H 2 in<sup>15/16</sup>  
Ø 8,8 cm    Ø 3 in<sup>7/16</sup>



**235690**  
**TASSE À ESPRESSO**  
ESPRESSO CUP  
11,5 cl    3 oz<sup>7/8</sup>  
H 6 cm    H 2 in<sup>3/8</sup>  
Ø 6,8 cm    Ø 2 in<sup>11/16</sup>

**235693**  
**SOUCOUPE À THÉ / LUNGO**  
TEA / LUNGO SAUCER  
Ø 15,9 cm    Ø 6 in<sup>1/4</sup>

**235691**  
**SOUCOUPE À ESPRESSO**  
ESPRESSO SAUCER  
Ø 12,5 cm    Ø 4 in<sup>15/16</sup>









**243263**  
**ASSIETTE DE PRÉSENTATION**  
PRESENTATION PLATE  
Ø 32 cm    Ø 12 in<sup>5/8</sup>



**243265**  
**ASSIETTE PLATE**  
DINNER PLATE  
Ø 27,9 cm    Ø 11 in



**243267**  
**ASSIETTE À DESSERT**  
DESSERT PLATE  
Ø 24 cm    Ø 9 in<sup>7/16</sup>



**243269**  
**ASSIETTE À PAIN**  
BREAD AND BUTTER PLATE  
Ø 15 cm    Ø 5 in<sup>7/8</sup>



**243271**  
**ASSIETTE CREUSE**  
SOUP PLATE  
Ø 24 cm    Ø 9 in<sup>7/16</sup>



**243273**  
**BOL**  
BOWL  
Ø 18 cm    Ø 7 in<sup>1/16</sup>



**243275**  
**COUPELLE**  
SMALL BOWL  
50 cl    16 oz<sup>15/16</sup>  
H 8 cm    H 3 in<sup>1/8</sup>  
Ø 13 cm    Ø 5 in<sup>1/8</sup>



## LE THÉ ET LE CAFÉ

Chez Guy Degrenne, le plaisir des sens se prolonge dans l'esthétique. Nos collections dédiées au thé et au café transforment chaque dégustation en un moment unique. Redécouvrez notre théière Salam, une icône intemporelle depuis 1953, qui allie nos savoir-faire dans le travail de la porcelaine et de l'inox. Explorez aussi nos tasses et accessoires conçus pour maîtriser l'art du thé et du café avec élégance et précision.

## TEA & COFFEE

*At Guy Degrenne, sensory pleasure extends into aesthetics. Our collections dedicated to tea and coffee turn every tasting into a unique moment. Rediscover our Salam teapot, an iconic piece since 1953, combining our expertise in porcelain and stainless steel. Explore our cups and accessories designed to master the art of tea and coffee with elegance and precision.*





LE THÉ ET LE CAFÉ  
TEA & COFFEE

SALAM . . .	189, 191, 193, 195 et 197
SALAM ACCESSOIRES . . . . .	199
EMPILEO . . . . .	201
SALAM THÉ . . . . .	203
MODULO . . . . .	203
COLLECTION L . . . . .	205
COLLECTION L COUTURE . . . . .	205
COLLECTION L FRAGMENT . . . . .	205
COLLECTION L PERLES DE ROSÉE . . . . .	205
COLLECTION L RAYON . . . . .	205
SD ONE . . . . .	205
GALON OR . . . . .	207
GALON PLATINE . . . . .	207
BORÉAL . . . . .	209
BORÉAL SATIN . . . . .	209
COURONNE DORÉE . . . . .	211
COURONNE ARGENTÉE . . . . .	211
GRAPHIQUE . . . . .	213
GRAPHIQUE DORÉ . . . . .	213
NEWPORT . . . . .	215
MODULO NATURE . . . . .	217



# SALAM

MADE IN FRANCE

BLANC - WHITE



**211990**  
**THÉIÈRE AVEC CLOCHE MIROIR**  
TEA POT WITH MIRROR CLOCHE  
130 cl 43 oz<sup>15/16</sup>  
H 15,2 cm H 6 in  
8 tasses



**211989**  
**THÉIÈRE AVEC CLOCHE MIROIR**  
TEA POT WITH MIRROR CLOCHE  
100 cl 33 oz<sup>13/16</sup>  
H 13,1 cm H 5 in<sup>3/16</sup>  
6 tasses



**211988**  
**THÉIÈRE AVEC CLOCHE MIROIR**  
TEA POT WITH MIRROR CLOCHE  
70 cl 23 oz<sup>11/16</sup>  
H 11,1 cm H 4 in<sup>3/8</sup>  
4 tasses



**211987**  
**THÉIÈRE AVEC CLOCHE MIROIR**  
TEA POT WITH MIRROR CLOCHE  
35 cl 11 oz<sup>13/16</sup>  
H 8,2 cm H 3 in<sup>1/4</sup>  
2 tasses

NOIR - BLACK



**211994**  
**THÉIÈRE AVEC CLOCHE INOX BROSSÉE**  
TEA POT WITH BRUSHED STAINLESS STEEL CLOCHE  
130 cl 43 oz<sup>15/16</sup>  
H 15,2 cm H 6 in  
8 tasses



**211993**  
**THÉIÈRE AVEC CLOCHE INOX BROSSÉE**  
TEA POT WITH BRUSHED STAINLESS STEEL CLOCHE  
100 cl 33 oz<sup>13/16</sup>  
H 13,1 cm H 5 in<sup>3/16</sup>  
6 tasses



**211992**  
**THÉIÈRE AVEC CLOCHE INOX BROSSÉE**  
TEA POT WITH BRUSHED STAINLESS STEEL CLOCHE  
70 cl 23 oz<sup>11/16</sup>  
H 11,1 cm H 4 in<sup>3/8</sup>  
4 tasses



**211991**  
**THÉIÈRE AVEC CLOCHE INOX BROSSÉE**  
TEA POT WITH BRUSHED STAINLESS STEEL CLOCHE  
35 cl 11 oz<sup>13/16</sup>  
H 8,2 cm H 3 in<sup>1/4</sup>  
2 tasses

NOIR - BLACK



**216414**  
**THÉIÈRE AVEC CLOCHE NOIRE**  
TEA POT WITH BACK CLOCHE  
100 cl 33 oz<sup>13/16</sup>  
H 13,1 cm H 5 in<sup>3/16</sup>  
6 tasses



**216410**  
**THÉIÈRE AVEC CLOCHE NOIRE**  
TEA POT WITH BACK CLOCHE  
70 cl 23 oz<sup>11/16</sup>  
H 11,1 cm H 4 in<sup>3/8</sup>  
4 tasses



**243214**  
**THÉIÈRE AVEC CLOCHE NOIRE**  
TEA POT WITH BACK CLOCHE  
45 cl 15 oz<sup>3/16</sup>  
6 tasses





# SALAM

MADE IN EUROPE 

BLANC - WHITE

NOIR - BLACK



**189949**  
**CORPS THÉIÈRE**  
TEA POT BODY  
**130 cl** 43 oz<sup>15/16</sup>  
**H 15,2 cm** H 6 in  
**8 tasses**

**150447**  
**CORPS THÉIÈRE**  
TEA POT BODY  
**130 cl** 43 oz<sup>15/16</sup>  
**H 15,2 cm** H 6 in  
**8 tasses**



**189948**  
**CORPS THÉIÈRE**  
TEA POT BODY  
**100 cl** 33 oz<sup>13/16</sup>  
**H 13,1 cm** H 5 in<sup>3/16</sup>  
**6 tasses**

**150456**  
**CORPS THÉIÈRE**  
TEA POT BODY  
**100 cl** 33 oz<sup>13/16</sup>  
**H 13,1 cm** H 5 in<sup>3/16</sup>  
**6 tasses**



**189947**  
**CORPS THÉIÈRE**  
TEA POT BODY  
**70 cl** 23 oz<sup>11/16</sup>  
**H 11,1 cm** H 4 in<sup>3/8</sup>  
**4 tasses**

**150455**  
**CORPS THÉIÈRE**  
TEA POT BODY  
**70 cl** 23 oz<sup>11/16</sup>  
**H 11,1 cm** H 4 in<sup>3/8</sup>  
**4 tasses**



**189946**  
**CORPS THÉIÈRE**  
TEA POT BODY  
**35 cl** 11 oz<sup>13/16</sup>  
**H 8,2 cm** H 3 in<sup>1/4</sup>  
**2 tasses**

**150450**  
**CORPS THÉIÈRE**  
TEA POT BODY  
**35 cl** 11 oz<sup>13/16</sup>  
**H 8,2 cm** H 3 in<sup>1/4</sup>  
**2 tasses**



# SALAM

MADE IN FRANCE

**ZINC**  
BLANC - WHITE



216416  
THÉIÈRE AVEC CLOCHE ZINC  
TEA POT WITH ZINC CLOCHE  
100 cl 33 oz<sup>13/16</sup>  
H 13,1 cm H 5 in<sup>3/16</sup>  
6 tasses

**BRONZE**  
BLANC - WHITE



216415  
THÉIÈRE AVEC CLOCHE BRONZE  
TEA POT WITH BRONZE CLOCHE  
100 cl 33 oz<sup>13/16</sup>  
H 13,1 cm H 5 in<sup>3/16</sup>  
6 tasses

**BLEU - BLUE**  
BLANC - WHITE



225359  
THÉIÈRE AVEC CLOCHE BLEUE  
TEA POT WITH BLUE CLOCHE  
100 cl 33 oz<sup>13/16</sup>  
H 13,1 cm H 5 in<sup>3/16</sup>  
6 tasses



216412  
THÉIÈRE AVEC CLOCHE ZINC  
TEA POT WITH ZINC CLOCHE  
70 cl 23 oz<sup>11/16</sup>  
H 11,1 cm H 4 in<sup>3/8</sup>  
4 tasses



216411  
THÉIÈRE AVEC CLOCHE BRONZE  
TEA POT WITH BRONZE CLOCHE  
70 cl 23 oz<sup>11/16</sup>  
H 11,1 cm H 4 in<sup>3/8</sup>  
4 tasses



225358  
THÉIÈRE AVEC CLOCHE BLEUE  
TEA POT WITH BLUE CLOCHE  
70 cl 23 oz<sup>11/16</sup>  
H 11,1 cm H 4 in<sup>3/8</sup>  
4 tasses

**ÉMERAUDE - EMERALD**  
NOIR - BLACK



240138  
THÉIÈRE AVEC CLOCHE  
ÉMERAUDE  
TEA POT WITH EMERALD  
CLOCHE  
100 cl 33 oz<sup>13/16</sup>  
H 13,1 cm H 5 in<sup>3/16</sup>  
6 tasses

**BRONZE**  
NOIR - BLACK



237415  
THÉIÈRE AVEC CLOCHE BRONZE  
TEA POT WITH BRONZE CLOCHE  
100 cl 33 oz<sup>13/16</sup>  
H 13,1 cm H 5 in<sup>3/16</sup>  
6 tasses



240125  
THÉIÈRE AVEC CLOCHE  
ÉMERAUDE  
TEA POT WITH EMERALD CLOCHE  
70 cl 23 oz<sup>11/16</sup>  
H 11,1 cm H 4 in<sup>3/8</sup>  
4 tasses



237414  
THÉIÈRE AVEC CLOCHE BRONZE  
TEA POT WITH BRONZE CLOCHE  
70 cl 23 oz<sup>11/16</sup>  
H 11,1 cm H 4 in<sup>3/8</sup>  
4 tasses



# SALAM

MADE IN FRANCE

**BORDEAUX** - BURGUNDY  
BLANC - WHITE



248422 **NEW**  
THÉIÈRE AVEC CLOCHE  
BORDEAUX  
TEA POT WITH BURGUNDY CLOCHE  
100 cl 33 oz<sup>13/16</sup>  
H 13,1 cm H 5 in<sup>3/16</sup>  
6 tasses

**ROUGE** (pomme d'amour) - RED  
BLANC - WHITE



238934  
THÉIÈRE AVEC CLOCHE ROUGE  
MÉTALLIQUE  
TEA POT WITH RED METALIC  
CLOCHE  
100 cl 33 oz<sup>13/16</sup>  
H 13,1 cm H 5 in<sup>3/16</sup>  
6 tasses

**ROUGE** (pomme d'amour) - RED  
NOIR - BLACK



248421 **NEW**  
THÉIÈRE AVEC CLOCHE  
BORDEAUX  
TEA POT WITH BURGUNDY CLOCHE  
70 cl 23 oz<sup>11/16</sup>  
H 11,1 cm H 4 in<sup>3/8</sup>  
4 tasses



238935  
THÉIÈRE AVEC CLOCHE ROUGE  
MÉTALLIQUE  
TEA POT WITH RED METALIC  
CLOCHE  
100 cl 33 oz<sup>13/16</sup>  
H 13,1 cm H 5 in<sup>3/16</sup>  
6 tasses

**DORÉ** - GOLDEN  
BLANC - WHITE



234217  
THÉIÈRE AVEC CLOCHE DORÉE  
TEA POT WITH GOLD CLOCHE  
100 cl 33 oz<sup>13/16</sup>  
H 13,1 cm H 5 in<sup>3/16</sup>  
6 tasses

**OR** - GOLD  
BLANC - WHITE



234216  
THÉIÈRE AVEC CLOCHE DORÉE  
TEA POT WITH GOLD CLOCHE  
70 cl 23 oz<sup>11/16</sup>  
H 11,1 cm H 4 in<sup>3/8</sup>  
4 tasses



243794  
THÉIÈRE  
TEA POT  
70 cl 23 oz<sup>11/16</sup>  
H 11,1 cm H 4 in<sup>3/8</sup>  
4 tasses



# SALAM

MADE IN FRANCE

**BLANC**  
WHITE



**242321**  
**THÉIÈRE**  
TEA POT  
**70 cl**      23 oz<sup>11/16</sup>  
**H 11,1 cm**      H 4 in<sup>3/8</sup>  
**4 tasses**

**BLEU GOURMET**  
GOURMET BLUE



**242323**  
**THÉIÈRE**  
TEA POT  
**70 cl**      23 oz<sup>11/16</sup>  
**H 11,1 cm**      H 4 in<sup>3/8</sup>  
**4 tasses**



**242322**  
**THÉIÈRE**  
TEA POT  
**100 cl**      33 oz<sup>13/16</sup>  
**H 13,1 cm**      H 5 in<sup>3/16</sup>  
**6 tasses**



**242324**  
**THÉIÈRE**  
TEA POT  
**100 cl**      33 oz<sup>13/16</sup>  
**H 13,1 cm**      H 5 in<sup>3/16</sup>  
**6 tasses**

**ROSE NUDE**  
PINK NUDE



**242325**  
**THÉIÈRE**  
TEA POT  
**70 cl**      23 oz<sup>11/16</sup>  
**H 11,1 cm**      H 4 in<sup>3/8</sup>  
**4 tasses**

**VERT AMANDE**  
ALMOND GREEN



**242327**  
**THÉIÈRE**  
TEA POT  
**70 cl**      23 oz<sup>11/16</sup>  
**H 11,1 cm**      H 4 in<sup>3/8</sup>  
**4 tasses**



**242326**  
**THÉIÈRE**  
TEA POT  
**100 cl**      33 oz<sup>13/16</sup>  
**H 13,1 cm**      H 5 in<sup>3/16</sup>  
**6 tasses**



**242328**  
**THÉIÈRE**  
TEA POT  
**100 cl**      33 oz<sup>13/16</sup>  
**H 13,1 cm**      H 5 in<sup>3/16</sup>  
**6 tasses**





# SALAM ACCESSOIRES

MADE IN EUROPE 

BLANC - WHITE

NOIR - BLACK



205136  
COUVERCLE DE THÉIÈRE  
TEA POT LID  
6 / 8 tasses



210576  
COUVERCLE DE THÉIÈRE  
TEA POT LID  
6 / 8 tasses



248306  
INFUSEUR  
INFUSER  
6 / 8 tasses



205135  
COUVERCLE DE THÉIÈRE  
TEA POT LID  
2 / 4 tasses



210575  
COUVERCLE DE THÉIÈRE  
TEA POT LID  
2 / 4 tasses



248305  
INFUSEUR  
INFUSER  
2 / 4 tasses



187276  
SUCRIER  
SUGAR BOWL  
28 cl 9 oz<sup>7/16</sup>  
H 6,2 cm H 2 in<sup>7/16</sup>



150475  
SUCRIER  
SUGAR BOWL  
28 cl 9 oz<sup>7/16</sup>  
H 6,2 cm H 2 in<sup>7/16</sup>



217133  
FEUTRINE POUR THÉIÈRE  
FELT FOR TEA POT  
8 tasses



187283  
CORPS SUCRIER  
SUGAR BOWL WITHOUT THE LID  
28 cl 9 oz<sup>7/16</sup>



150469  
CORPS SUCRIER  
SUGAR BOWL WITHOUT THE LID  
28 cl 9 oz<sup>7/16</sup>

217132  
FEUTRINE POUR THÉIÈRE  
FELT FOR TEA POT  
6 tasses

217131  
FEUTRINE POUR THÉIÈRE  
FELT FOR TEA POT  
4 tasses

217130  
FEUTRINE POUR THÉIÈRE  
FELT FOR TEA POT  
2 tasses



187277  
CRÉMIER  
CREAM JUG  
15 cl 5 oz<sup>1/16</sup>



150485  
CRÉMIER  
CREAM JUG  
15 cl 5 oz<sup>1/16</sup>



# EMPILEO

MADE IN EUROPE

## BLANC WHITE



**242636**  
**TASSE À ESPRESSO**  
ESPRESSO CUP  
10 cl 3 oz<sup>2/8</sup>  
Ø 7,2 cm Ø 2 in<sup>13/16</sup>



**242628**  
**TASSE À THÉ / LUNGO**  
TEA / LUNGO CUP  
25 cl 8 oz<sup>7/16</sup>  
Ø 9,5 cm Ø 3 in<sup>3/4</sup>



**242620**  
**TASSE À DÉJEUNER**  
BREAKFAST CUP  
39 cl 13 oz<sup>3/16</sup>  
Ø 9,5 cm Ø 3 in<sup>3/4</sup>



**242644**  
**SOUCOUPE**  
SAUCER  
Ø 15 cm Ø 5 in<sup>7/8</sup>

## BLEU GOURMET GOURMET BLUE



**242640**  
**TASSE À ESPRESSO**  
ESPRESSO CUP  
10 cl 3 oz<sup>2/8</sup>  
Ø 7,2 cm Ø 2 in<sup>13/16</sup>



**242632**  
**TASSE À THÉ / LUNGO**  
TEA / LUNGO CUP  
25 cl 8 oz<sup>7/16</sup>  
Ø 9,5 cm Ø 3 in<sup>3/4</sup>



**242624**  
**TASSE À DÉJEUNER**  
BREAKFAST CUP  
39 cl 13 oz<sup>3/16</sup>  
Ø 9,5 cm Ø 3 in<sup>3/4</sup>



**242648**  
**SOUCOUPE**  
SAUCER  
Ø 15 cm Ø 5 in<sup>7/8</sup>

## ROSE NUDE PINK NUDE



**242642**  
**TASSE À ESPRESSO**  
ESPRESSO CUP  
10 cl 3 oz<sup>2/8</sup>  
Ø 7,2 cm Ø 2 in<sup>13/16</sup>



**242634**  
**TASSE À THÉ / LUNGO**  
TEA / LUNGO CUP  
25 cl 8 oz<sup>7/16</sup>  
Ø 9,5 cm Ø 3 in<sup>3/4</sup>



**242626**  
**TASSE À DÉJEUNER**  
BREAKFAST CUP  
39 cl 13 oz<sup>3/16</sup>  
Ø 9,5 cm Ø 3 in<sup>3/4</sup>



**242650**  
**SOUCOUPE**  
SAUCER  
Ø 15 cm Ø 5 in<sup>7/8</sup>

## VERT AMANDE ALMOND GREEN



**242638**  
**TASSE À ESPRESSO**  
ESPRESSO CUP  
10 cl 3 oz<sup>2/8</sup>  
Ø 7,2 cm Ø 2 in<sup>13/16</sup>



**242630**  
**TASSE À THÉ / LUNGO**  
TEA / LUNGO CUP  
25 cl 8 oz<sup>7/16</sup>  
Ø 9,5 cm Ø 3 in<sup>3/4</sup>



**242622**  
**TASSE À DÉJEUNER**  
BREAKFAST CUP  
39 cl 13 oz<sup>3/16</sup>  
Ø 9,5 cm Ø 3 in<sup>3/4</sup>



**242646**  
**SOUCOUPE**  
SAUCER  
Ø 15 cm Ø 5 in<sup>7/8</sup>



## INOX STAINLESS STEEL

**242652**  
**SOUCOUPE**  
SAUCER  
Ø 15 cm Ø 5 in<sup>7/8</sup>

MADE IN FRANCE





# SALAM THÉ

MADE IN EUROPE 



**210946**  
**TASSE À ESPRESSO**  
ESPRESSO CUP  
11 cl 3 oz<sup>3/4</sup>  
H 5,1 cm H 2 in  
Ø 7 cm Ø 2 in<sup>3/4</sup>



**210947**  
**TASSE À THÉ / LUNGO**  
TEA / LUNGO CUP  
25 cl 8 oz<sup>7/16</sup>  
H 5,6 cm H 2 in<sup>3/16</sup>  
Ø 9,8 cm Ø 3 in<sup>7/8</sup>



**210948**  
**TASSE À DÉJEUNER**  
BREAKFAST CUP  
42 cl 14 oz<sup>3/16</sup>  
H 8 cm H 3 in<sup>1/8</sup>  
Ø 10,4 cm Ø 4 in<sup>1/8</sup>



**210949**  
**MUG**  
38 cl 12 oz<sup>7/8</sup>  
H 9,6 cm H 3 in<sup>3/4</sup>  
Ø 9,1 cm Ø 3 in<sup>9/16</sup>



**210950**  
**SOUCOUPE**  
SAUCER  
Ø 16 cm Ø 6 in<sup>5/16</sup>



**210951**  
**SOUCOUPE**  
SAUCER  
Ø 18 cm Ø 7 in<sup>1/16</sup>

# MODULO

MADE IN EUROPE 



**234855**  
**MUG**  
30 cl 10 oz<sup>1/8</sup>  
H 8,8 cm H 3 in<sup>7/16</sup>





# COLLECTION L



## COLLECTION L



**227828**  
TASSE À ESPRESSO  
ESPRESSO CUP  
10 cl 3 oz<sup>3/8</sup>  
H 6 cm H 2 in<sup>3/8</sup>  
Ø 5,7 cm Ø 2 in<sup>1/4</sup>

**227831**  
SOUCOUCPE À ESPRESSO  
ESPRESSO SAUCER  
Ø 12,6 cm Ø 4 in<sup>15/16</sup>



**227829**  
TASSE À THÉ / LUNGO  
TEA / LUNGO CUP  
25 cl 8 oz<sup>7/16</sup>  
H 6 cm H 2 in<sup>3/8</sup>  
Ø 8,5 cm Ø 3 in<sup>3/8</sup>

**227832**  
SOUCOUCPE À THÉ / LUNGO  
TEA / LUNGO SAUCER  
Ø 15,8 cm Ø 6 in<sup>1/4</sup>



**227828**  
TASSE À ESPRESSO  
ESPRESSO CUP  
10 cl 3 oz<sup>3/8</sup>  
H 6 cm H 2 in<sup>3/8</sup>  
Ø 5,7 cm Ø 2 in<sup>1/4</sup>

**237404**  
SOUCOUCPE À ESPRESSO  
ESPRESSO SAUCER  
Ø 12,6 cm Ø 4 in<sup>15/16</sup>



**227829**  
TASSE À THÉ / LUNGO  
TEA / LUNGO CUP  
25 cl 8 oz<sup>7/16</sup>  
H 6 cm H 2 in<sup>3/8</sup>  
Ø 8,5 cm Ø 3 in<sup>3/8</sup>

**237405**  
SOUCOUCPE À THÉ / LUNGO  
TEA / LUNGO SAUCER  
Ø 15,8 cm Ø 6 in<sup>1/4</sup>

## COLLECTION L FRAGMENT



**227828**  
TASSE À ESPRESSO  
ESPRESSO CUP  
10 cl 3 oz<sup>3/8</sup>  
H 6 cm H 2 in<sup>3/8</sup>  
Ø 5,7 cm Ø 2 in<sup>1/4</sup>

**227849**  
SOUCOUCPE À ESPRESSO  
ESPRESSO SAUCER  
Ø 12,6 cm Ø 4 in<sup>15/16</sup>



**227829**  
TASSE À THÉ / LUNGO  
TEA / LUNGO CUP  
25 cl 8 oz<sup>7/16</sup>  
H 6 cm H 2 in<sup>3/8</sup>  
Ø 8,5 cm Ø 3 in<sup>3/8</sup>

**227850**  
SOUCOUCPE À THÉ / LUNGO  
TEA / LUNGO SAUCER  
Ø 15,8 cm Ø 6 in<sup>1/4</sup>



**227828**  
TASSE À ESPRESSO  
ESPRESSO CUP  
10 cl 3 oz<sup>3/8</sup>  
H 6 cm H 2 in<sup>3/8</sup>  
Ø 5,7 cm Ø 2 in<sup>1/4</sup>

**233928**  
SOUCOUCPE À ESPRESSO  
ESPRESSO SAUCER  
Ø 12,6 cm Ø 4 in<sup>15/16</sup>



**227829**  
TASSE À THÉ / LUNGO  
TEA / LUNGO CUP  
25 cl 8 oz<sup>7/16</sup>  
H 6 cm H 2 in<sup>3/8</sup>  
Ø 8,5 cm Ø 3 in<sup>3/8</sup>

**233929**  
SOUCOUCPE À THÉ / LUNGO  
TEA / LUNGO SAUCER  
Ø 15,8 cm Ø 6 in<sup>1/4</sup>

## COLLECTION L RAYON



**227828**  
TASSE À ESPRESSO  
ESPRESSO CUP  
10 cl 3 oz<sup>3/8</sup>  
H 6 cm H 2 in<sup>3/8</sup>  
Ø 5,7 cm Ø 2 in<sup>1/4</sup>

**247039**  
SOUCOUCPE À ESPRESSO  
ESPRESSO SAUCER  
Ø 12,6 cm Ø 4 in<sup>15/16</sup>



**227829**  
TASSE À THÉ / LUNGO  
TEA / LUNGO CUP  
25 cl 8 oz<sup>7/16</sup>  
H 6 cm H 2 in<sup>3/8</sup>  
Ø 8,5 cm Ø 3 in<sup>3/8</sup>

**247040**  
SOUCOUCPE À THÉ / LUNGO  
TEA / LUNGO SAUCER  
Ø 15,8 cm Ø 6 in<sup>1/4</sup>



**242910**  
TASSE À ESPRESSO  
ESPRESSO CUP  
7 cl 2 oz<sup>3/8</sup>  
H 6,3 cm H 2 in<sup>1/2</sup>  
Ø 6 cm Ø 2 in<sup>3/8</sup>

**242914**  
SOUCOUCPE  
SAUCER  
Ø 14 cm Ø 5 in<sup>1/2</sup>



**242912**  
TASSE À THÉ / LUNGO  
TEA / LUNGO CUP  
15 cl 5 oz<sup>1/16</sup>  
H 8 cm H 3 in<sup>1/8</sup>  
Ø 7,8 cm Ø 3 in<sup>1/16</sup>

**242914**  
SOUCOUCPE  
SAUCER  
Ø 14 cm Ø 5 in<sup>1/2</sup>

## SD ONE







# GALON



## OR - GOLD



**241093**  
**TASSE À ESPRESSO**  
 ESPRESSO CUP  
 10 cl 3 oz<sup>3/8</sup>  
 H 6 cm H 2 in<sup>3/8</sup>  
 Ø 5,5 cm Ø 2 in<sup>3/16</sup>



**247598**  
**TASSE À THÉ / LUNGO**  
 TEA / LUNGO CUP  
 25 cl 8 oz<sup>7/16</sup>  
 H 6 cm H 2 in<sup>3/8</sup>  
 Ø 8,5 cm Ø 3 in<sup>3/8</sup>



**241102**  
**TASSE À DÉJEUNER**  
 BREAKFAST CUP  
 34 cl 11 oz<sup>1/2</sup>  
 H 7 cm H 2 in<sup>3/4</sup>  
 Ø 9,8 cm Ø 3 in<sup>7/8</sup>

**241094**  
**SOUCOUPE À ESPRESSO**  
 ESPRESSO SAUCER  
 Ø 12,5 cm Ø 4 in<sup>15/16</sup>

**241105**  
**SOUCOUPE À THÉ / LUNGO**  
 TEA / LUNGO SAUCER  
 Ø 15 cm Ø 5 in<sup>7/8</sup>

**241103**  
**SOUCOUPE À DÉJEUNER**  
 BREAKFAST SAUCER  
 Ø 19 cm Ø 7 in<sup>1/2</sup>



**241100**  
**THÉIÈRE**  
 TEA POT  
 100 cl 33 oz<sup>13/16</sup>  
 H 15,7 cm H 6 in<sup>3/16</sup>  
 Ø 12,4 cm Ø 4 in<sup>7/8</sup>



**241101**  
**SUCRIER**  
 SUGAR BOWL  
 15 cl 5 oz<sup>1/16</sup>  
 H 10,8 cm H 4 in<sup>1/4</sup>

## PLATINE - SILVER



**203238**  
**TASSE À ESPRESSO**  
 ESPRESSO CUP  
 10 cl 3 oz<sup>3/8</sup>  
 H 6 cm H 2 in<sup>3/8</sup>  
 Ø 5,5 cm Ø 2 in<sup>3/16</sup>



**247600**  
**TASSE À THÉ / LUNGO**  
 TEA / LUNGO CUP  
 25 cl 8 oz<sup>7/16</sup>  
 H 6 cm H 2 in<sup>3/8</sup>  
 Ø 8,5 cm Ø 3 in<sup>3/8</sup>



**203242**  
**TASSE À DÉJEUNER**  
 BREAKFAST CUP  
 34 cl 11 oz<sup>1/2</sup>  
 H 7 cm H 2 in<sup>3/4</sup>  
 Ø 9,8 cm Ø 3 in<sup>7/8</sup>

**203239**  
**SOUCOUPE À ESPRESSO**  
 ESPRESSO SAUCER  
 Ø 12,5 cm Ø 4 in<sup>15/16</sup>

**203241**  
**SOUCOUPE À THÉ / LUNGO**  
 TEA / LUNGO SAUCER  
 Ø 15 cm Ø 5 in<sup>7/8</sup>

**203243**  
**SOUCOUPE À DÉJEUNER**  
 BREAKFAST SAUCER  
 Ø 18 cm Ø 7 in<sup>1/16</sup>



**203245**  
**THÉIÈRE**  
 TEA POT  
 100 cl 33 oz<sup>13/16</sup>  
 H 15,7 cm H 6 in<sup>3/16</sup>  
 Ø 12,4 cm Ø 4 in<sup>7/8</sup>



**203250**  
**SUCRIER**  
 SUGAR BOWL  
 15 cl 5 oz<sup>1/16</sup>  
 H 10,8 cm H 4 in<sup>1/4</sup>  
 Ø 9,2 cm Ø 3 in<sup>5/8</sup>



PEINT À LA MAIN  
 HAND PAINTED



# BORÉAL

MADE IN EUROPE 

## BORÉAL



**186791**  
**TASSE À ESPRESSO**  
 ESPRESSO CUP  
 9 cl 3 oz<sup>1/16</sup>  
 H 6,6 cm H 2 in<sup>5/8</sup>  
 Ø 6,7 cm Ø 2 in<sup>5/8</sup>

**186792**  
**SOUCOUPE À ESPRESSO**  
 OVALE  
 OVAL ESPRESSO SAUCER  
 L 14 cm L 5 in<sup>1/2</sup>  
 l 12 cm W 4 in<sup>3/4</sup>



**186793**  
**TASSE À THÉ / LUNGO**  
 TEA / LUNGO CUP  
 15 cl 5 oz<sup>1/16</sup>  
 H 6,8 cm H 2 in<sup>11/16</sup>  
 Ø 8,1 cm Ø 3 in<sup>3/16</sup>

**186794**  
**SOUCOUPE À THÉ / LUNGO**  
 OVALE  
 OVAL TEA / LUNGO SAUCER  
 L 16,5 cm L 6 in<sup>1/2</sup>  
 l 14 cm W 5 in<sup>1/2</sup>



**186795**  
**TASSE À DÉJEUNER**  
 BREAKFAST CUP  
 40 cl 13 oz<sup>1/2</sup>  
 H 7,5 cm H 2 in<sup>15/16</sup>  
 Ø 10,6 cm Ø 4 in<sup>3/16</sup>

**186796**  
**SOUCOUPE À DÉJEUNER**  
 OVALE  
 OVAL BREAKFAST SAUCER  
 L 20 cm L 7 in<sup>7/8</sup>  
 l 17 cm W 6 in<sup>11/16</sup>

## BORÉAL SATIN



**186791**  
**TASSE À ESPRESSO**  
 ESPRESSO CUP  
 9 cl 3 oz<sup>1/16</sup>  
 H 6,6 cm H 2 in<sup>5/8</sup>  
 Ø 6,7 cm Ø 2 in<sup>5/8</sup>

**193321**  
**SOUCOUPE À ESPRESSO**  
 OVALE  
 OVAL ESPRESSO SAUCER  
 L 14 cm L 5 in<sup>1/2</sup>  
 l 12 cm W 4 in<sup>3/4</sup>



**186793**  
**TASSE À THÉ / LUNGO**  
 TEA / LUNGO CUP  
 15 cl 5 oz<sup>1/16</sup>  
 H 6,8 cm H 2 in<sup>11/16</sup>  
 Ø 8,1 cm Ø 3 in<sup>3/16</sup>

**193322**  
**SOUCOUPE À THÉ / LUNGO**  
 OVALE  
 OVAL TEA / LUNGO SAUCER  
 L 16,5 cm L 6 in<sup>1/2</sup>  
 l 14 cm W 5 in<sup>1/2</sup>



**186795**  
**TASSE À DÉJEUNER**  
 BREAKFAST CUP  
 40 cl 13 oz<sup>1/2</sup>  
 H 7,5 cm H 2 in<sup>15/16</sup>  
 Ø 10,6 cm Ø 4 in<sup>3/16</sup>

**193323**  
**SOUCOUPE À DÉJEUNER**  
 OVALE  
 OVAL BREAKFAST SAUCER  
 L 20 cm L 7 in<sup>7/8</sup>  
 l 17 cm W 6 in<sup>11/16</sup>





# COURONNE

MADE IN EUROPE 

## DORÉE - GOLD



**207756**  
**TASSE À ESPRESSO**  
 ESPRESSO CUP  
 10 cl 3 oz<sup>3/8</sup>  
 H 5,9 cm H 2 in<sup>5/16</sup>  
 Ø 5,8 cm Ø 2 in<sup>5/16</sup>

**247345**  
**SOUCOUPE À ESPRESSO**  
 ESPRESSO SAUCER  
 Ø 12,6 cm Ø 4 in<sup>15/16</sup>



**207757**  
**TASSE À THÉ / LUNGO**  
 TEA / LUNGO CUP  
 20 cl 6 oz<sup>3/4</sup>  
 H 5,8 cm H 2 in<sup>5/16</sup>  
 Ø 8,4 cm Ø 3 in<sup>5/16</sup>

**247346**  
**SOUCOUPE À THÉ / LUNGO**  
 TEA / LUNGO SAUCER  
 Ø 15,8 cm Ø 6 in<sup>1/4</sup>



**207758**  
**TASSE À DÉJEUNER**  
 BREAKFAST CUP  
 40 cl 13 oz<sup>1/2</sup>  
 H 7,4 cm H 2 in<sup>15/16</sup>  
 Ø 10,3 cm Ø 4 in<sup>1/16</sup>

**247347**  
**SOUCOUPE À DÉJEUNER**  
 BREAKFAST SAUCER  
 Ø 18 cm Ø 7 in<sup>1/16</sup>

## ARGENTÉE - SILVER



**207756**  
**TASSE À ESPRESSO**  
 ESPRESSO CUP  
 10 cl 3 oz<sup>3/8</sup>  
 H 5,9 cm H 2 in<sup>5/16</sup>  
 Ø 5,8 cm Ø 2 in<sup>5/16</sup>

**247341**  
**SOUCOUPE À ESPRESSO**  
 ESPRESSO SAUCER  
 Ø 12,6 cm Ø 4 in<sup>15/16</sup>



**207757**  
**TASSE À THÉ / LUNGO**  
 TEA / LUNGO CUP  
 20 cl 6 oz<sup>3/4</sup>  
 H 5,8 cm H 2 in<sup>5/16</sup>  
 Ø 8,4 cm Ø 3 in<sup>5/16</sup>

**247342**  
**SOUCOUPE À THÉ / LUNGO**  
 TEA / LUNGO SAUCER  
 Ø 15,8 cm Ø 6 in<sup>1/4</sup>



**207758**  
**TASSE À DÉJEUNER**  
 BREAKFAST CUP  
 40 cl 13 oz<sup>1/2</sup>  
 H 7,4 cm H 2 in<sup>15/16</sup>  
 Ø 10,3 cm Ø 4 in<sup>1/16</sup>

**247343**  
**SOUCOUPE À DÉJEUNER**  
 BREAKFAST SAUCER  
 Ø 18 cm Ø 7 in<sup>1/16</sup>





# GRAPHIQUE

MADE IN EUROPE 

## BLANC - WHITE



**207756**  
TASSE À ESPRESSO  
ESPRESSO CUP  
10 cl 3 oz<sup>2/8</sup>  
H 5,9 cm H 2 in<sup>5/16</sup>  
Ø 5,8 cm Ø 2 in<sup>5/16</sup>

**246162**  
SOUCOUBE À ESPRESSO  
ESPRESSO SAUCER  
Ø 12,6 cm Ø 4 in<sup>15/16</sup>



**207757**  
TASSE À THÉ / LUNGO  
TEA / LUNGO CUP  
20 cl 6 oz<sup>3/4</sup>  
H 5,8 cm H 2 in<sup>5/16</sup>  
Ø 8,4 cm Ø 3 in<sup>5/16</sup>

**246163**  
SOUCOUBE À THÉ / LUNGO  
TEA / LUNGO SAUCER  
Ø 15 cm Ø 5 in<sup>7/8</sup>



**207758**  
TASSE À DÉJEUNER  
BREAKFAST CUP  
40 cl 13 oz<sup>1/2</sup>  
H 7,4 cm H 2 in<sup>15/16</sup>  
Ø 10,3 cm Ø 4 in<sup>1/16</sup>

**246268**  
SOUCOUBE À DÉJEUNER  
BREAKFAST SAUCER  
Ø 18 cm Ø 7 in<sup>1/16</sup>

## DORÉ - GOLD



**207756**  
TASSE À ESPRESSO  
ESPRESSO CUP  
10 cl 3 oz<sup>2/8</sup>  
H 5,9 cm H 2 in<sup>5/16</sup>  
Ø 5,8 cm Ø 2 in<sup>5/16</sup>

**246164**  
SOUCOUBE À ESPRESSO  
ESPRESSO SAUCER  
Ø 12,6 cm Ø 4 in<sup>15/16</sup>



**207757**  
TASSE À THÉ / LUNGO  
TEA / LUNGO CUP  
20 cl 6 oz<sup>3/4</sup>  
H 5,8 cm H 2 in<sup>5/16</sup>  
Ø 8,4 cm Ø 3 in<sup>5/16</sup>

**246165**  
SOUCOUBE À THÉ / LUNGO  
TEA / LUNGO SAUCER  
Ø 15 cm Ø 5 in<sup>7/8</sup>



**207758**  
TASSE À DÉJEUNER  
BREAKFAST CUP  
40 cl 13 oz<sup>1/2</sup>  
H 7,4 cm H 2 in<sup>15/16</sup>  
Ø 10,3 cm Ø 4 in<sup>1/16</sup>

**246269**  
SOUCOUBE À DÉJEUNER  
BREAKFAST SAUCER  
Ø 18 cm Ø 7 in<sup>1/16</sup>





# NEWPORT

MADE IN EUROPE 



**207756**  
**TASSE À ESPRESSO**  
ESPRESSO CUP  
10 cl 3 oz<sup>3/8</sup>  
H 5,9 cm H 2 in<sup>5/16</sup>  
Ø 5,8 cm Ø 2 in<sup>5/16</sup>



**207757**  
**TASSE À THÉ / LUNGO**  
TEA / LUNGO CUP  
20 cl 6 oz<sup>3/4</sup>  
H 5,8 cm H 2 in<sup>5/16</sup>  
Ø 8,4 cm Ø 3 in<sup>5/16</sup>



**207758**  
**TASSE À DÉJEUNER**  
BREAKFAST CUP  
40 cl 13 oz<sup>1/2</sup>  
H 7,4 cm H 2 in<sup>15/16</sup>  
Ø 10,3 cm Ø 4 in<sup>1/16</sup>

**207759**  
**SOUCOUPE À ESPRESSO**  
ESPRESSO SAUCER  
Ø 12,6 cm Ø 4 in<sup>15/16</sup>

**207760**  
**SOUCOUPE À THÉ / LUNGO**  
TEA / LUNGO SAUCER  
Ø 15 cm Ø 5 in<sup>7/8</sup>

**207761**  
**SOUCOUPE À DÉJEUNER**  
BREAKFAST SAUCER  
Ø 18 cm Ø 7 in<sup>1/16</sup>



**207764**  
**VERSEUSE**  
COFFEE / TEA POT  
80 cl 27 oz<sup>1/16</sup>  
H 15,6 cm H 6 in<sup>1/8</sup>



**207763**  
**VERSEUSE**  
COFFEE / TEA POT  
40 cl 13 oz<sup>1/2</sup>  
H 13,1 cm H 5 in<sup>3/16</sup>



**210912**  
**COUVERCLE DE VERSEUSE**  
COFFEE / TEA POT LID  
80 cl 27 oz<sup>1/16</sup>  
Ø 8,4 cm Ø 3 in<sup>5/16</sup>



**210911**  
**COUVERCLE DE VERSEUSE**  
COFFEE / TEA POT LID  
40 cl 13 oz<sup>1/2</sup>  
Ø 6,6 cm Ø 2 in<sup>5/8</sup>



**207762**  
**CRÉMIER**  
CREAM JUG  
10 cl 3 oz<sup>3/8</sup>  
H 8,8 cm H 3 in<sup>7/16</sup>



**247354** **NEW**  
**MUG**  
20 cl 6 oz<sup>3/4</sup>  
Ø 9,1 cm Ø 3 in<sup>9/16</sup>



**247355** **NEW**  
**MUG**  
50 cl 16 oz<sup>15/16</sup>  
Ø 13,5 cm Ø 5 in<sup>5/16</sup>





# MODULO NATURE

## BLEU GALET - BLUE



**225351**  
TASSE À ESPRESSO  
ESPRESSO CUP  
11,5 cl 3 oz<sup>7/8</sup>  
H 6 cm H 2 in<sup>3/8</sup>  
Ø 6,8 cm Ø 2 in<sup>11/16</sup>

**225352**  
SOUCOUBE À ESPRESSO  
ESPRESSO SAUCER  
Ø 12,5 cm Ø 4 in<sup>15/16</sup>

## JADE - JADE GREEN



**235690**  
TASSE À ESPRESSO  
ESPRESSO CUP  
11,5 cl 3 oz<sup>7/8</sup>  
H 6 cm H 2 in<sup>3/8</sup>  
Ø 6,8 cm Ø 2 in<sup>11/16</sup>

**235691**  
SOUCOUBE À ESPRESSO  
ESPRESSO SAUCER  
Ø 12,5 cm Ø 4 in<sup>15/16</sup>

## KAOLIN - KAOLIN



**184081**  
TASSE À ESPRESSO  
ESPRESSO CUP  
11,5 cl 3 oz<sup>7/8</sup>  
H 6 cm H 2 in<sup>3/8</sup>  
Ø 6,8 cm Ø 2 in<sup>11/16</sup>

**184082**  
SOUCOUBE À ESPRESSO  
ESPRESSO SAUCER  
Ø 12,5 cm Ø 4 in<sup>15/16</sup>

## PIERRE DE LAVE - LAVA STONE / OMBRE D'OMBRE - TAUPE



**194459**  
TASSE À ESPRESSO  
ESPRESSO CUP  
11,5 cl 3 oz<sup>7/8</sup>  
H 6 cm H 2 in<sup>3/8</sup>  
Ø 6,8 cm Ø 2 in<sup>11/16</sup>

**194460**  
SOUCOUBE À ESPRESSO  
ESPRESSO SAUCER  
Ø 12,5 cm Ø 4 in<sup>15/16</sup>



**184094**  
TASSE À ESPRESSO  
ESPRESSO CUP  
11,5 cl 3 oz<sup>7/8</sup>  
H 6 cm H 2 in<sup>3/8</sup>  
Ø 6,8 cm Ø 2 in<sup>11/16</sup>

**184095**  
SOUCOUBE À ESPRESSO  
ESPRESSO SAUCER  
Ø 12,5 cm Ø 4 in<sup>15/16</sup>



**230167**  
TASSE À THÉ / LUNGO  
TEA / LUNGO CUP  
25 cl 8 oz<sup>7/16</sup>  
H 7,5 cm H 2 in<sup>15/16</sup>  
Ø 8,8 cm Ø 3 in<sup>7/16</sup>

**230168**  
SOUCOUBE À THÉ / LUNGO  
TEA / LUNGO SAUCER  
Ø 15,9 cm Ø 6 in<sup>1/4</sup>



**235692**  
TASSE À THÉ / LUNGO  
TEA / LUNGO CUP  
25 cl 8 oz<sup>7/16</sup>  
H 7,5 cm H 2 in<sup>15/16</sup>  
Ø 8,8 cm Ø 3 in<sup>7/16</sup>

**235693**  
SOUCOUBE À THÉ / LUNGO  
TEA / LUNGO SAUCER  
Ø 15,9 cm Ø 6 in<sup>1/4</sup>



**230163**  
TASSE À THÉ / LUNGO  
TEA / LUNGO CUP  
25 cl 8 oz<sup>7/16</sup>  
H 7,5 cm H 2 in<sup>15/16</sup>  
Ø 8,8 cm Ø 3 in<sup>7/16</sup>

**230164**  
SOUCOUBE À THÉ / LUNGO  
TEA / LUNGO SAUCER  
Ø 15,9 cm Ø 6 in<sup>1/4</sup>



**230093**  
TASSE À THÉ / LUNGO  
TEA / LUNGO CUP  
25 cl 8 oz<sup>7/16</sup>  
H 7,5 cm H 2 in<sup>15/16</sup>  
Ø 8,8 cm Ø 3 in<sup>7/16</sup>

**230094**  
SOUCOUBE À THÉ / LUNGO  
TEA / LUNGO SAUCER  
Ø 15,9 cm Ø 6 in<sup>1/4</sup>



**230165**  
TASSE À THÉ / LUNGO  
TEA / LUNGO CUP  
25 cl 8 oz<sup>7/16</sup>  
H 7,5 cm H 2 in<sup>15/16</sup>  
Ø 8,8 cm Ø 3 in<sup>7/16</sup>

**230166**  
SOUCOUBE À THÉ / LUNGO  
TEA / LUNGO SAUCER  
Ø 15,9 cm Ø 6 in<sup>1/4</sup>



**246746**  
MUG  
33 cl 11 oz<sup>3/16</sup>  
H 10 cm H 3 in<sup>15/16</sup>



**246420**  
MUG  
33 cl 11 oz<sup>3/16</sup>  
H 10 cm H 3 in<sup>15/16</sup>



**184083**  
MUG  
33 cl 11 oz<sup>3/16</sup>  
H 10 cm H 3 in<sup>15/16</sup>



**194461**  
MUG  
33 cl 11 oz<sup>3/16</sup>  
H 10 cm H 3 in<sup>15/16</sup>



**184096**  
MUG  
33 cl 11 oz<sup>3/16</sup>  
H 10 cm H 3 in<sup>15/16</sup>





## LES VERRES

Nos collections de verres invitent à la convivialité et à la dégustation. Résistants et raffinés, ils accompagnent toutes les occasions avec élégance. Nos verres à pied en cristallin, comme Allure, Muse ou Domaine, sont fabriqués en Europe et proposent un style intemporel et raffiné. Nos gobelets colorés, teintés dans la masse, comme Allegro et Mambo, apportent une touche de caractère à vos tables et résistent au temps. Une alliance parfaite entre esthétique et fonctionnalité.

## GLASSWARE

*Our glassware collections invite conviviality and tasting. Both durable and refined, they accompany every occasion with elegance. Our crystal stemware, such as Allure, Muse, and Domaine, is crafted in Europe and offers a timeless, sophisticated style. Our colored tumblers, tinted throughout the material, like Allegro and Mambo, bring a touch of character to your tables and stand the test of time. A perfect alliance of aesthetics and functionality.*

A stylized logo consisting of the lowercase letters 'g' and 'd' in a red, cursive script. The 'g' is connected to the 'd', and there is a horizontal line under the 'd'.



LES VERRES À PIED  
STEMMED GLASSES

ALLURE.....	223
ANYTIME .....	225
ORIGINE .....	225
DOMAINE .....	227
GALATÉE.....	229
MONTMARTRE .....	231
HYPNOTIC.....	231
MUSE .....	233





# ALLURE

MADE IN EUROPE 



**242793**  
**FLÛTE À CHAMPAGNE**  
CHAMPAGNE FLUTE  
26 cl 8 oz<sup>13/16</sup>  
H 24,5 cm H 9 in<sup>5/8</sup>  
Ø 7,2 cm Ø 2 in<sup>13/16</sup>



**242792**  
**VERRE À VIN**  
WINE GLASS  
40,5 cl 13 oz<sup>11/16</sup>  
H 24,4 cm H 9 in<sup>5/8</sup>  
Ø 8,3 cm Ø 3 in<sup>1/4</sup>



**242791**  
**VERRE À VIN**  
WINE GLASS  
57 cl 19 oz<sup>1/4</sup>  
H 25 cm H 9 in<sup>13/16</sup>  
Ø 9,6 cm Ø 3 in<sup>3/4</sup>



**242790**  
**VERRE À BORDEAUX**  
BORDEAUX GLASS  
64,5 cl 21 oz<sup>13/16</sup>  
H 25,5 cm H 10 in<sup>1/16</sup>  
Ø 10,2 cm Ø 4 in



**242789**  
**VERRE À BOURGOGNE**  
BURGUNDY GLASS  
71 cl 24 oz  
H 24,5 cm H 9 in<sup>5/8</sup>  
Ø 11,6 cm Ø 4 in<sup>9/16</sup>



**242795**  
**GOBELET HAUT**  
HIGH TUMBLER  
39 cl 13 oz<sup>2/16</sup>  
H 14,4 cm H 5 in<sup>11/16</sup>  
Ø 7 cm Ø 2 in<sup>3/4</sup>



**242794**  
**GOBELET BAS**  
LOW TUMBLER  
47 cl 15 oz<sup>7/8</sup>  
H 10,8 cm H 4 in<sup>1/4</sup>  
Ø 9,1 cm Ø 3 in<sup>9/16</sup>





# ANYTIME

MADE IN EUROPE 



**184567**  
**FLÛTE À CHAMPAGNE**  
CHAMPAGNE FLÛTE  
15 cl 5 oz<sup>1/16</sup>  
H 19,3 cm H 7 in<sup>5/8</sup>  
Ø 6,3 cm Ø 2 in<sup>1/2</sup>



**184597**  
**FLÛTE À CHAMPAGNE**  
CHAMPAGNE FLÛTE  
21 cl 7 oz<sup>1/8</sup>  
H 20,5 cm H 8 in<sup>1/16</sup>  
Ø 6,8 cm Ø 2 in<sup>11/16</sup>



**210281**  
**COUPE À CHAMPAGNE**  
CHAMPAGNE CUP  
23 cl 7 oz<sup>3/4</sup>  
H 14,7 cm H 5 in<sup>13/16</sup>  
Ø 9,5 cm Ø 3 in<sup>3/4</sup>



**195628**  
**VERRE À MARTINI**  
MARTINI GLASS  
25 cl 8 oz<sup>7/16</sup>  
H 16,8 cm H 6 in<sup>5/8</sup>  
Ø 10,6 cm Ø 4 in<sup>3/16</sup>



**184570**  
**VERRE À COGNAC**  
BRANDY GLASS  
61 cl 20 oz<sup>5/8</sup>  
H 15,5 cm H 6 in<sup>1/8</sup>  
Ø 10,4 cm Ø 4 in<sup>1/8</sup>



# ORIGINE

  
MADE IN FRANCE



**216734\***  
**VERRE À VIN N°5**  
WINE GLASS N°5  
20 cl 6 oz<sup>3/4</sup>  
H 20 cm H 7 in<sup>7/8</sup>  
Ø 6,9 cm Ø 2 in<sup>11/16</sup>



\*ARRÊT À ÉPUISEMENT DES STOCKS  
UNTIL STOCK LIMITED



# DOMAINE

MADE IN EUROPE 



**184566**  
**FLÛTE À CHAMPAGNE**  
CHAMPAGNE FLUTE  
19 cl 6 oz<sup>7/16</sup>  
H 21,9 cm H 8 in<sup>5/8</sup>  
Ø 5,3 cm Ø 2 in<sup>1/16</sup>



**184561**  
**VERRE À EAU**  
WATER GLASS  
49,5 cl 16 oz<sup>3/4</sup>  
H 22,7 cm H 8 in<sup>15/16</sup>  
Ø 8,6 cm Ø 3 in<sup>3/8</sup>



**184562**  
**VERRE À VIN**  
WINE GLASS  
37 cl 12 oz<sup>1/2</sup>  
H 21,4 cm H 8 in<sup>7/16</sup>  
Ø 7,7 cm Ø 3 in<sup>1/16</sup>



**184564**  
**VERRE À BORDEAUX**  
BORDEAUX GLASS  
65 cl 22 oz  
H 23,9 cm H 9 in<sup>7/16</sup>  
Ø 9,4 cm Ø 3 in<sup>11/16</sup>



**184565**  
**VERRE À BOURGOGNE**  
BURGUNDY GLASS  
75 cl 25 oz<sup>3/8</sup>  
H 22,5 cm H 8 in<sup>7/8</sup>  
Ø 10,7 cm Ø 4 in<sup>3/16</sup>





# GALATÉE

MADE IN EUROPE 



**184556**  
**FLÛTE À CHAMPAGNE**  
CHAMPAGNE FLÛTE  
20 cl 6 oz<sup>2/4</sup>  
H 21,2 cm H 8 in<sup>3/8</sup>  
Ø 6,7 cm Ø 2 in<sup>5/8</sup>



**190537**  
**VERRE À VIN**  
WINE GLASS  
35 cl 11 oz<sup>13/16</sup>  
H 19,6 cm H 7 in<sup>11/16</sup>  
Ø 7,8 cm Ø 3 in<sup>1/16</sup>



**190536**  
**VERRE À VIN**  
WINE GLASS  
45 cl 15 oz<sup>3/16</sup>  
H 20,5 cm H 8 in<sup>1/16</sup>  
Ø 8,4 cm Ø 3 in<sup>5/16</sup>



**190538**  
**GOBELET**  
TUMBLER  
47 cl 15 oz<sup>7/8</sup>  
H 12,1 cm H 4 in<sup>3/4</sup>  
Ø 8,5 cm Ø 3 in<sup>3/8</sup>







# MONTMARTRE

MADE IN EUROPE 



**184580**  
**FLÛTE À CHAMPAGNE**  
 CHAMPAGNE FLUTE  
 21 cl 7 oz<sup>1/8</sup>  
 H 21 cm H 8 in<sup>1/4</sup>  
 Ø 7 cm Ø 2 in<sup>3/4</sup>



**184575**  
**VERRE À EAU**  
 WATER GLASS  
 42 cl 14 oz<sup>3/16</sup>  
 H 20,5 cm H 8 in<sup>1/16</sup>  
 Ø 8,7 cm Ø 3 in<sup>7/16</sup>



**184577**  
**VERRE À VIN**  
 WINE GLASS  
 25 cl 8 oz<sup>7/16</sup>  
 H 18,4 cm H 7 in<sup>1/4</sup>  
 Ø 7,5 cm Ø 2 in<sup>15/16</sup>



**184576**  
**VERRE À VIN**  
 WINE GLASS  
 32 cl 10 oz<sup>13/16</sup>  
 H 19,8 cm H 7 in<sup>13/16</sup>  
 Ø 7,8 cm Ø 3 in<sup>1/16</sup>



**208481**  
**VERRE À VIN**  
 WINE GLASS  
 32 cl 10 oz<sup>13/16</sup>  
 H 19,8 cm H 7 in<sup>13/16</sup>  
 Ø 7,8 cm Ø 3 in<sup>1/16</sup>



**184579**  
**VERRE À BOURGOGNE**  
 BURGUNDY GLASS  
 58 cl 19 oz<sup>5/8</sup>  
 H 20 cm H 7 in<sup>7/8</sup>  
 Ø 10 cm Ø 3 in<sup>15/16</sup>



# HYPNOTIC

MADE IN EUROPE 



**213816**  
**VERRE À VIN**  
 WINE GLASS  
 36,5 cl 12 oz<sup>5/16</sup>  
 H 22 cm H 8 in<sup>11/16</sup>  
 Ø 8,2 cm Ø 3 in<sup>1/4</sup>





# MUSE

MADE IN EUROPE 



**184551**  
**FLÛTE À CHAMPAGNE**  
 CHAMPAGNE FLUTE  
 19 cl 6 oz<sup>7/16</sup>  
 H 22,4 cm H 8 in<sup>13/16</sup>  
 Ø 6,3 cm Ø 2 in<sup>1/2</sup>



**184547**  
**VERRE À EAU**  
 WATER GLASS  
 45 cl 15 oz<sup>3/16</sup>  
 H 22,5 cm H 8 in<sup>7/8</sup>  
 Ø 8,4 cm Ø 3 in<sup>5/16</sup>



**184549**  
**VERRE À VIN**  
 WINE GLASS  
 28 cl 9 oz<sup>7/16</sup>  
 H 20,8 cm H 8 in<sup>3/16</sup>  
 Ø 7,4 cm Ø 2 in<sup>15/16</sup>



**184548**  
**VERRE À VIN**  
 WINE GLASS  
 35 cl 11 oz<sup>13/16</sup>  
 H 21,4 cm H 8 in<sup>7/16</sup>  
 Ø 8 cm Ø 3 in<sup>1/8</sup>



**184550**  
**VERRE À BORDEAUX**  
 BORDEAUX GLASS  
 64,5 cl 21 oz<sup>13/16</sup>  
 H 23,8 cm H 9 in<sup>3/8</sup>  
 Ø 9,5 cm Ø 3 in<sup>3/4</sup>



**210812**  
**VERRE À BOURGOGNE**  
 BURGUNDY GLASS  
 70 cl 23 oz<sup>11/16</sup>  
 H 23,1 cm H 9 in<sup>1/8</sup>  
 Ø 10,5 cm Ø 4 in<sup>1/8</sup>



**184555**  
**GOBELET HAUT**  
 HIGH TUMBLER  
 36 cl 12 oz<sup>3/16</sup>  
 H 14,2 cm H 5 in<sup>9/16</sup>  
 Ø 6,8 cm Ø 2 in<sup>11/16</sup>



**184554**  
**GOBELET BAS**  
 LOW TUMBLER  
 33 cl 11 oz<sup>3/16</sup>  
 H 10,2 cm H 4 in  
 Ø 8 cm Ø 3 in<sup>1/8</sup>



**184553**  
**GOBELET BAS**  
 LOW TUMBLER  
 23 cl 7 oz<sup>3/4</sup>  
 H 9,2 cm H 3 in<sup>5/8</sup>  
 Ø 7,6 cm Ø 3 in





LES GOBELETS & LES CARAFES  
TUMBLERS & CARAFES

ALLEGRO .....	237
COSMOPOLITAIN.....	239
DOLCE .....	239
EMPILEO.....	241
INSTANT.....	243
LOOP .....	243
ROC .....	243
MAMBO .....	245
CARAFES ET DÉCANTEURS .....	247



# ALLEGRO

**AMBRE** NEW  
AMBER



**248260** NEW  
GOBELET  
TUMBLER  
29 cl      9 oz<sup>13/16</sup>  
H 9,5 cm    H 3 in<sup>3/4</sup>  
Ø 7,2 cm    Ø 2 in<sup>13/16</sup>

**ÉMERAUDE** NEW  
GREEN



**248262** NEW  
GOBELET  
TUMBLER  
29 cl      9 oz<sup>13/16</sup>  
H 9,5 cm    H 3 in<sup>3/4</sup>  
Ø 7,2 cm    Ø 2 in<sup>13/16</sup>

**VIOLET** NEW  
PURPLE



**248266** NEW  
GOBELET  
TUMBLER  
29 cl      9 oz<sup>13/16</sup>  
H 9,5 cm    H 3 in<sup>3/4</sup>  
Ø 7,2 cm    Ø 2 in<sup>13/16</sup>

**BLEU INTENSE** NEW  
DEEP BLUE



**248291** NEW  
GOBELET  
TUMBLER  
29 cl      9 oz<sup>13/16</sup>  
H 9,5 cm    H 3 in<sup>3/4</sup>  
Ø 7,2 cm    Ø 2 in<sup>13/16</sup>

**BLEU NUIT**  
BLUE



**199461**  
GOBELET  
TUMBLER  
29 cl      9 oz<sup>13/16</sup>  
H 9,5 cm    H 3 in<sup>3/4</sup>  
Ø 7,2 cm    Ø 2 in<sup>13/16</sup>

**CASSIS**  
PURPLE



**174510**  
GOBELET  
TUMBLER  
29 cl      9 oz<sup>13/16</sup>  
H 9,5 cm    H 3 in<sup>3/4</sup>  
Ø 7,2 cm    Ø 2 in<sup>13/16</sup>

**GRIS**  
GREY



**225517**  
GOBELET  
TUMBLER  
29 cl      9 oz<sup>13/16</sup>  
H 9,5 cm    H 3 in<sup>3/4</sup>  
Ø 7,2 cm    Ø 2 in<sup>13/16</sup>

**TRANSPARENT**  
TRANSPARENT



**206936**  
GOBELET  
TUMBLER  
29 cl      9 oz<sup>13/16</sup>  
H 9,5 cm    H 3 in<sup>3/4</sup>  
Ø 7,2 cm    Ø 2 in<sup>13/16</sup>

**BLANC**  
WHITE



**180939**  
GOBELET  
TUMBLER  
29 cl      9 oz<sup>13/16</sup>  
H 9,5 cm    H 3 in<sup>3/4</sup>  
Ø 7,2 cm    Ø 2 in<sup>13/16</sup>

**NOIR**  
BLACK



**180936**  
GOBELET  
TUMBLER  
29 cl      9 oz<sup>13/16</sup>  
H 9,5 cm    H 3 in<sup>3/4</sup>  
Ø 7,2 cm    Ø 2 in<sup>13/16</sup>







# COSMOPOLITAIN

MADE IN EUROPE 



**189774**  
**GOBELET BAS**  
LOW TUMBLER  
42 cl 14 oz<sup>3/16</sup>  
H 10,6 cm H 4 in<sup>3/16</sup>  
Ø 8,5 cm Ø 3 in<sup>3/8</sup>



**184586**  
**GOBELET BAS**  
LOW TUMBLER  
32 cl 10 oz<sup>13/16</sup>  
H 9,4 cm H 3 in<sup>11/16</sup>  
Ø 8 cm Ø 3 in<sup>1/8</sup>



**184589**  
**GOBELET HAUT**  
HIGH TUMBLER  
35 cl 11 oz<sup>13/16</sup>  
H 14,4 cm H 5 in<sup>11/16</sup>  
Ø 6,5 cm Ø 2 in<sup>9/16</sup>



**184588**  
**GOBELET HAUT**  
HIGH TUMBLER  
29 cl 9 oz<sup>13/16</sup>  
H 10,7 cm H 4 in<sup>3/16</sup>  
Ø 7 cm Ø 2 in<sup>3/4</sup>



# DOLCE



**169851**  
**GOBELET HAUT**  
HIGH TUMBLER  
57 cl 19 oz<sup>1/4</sup>  
H 11,5 cm H 4 in<sup>1/2</sup>  
Ø 6,7 cm Ø 2 in<sup>5/8</sup>



**169852**  
**GOBELET BAS**  
LOW TUMBLER  
43 cl 14 oz<sup>2/16</sup>  
H 10 cm H 3 in<sup>15/16</sup>  
Ø 6,1 cm Ø 2 in<sup>3/8</sup>





# EMPILEO

**TRANSPARENT**  
TRANSPARENT



**234149**  
**VERRE À VIN**  
WINE GLASS  
**26 cl** 8 oz<sup>13/16</sup>  
**H 11,1 cm** H 4 in<sup>3/8</sup>  
**Ø 7,9 cm** Ø 3 in<sup>1/8</sup>

**BLEU**  
BLUE



**236287**  
**VERRE À VIN**  
WINE GLASS  
**26 cl** 8 oz<sup>13/16</sup>  
**H 11,1 cm** H 4 in<sup>3/8</sup>  
**Ø 7,9 cm** Ø 3 in<sup>1/8</sup>

**GRIS**  
GREY



**242555**  
**VERRE À VIN**  
WINE GLASS  
**26 cl** 8 oz<sup>13/16</sup>  
**H 11,2 cm** H 4 in<sup>7/16</sup>  
**Ø 7,9 cm** Ø 3 in<sup>1/8</sup>



**234150**  
**GOBELET**  
TUMBLER  
**26 cl** 8 oz<sup>13/16</sup>  
**H 9,1 cm** H 3 in<sup>9/16</sup>  
**Ø 7,1 cm** Ø 2 in<sup>13/16</sup>



**236289**  
**GOBELET**  
TUMBLER  
**26 cl** 8 oz<sup>13/16</sup>  
**H 9,1 cm** H 3 in<sup>9/16</sup>  
**Ø 7,1 cm** Ø 2 in<sup>13/16</sup>



**242554**  
**GOBELET**  
TUMBLER  
**26 cl** 8 oz<sup>13/16</sup>  
**H 9,1 cm** H 3 in<sup>9/16</sup>  
**Ø 7,1 cm** Ø 2 in<sup>13/16</sup>



**234148**  
**CARAFE**  
**75 cl** 25 oz<sup>3/8</sup>  
**H 24 cm** H 9 in<sup>7/16</sup>  
**Ø 9,1 cm** Ø 3 in<sup>9/16</sup>



**236288**  
**CARAFE**  
**75 cl** 25 oz<sup>3/8</sup>  
**H 24 cm** H 9 in<sup>7/16</sup>  
**Ø 9,1 cm** Ø 3 in<sup>9/16</sup>





# INSTANT

MADE IN EUROPE 



**243495\***  
**GOBELET**  
**TUMBLER**  
**32 cl**      10 oz<sup>13/16</sup>  
**H 13,7 cm**    H 5 in<sup>3/8</sup>  
**Ø 6 cm**      Ø 2 in<sup>3/8</sup>



\*ARRÊT À ÉPUISEMENT DES STOCKS  
 UNTIL STOCK LIMITED

# LOOP

MADE IN EUROPE 



**184601**  
**GOBELET HAUT**  
**HIGH TUMBLER**  
**39 cl**      13 oz<sup>3/16</sup>  
**H 14,5 cm**    H 5 in<sup>11/16</sup>  
**Ø 6,6 cm**      Ø 2 in<sup>5/8</sup>



**184600**  
**GOBELET BAS**  
**LOW TUMBLER**  
**35 cl**      11 oz<sup>13/16</sup>  
**H 9,1 cm**      H 3 in<sup>9/16</sup>  
**Ø 7,9 cm**      Ø 3 in<sup>1/8</sup>



**184598**  
**GOBELET BAS**  
**LOW TUMBLER**  
**19 cl**      6 oz<sup>7/16</sup>  
**H 8,1 cm**      H 3 in<sup>3/16</sup>  
**Ø 6,7 cm**      Ø 2 in<sup>5/8</sup>



# ROC



**236339**  
**GOBELET HAUT**  
**HIGH TUMBLER**  
**45 cl**      15 oz<sup>3/16</sup>  
**H 14 cm**      H 5 in<sup>1/2</sup>  
**Ø 7,2 cm**      Ø 2 in<sup>13/16</sup>



**236340**  
**GOBELET BAS**  
**LOW TUMBLER**  
**27 cl**      9 oz<sup>1/8</sup>  
**H 11,5 cm**    H 4 in<sup>1/2</sup>  
**Ø 7,2 cm**      Ø 2 in<sup>13/16</sup>



**236338**  
**GOBELET BAS**  
**LOW TUMBLER**  
**18 cl**      6 oz<sup>1/16</sup>  
**H 6,5 cm**      H 2 in<sup>9/16</sup>  
**Ø 7,2 cm**      Ø 2 in<sup>13/16</sup>





# MAMBO

**AMBRE** NEW  
AMBER



**248208** NEW  
GOBELET  
TUMBLER  
34 cl 11 oz<sup>1/2</sup>  
H 10 cm H 3 in<sup>15/16</sup>  
Ø 8,5 cm Ø 3 in<sup>3/8</sup>

**ÉMERAUDE** NEW  
EMERALD



**248210** NEW  
GOBELET  
TUMBLER  
34 cl 11 oz<sup>1/2</sup>  
H 10 cm H 3 in<sup>15/16</sup>  
Ø 8,5 cm Ø 3 in<sup>3/8</sup>

**VIOLET** NEW  
PURPLE



**248216** NEW  
GOBELET  
TUMBLER  
34 cl 11 oz<sup>1/2</sup>  
H 10 cm H 3 in<sup>15/16</sup>  
Ø 8,5 cm Ø 3 in<sup>3/8</sup>

**BLEU INTENSE** NEW  
DEEP BLUE



**248206** NEW  
GOBELET  
TUMBLER  
34 cl 11 oz<sup>1/2</sup>  
H 10 cm H 3 in<sup>15/16</sup>  
Ø 8,5 cm Ø 3 in<sup>3/8</sup>

**GRIS**  
GREY



**171631**  
GOBELET  
TUMBLER  
34 cl 11 oz<sup>1/2</sup>  
H 10 cm H 3 in<sup>15/16</sup>  
Ø 8,5 cm Ø 3 in<sup>3/8</sup>

**ROUGE**  
RED



**171630**  
GOBELET  
TUMBLER  
34 cl 11 oz<sup>1/2</sup>  
H 10 cm H 3 in<sup>15/16</sup>  
Ø 8,5 cm Ø 3 in<sup>3/8</sup>

**VERT**  
GREEN



**171632**  
GOBELET  
TUMBLER  
34 cl 11 oz<sup>1/2</sup>  
H 10 cm H 3 in<sup>15/16</sup>  
Ø 8,5 cm Ø 3 in<sup>3/8</sup>

**TRANSPARENT**  
TRANSPARENT



**248214**  
GOBELET  
TUMBLER  
34 cl 11 oz<sup>1/2</sup>  
H 10 cm H 3 in<sup>15/16</sup>  
Ø 8,5 cm Ø 3 in<sup>3/8</sup>







# CARAFES ET DÉCANTEURS

**EMPILEO**  
TRANSPARENT  
TRANSPARENT



**234148**  
CARAFE  
75 cl 25 oz<sup>3/8</sup>  
H 24 cm H 9 in<sup>7/16</sup>  
Ø 9,1 cm Ø 3 in<sup>9/16</sup>

**BLEU**  
BLUE



**236288**  
CARAFE  
75 cl 25 oz<sup>3/8</sup>  
H 24 cm H 9 in<sup>7/16</sup>  
Ø 9,1 cm Ø 3 in<sup>9/16</sup>

**EVENTO**



**202639**  
CARAFE  
120 cl 40 oz<sup>9/16</sup>  
H 27,5 cm H 10 in<sup>13/16</sup>  
Ø 10,5 cm Ø 4 in<sup>1/8</sup>



**202855**  
BOUCHON DE CARAFE SILICONE  
STOPPER FOR CARAFE SILICONE  
H 4,2 cm H 1 in<sup>5/8</sup>  
Ø 6,5 cm Ø 2 in<sup>9/16</sup>

**MILLÉSIME**



**169728**  
DÉCANTEUR  
DECANTER  
135 cl 45 oz<sup>5/8</sup>  
H 23,5 cm H 9 in<sup>1/4</sup>  
Ø 20,5 cm Ø 8 in<sup>1/16</sup>

**NECTAR**



**210904**  
DÉCANTEUR  
DECANTER  
100 cl 33 oz<sup>13/16</sup>  
H 24,5 cm H 9 in<sup>5/8</sup>  
Ø 13,5 cm Ø 5 in<sup>5/16</sup>





## LA PLATERIE

À travers nos collections de platerie, Guy Degrenne exprime toute la richesse de son savoir-faire d'orfèvre. Des pièces dédiées à la table, au service et à la dégustation, conçues pour allier qualité, élégance et précision. Chaque création reflète notre exigence et notre passion pour l'art de recevoir. Ces collections, dont notre iconique Newport, peuvent être proposées en finition métal argenté, une finition réalisée dans notre Manufacture de Vire en Normandie.

## HOLLOWARE

*Through our holloware collections, Guy Degrenne showcases the full richness of its highly varied metal-working expertise. Pieces dedicated to the table, service, and tasting, designed to combine quality, elegance, and precision. Each creation reflects our high standards and passion for the art of entertaining. These collections, including our iconic Newport, are available in silver-plated finish, crafted in our Manufacture in Vire, Normandy.*





LA PLATERIE  
HOLLOWARE

NEWPORT PLATEAUX . . . . .	253
NEWPORT CUBIQUE PLATEAUX . . . . .	255
NEWPORT TABLE . . . . .	257
NEWPORT CAFÉTERIE . . . . .	259
NEWPORT BAR . . . . .	261
NEWPORT ACCESSOIRES . . . . .	263



DEGRENNE  
PARIS

# NEWPORT PLATEAUX

MADE IN FRANCE



■ 238953  
 ■ 238963  
**PLATEAU RECTANGULAIRE AVEC ANSES**  
 RECTANGULAR TRAY WITH HANDLE  
 L 77 cm L 30 in<sup>5/16</sup>  
 l 55 cm W 21 in<sup>5/8</sup>  
 INT :  
 L 68,5 cm L 26 in<sup>15/16</sup>  
 l 46,5 cm W 18 in<sup>5/16</sup>



■ 238954  
 ■ 238964  
**PLATEAU RECTANGULAIRE AVEC ANSES**  
 RECTANGULAR TRAY WITH HANDLE  
 L 65 cm L 25 in<sup>9/16</sup>  
 l 53 cm W 20 in<sup>7/8</sup>  
 INT :  
 L 56,5 cm L 22 in<sup>9/16</sup>  
 l 44,5 cm W 17 in<sup>1/2</sup>



■ 238955  
 ■ 238965  
**PLATEAU RECTANGULAIRE AVEC ANSES**  
 RECTANGULAR TRAY WITH HANDLE  
 L 60 cm L 23 in<sup>5/8</sup>  
 l 40 cm W 15 in<sup>3/4</sup>  
 INT :  
 L 51,5 cm 20 in<sup>1/4</sup>  
 l 31,5 cm 12 in<sup>3/8</sup>



■ 238962  
 ■ 238970  
**PLATEAU RECTANGULAIRE**  
 RECTANGULAR TRAY  
 L 53 cm L 20 in<sup>7/8</sup>  
 l 32,5 cm W 12 in<sup>13/16</sup>  
 INT :  
 L 46,5 cm L 18 in<sup>5/16</sup>  
 l 26 cm W 10 in<sup>1/4</sup>



■ 238961  
 ■ 238971  
**PLATEAU RECTANGULAIRE**  
 RECTANGULAR TRAY  
 L 40 cm L 15 in<sup>3/4</sup>  
 l 27 cm W 10 in<sup>5/8</sup>  
 INT :  
 L 33,5 cm L 13 in<sup>3/16</sup>  
 l 20,5 cm W 8 in<sup>1/16</sup>



■ 238960  
 ■ 238972  
**PLATEAU RECTANGULAIRE**  
 RECTANGULAR TRAY  
 L 32,5 cm L 12 in<sup>13/16</sup>  
 l 26,5 cm W 10 in<sup>7/16</sup>  
 INT :  
 L 26 cm 10 in<sup>1/4</sup>  
 l 20 cm 7 in<sup>7</sup>



■ 227767  
 ■ 227768  
**PLATEAU RECTANGULAIRE**  
 RECTANGULAR TRAY  
 L 22 cm L 8 in<sup>11/16</sup>  
 l 14 cm W 5 in<sup>1/2</sup>  
 INT :  
 20 cm 7 in<sup>7/8</sup>  
 12 cm 4 in<sup>3/4</sup>



■ 185024  
 ■ 186457  
**PLATEAU ROND**  
 ROUND TRAY  
 Ø 42 cm Ø 16 in<sup>9/16</sup>  
 Ø INT : 35,1 cm Ø 13 in<sup>13/16</sup>



■ 232972  
**PLATEAU RECTANGULAIRE**  
 RECTANGULAR TRAY  
 L 26 cm L 10 in<sup>1/4</sup>  
 l 18 cm W 7 in<sup>1/16</sup>  
 INT :  
 L 23 cm L 9 in<sup>1/16</sup>  
 l 15 cm W 5 in<sup>7/8</sup>



DEGI  
PAR



# NEWPORT CUBIQUE PLATEAUX

MADE IN FRANCE



**238987**  
**238989**  
**PLATEAU RECTANGULAIRE**  
**AVEC ANSES**  
 RECTANGULAR TRAY WITH  
 HANDLES  
 L 65 cm      L 25 in<sup>9/16</sup>  
 l 53 cm      W 20 in<sup>7/8</sup>  
 INT :  
 L 56,5 cm      L 22 in<sup>1/4</sup>  
 l 44,5 cm      W 17 in<sup>1/2</sup>

**238988**  
**238990**  
**PLATEAU RECTANGULAIRE**  
**AVEC ANSES**  
 RECTANGULAR TRAY WITH  
 HANDLES  
 L 60 cm      L 23 in<sup>5/8</sup>  
 l 40 cm      W 15 in<sup>3/4</sup>  
 INT :  
 L 51,5 cm      L 20 in<sup>1/4</sup>  
 l 31,5 cm      W 12 in<sup>3/8</sup>



**211888**  
**213859**  
**PLATEAU RECTANGULAIRE**  
 RECTANGULAR TRAY  
 L 32,5 cm      L 12 in<sup>13/16</sup>  
 l 26,5 cm      W 10 in<sup>7/16</sup>  
 INT :  
 L 26 cm      10 in<sup>1/4</sup>  
 l 20 cm      W 7 in<sup>7/8</sup>

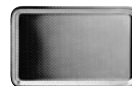

**211889**  
**213860**  
**PLATEAU RECTANGULAIRE**  
 RECTANGULAR TRAY  
 L 22 cm      L 8 in<sup>11/16</sup>  
 l 14 cm      W 5 in<sup>1/2</sup>  
 INT :  
 L 20 cm      7 in<sup>7/8</sup>  
 l 12 cm      4 in<sup>3/4</sup>



**230872**  
**230874**  
**DESSOUS DE BOUTEILLE**  
 BOTTLE COASTER  
 Ø 13,5 cm      Ø 5 in<sup>5/16</sup>



# NEWPORT TABLE

MADE IN FRANCE



■ 238958  
 ■ 238968  
**PLAT OVALE**  
 OVAL SERVING DISH  
 L 46 cm L 18 in<sup>1/8</sup>  
 l 31 cm W 12 in<sup>3/16</sup>  
 INT :  
 L 25,9 cm L 10 in<sup>3/16</sup>  
 l 13,9 cm W 5 in<sup>1/2</sup>



■ 238957  
 ■ 238967  
**PLAT OVALE**  
 OVAL SERVING DISH  
 L 41 cm L 16 in<sup>1/8</sup>  
 l 28 cm W 11 in  
 INT :  
 L 28,7 cm L 11 in<sup>5/16</sup>  
 l 15,6 cm W 6 in<sup>1/8</sup>



■ 238956  
 ■ 238966  
**PLAT OVALE**  
 OVAL SERVING DISH  
 L 38 cm L 14 in<sup>15/16</sup>  
 l 25 cm W 9 in<sup>13/16</sup>  
 INT :  
 L 26,6 cm L 10 in<sup>1/2</sup>  
 l 16,3 cm W 6 in<sup>7/16</sup>



■ 238959  
 ■ 238969  
**PLAT OVALE**  
 OVAL SERVING DISH  
 L 60 cm L 23 in<sup>5/8</sup>  
 l 27 cm W 10 in<sup>5/8</sup>  
 INT :  
 L 46,3 L 18 in<sup>1/4</sup>  
 l 14,3 CM W 5 in<sup>5/8</sup>



■ 186198  
 ■ 186456  
**SAUCIÈRE**  
 SAUCEBOAT  
 20 cl 6 oz<sup>3/4</sup>  
 L 19 cm L 7 in<sup>1/2</sup>



■ 185307  
 ■ 186455  
**BEURRIER**  
 BUTTER DISH  
 H 7 cm H 2 in<sup>3/4</sup>  
 Ø 7,6 cm Ø 3 in



190255  
**SOCLE BEURRIER PORCELAINE**  
 BASE PORCELAIN FOR BUTTER DISH



■ 211397  
**PORTE SUCRE / CENTRE DE TABLE**  
 SUGAR HOLDER/TABLE CENTERPIECE  
 H 7,5 cm H 2 in<sup>15/16</sup>  
 Ø 6,4 cm Ø 2 in<sup>1/2</sup>



# NEWPORT CAFÉTERIE

## POTS ISOTHERMES - INSULATED POTS



■ 213846  
 ☕ 219557  
**VERSEUSE ISOTHERME**  
 INSULATED COFFEE/TEAPOT  
 1,2 L 40 oz<sup>7/16</sup>



■ 213847  
 ☕ 219558  
**VERSEUSE ISOTHERME**  
 INSULATED COFFEE/TEAPOT  
 70 CL 23 oz<sup>11/16</sup>



■ 213848  
 ☕ 219559  
**VERSEUSE ISOTHERME**  
 INSULATED COFFEE/TEAPOT  
 30 CL 10 oz<sup>1/8</sup>



## VERSEUSES - COFFEE/TEA POTS



■ 213850  
 ☕ 219563  
**VERSEUSE**  
 COFFEE/TEAPOT  
 1,5 L 50 oz<sup>3/4</sup>



■ 213851  
 ☕ 219564  
**VERSEUSE**  
 COFFEE/TEAPOT  
 70 CL 23 oz<sup>11/16</sup>



■ 213852  
 ☕ 219565  
**VERSEUSE**  
 COFFEE/TEAPOT  
 35 CL 11 oz<sup>13/16</sup>



■ 213849  
 ☕ 219561  
**PICHET**  
 WATER PITCHER  
 2 L 67 oz<sup>5/8</sup>  
 H 23 cm H 9 in<sup>1/16</sup>



■ 213853  
 ☕ 219566  
**CRÉMIER**  
 CREAMER  
 35 CL 11 oz<sup>13/16</sup>



■ 213854  
 ☕ 219567  
**CRÉMIER**  
 CREAMER  
 15 CL 5 oz<sup>1/16</sup>



■ 182341  
 ☕ 184612  
**SUCRIER AVEC COUVERCLE**  
 SUGAR BOWL WITH LID  
 35 CL 11 oz<sup>13/16</sup>  
 H 6 cm H 2 in<sup>3/8</sup>

## PORCELAINE - PORCELAIN



NEWPORT  
 P. 215





# NEWPORT BAR

MADE IN FRANCE



■ 186030  
 ■ 188894  
**SEAU À CHAMPAGNE**  
 CHAMPAGNE BUCKET  
 H 21 cm H 8 in<sup>1/4</sup>  
 Ø 20 cm Ø 7 in<sup>7/8</sup>



■ 184180  
 ■ 188895  
**SEAU À CHAMPAGNE 2**  
 CHAMPAGNE BUCKET 2  
 BOUTEILLES  
 H 24 cm H 9 in<sup>7/16</sup>  
 Ø 24 cm Ø 9 in<sup>7/16</sup>



■ 185607  
 ■ 188893  
**PORTE SEAU À CHAMPAGNE**  
 CHAMPAGNE BUCKET STAND  
 H 63 cm H 24 in<sup>13/16</sup>  
 Ø 20 cm Ø 7 in<sup>7/8</sup>



■ 184181  
 ■ 188896  
**SEAU À GLACE DOUBLE PAROI**  
 DOUBLE WALL ICE BUCKET  
 H 15 cm H 5 in<sup>7/8</sup>  
 Ø 15 cm Ø 5 in<sup>7/8</sup>



■ 237501  
**RAFRAICHISSEUR DOUBLE**  
 PAROI  
 DOUBLE WALL WINE COOLER



■ 234320  
**DESSOUS DE BOUTEILLE**  
 BOTTLE COASTER  
 Ø 9,5 cm Ø 3 in<sup>3/4</sup>



■ 230872  
**DESSOUS DE BOUTEILLE**  
 BOTTLE COASTER  
 Ø 13,5 cm Ø 5 in<sup>5/16</sup>



■ 004014  
**PINCE À GLACE**  
 ICE TONG  
 L 16 cm L 6 in<sup>5/16</sup>





# NEWPORT ACCESSOIRES



■ 182614  
 ■ 184477  
**CLOCHE COUVRE ASSIETTE**  
 PLATE COVER  
 H 12,7 cm H 5 in  
 Ø 24 cm Ø 9 in<sup>7/16</sup>



■ 182301  
 ■ 184476  
**CLOCHE COUVRE ASSIETTE**  
 PLATE COVER  
 H 8,6 cm H 3 in<sup>3/8</sup>  
 Ø 15 cm Ø 5 in<sup>7/8</sup>



■ 044113  
 ■ 101512  
**CLOCHE COUVRE ASSIETTE**  
 PLATE COVER  
 Ø 26,5 cm Ø 10 in<sup>7/16</sup>



■ 044112  
 ■ 101510  
**CLOCHE COUVRE ASSIETTE**  
 PLATE COVER  
 Ø 22,5 cm Ø 8 in<sup>7/8</sup>



204043  
**CLOCHE COUVRE ASSIETTE**  
 PLATE COVER  
 Ø 16,5 cm Ø 6 in<sup>1/2</sup>

206504  
**BOUCHON CLOCHE COUVRE ASSIETTE**  
 PLATE COVER LID  
 Ø 5,2 cm Ø 2 in<sup>1/16</sup>



247581  
**CLOCHE EN VERRE**  
 GLASS DOME COVER  
 H 13 cm H 5 in<sup>1/8</sup>  
 Ø 16 cm Ø 6 in<sup>5/16</sup>



247582  
**CLOCHE EN VERRE**  
 GLASS DOME COVER  
 H 16,5 cm H 6 in<sup>1/2</sup>  
 Ø 23 cm Ø 9 in<sup>1/16</sup>



247583  
**CLOCHE EN VERRE**  
 GLASS DOME COVER  
 H 20,5 cm H 8 in<sup>1/16</sup>  
 Ø 28 cm Ø 11 in



■ 128910  
 ■ 131114  
**CORBEILLE RONDE**  
 ROUND BASKET  
 Ø 17,5 cm Ø 6 in<sup>7/8</sup>

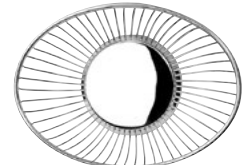

■ 128912  
 ■ 131117  
**CORBEILLE OVALE**  
 OVAL BASKET  
 L 24 cm L 9 in<sup>7/16</sup>  
 H 7,5 cm H 2 in<sup>15/16</sup>  
 l 17 cm W 6 in<sup>11/16</sup>



216920  
**VERRINE POIVRE**  
 PEPPER CELLAR  
 L 6,7 cm L 2 in<sup>5/8</sup>  
 l 4,1 cm W 1 in<sup>5/8</sup>



216919  
**VERRINE SEL**  
 SALT CELLAR  
 L 6,7 cm L 2 in<sup>5/8</sup>  
 l 4,1 cm W 1 in<sup>5/8</sup>



216922  
**SET AIMANTÉ SALIÈRE ET POIVRIER**  
 MAGNETIC SALT AND PEPPER SHAKER SET  
 H 10,6 cm H 4 in<sup>3/16</sup>  
 Ø 8,5 cm Ø 3 in<sup>3/8</sup>

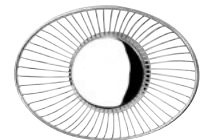

■ 128911  
 ■ 131118  
**CORBEILLE OVALE**  
 OVAL BASKET  
 L 19,5 cm L 7 in<sup>11/16</sup>  
 l 15 cm W 5 in<sup>7/8</sup>



■ 004013  
**PINCE À ESCARGOTS**  
 SNAIL TONG  
 L 16 cm L 6 in<sup>5/16</sup>



■ 184492  
**PINCE À CRUSTACÉS**  
 SHELLFISH CLAMP  
 L 16 cm L 6 in<sup>5/16</sup>



■ 204496  
 ■ 101494  
**CISEAUX À GÂTEAUX**  
 PASTRY SCISSOR  
 L 195 mm L 7 in<sup>11/16</sup>



■ 204498  
 ■ 101492  
**PINCE À PAIN**  
 BREAD TONG  
 L 231 mm L 9 in<sup>1/8</sup>



■ 204499  
 ■ 184355  
**PINCE À SERVIR**  
 SERVING TONG  
 L 295 mm L 11 in<sup>5/8</sup>



## LE BUFFET EVENTO

Du petit-déjeuner au dîner, des buffets sucrés aux buffets salés, notre collection Evento répond à tous les scénarios de réception avec élégance et fonctionnalité. Design homogène et harmonieux, hygiène parfaite, solutions modulables : chaque élément est pensé pour préserver la fraîcheur ou la chaleur des mets, tout en facilitant le service. Acier inoxydable, porcelaine, grès, verre, bois... Evento vous propose une grande richesse de combinaisons, tout en s'adaptant à votre univers et en valorisant vos buffets avec style.

## EVENTO BUFFET

*From breakfast to dinner, from sweet buffets to savory ones, our Evento collection meets every reception scenario with elegance and functionality. A consistent and harmonious design, perfect hygiene, modular solutions: every element is designed to preserve the freshness or warmth of dishes while making service easier. Stainless steel, porcelain, stoneware, glass, wood... Evento offers a wealth of combinations, adapting to your environment and enhancing your buffets with style.*

A stylized logo consisting of the letters 'gd.' in a red, cursive script font.



LE BUFFET EVENTO  
EVENTO BUFFET

CHAFING DISHES . . . . .	271
MODULES FROIDS . . . . .	273
URNE À JUS DE FRUITS . . . . .	276
DISTRIBUTEURS À CÉRÉALES . . . . .	277
SUPPORTS DE PRÉSENTATION . . . . .	280
PLANCHES LES ESSENCES . . . . .	283
ACCESSOIRES . . . . .	284
PIÈCES DÉTACHÉES . . . . .	286



# CHAFING DISHES

MADE IN FRANCE

Couvercle en verre transparent pour percevoir le contenu et rendre le buffet plus gourmand

*Clear glass cover allows contents to be viewed instantly and makes the buffet more enticing*

Charnière avec vérin et amortisseur pour un réel confort d'utilisation et une fermeture en douceur

*The hydraulic buffering hinge offers user comfort and convenience with its soft closure mechanism*

Encoches pour les couverts de service

*The notch for the serving cutlery*



Acier inoxydable, couvercle avec gouttière, verre trempé, système de récupération d'eau de condensation

*Stainless steel, lid with groove, condensation water collection system in the porcelain insert*

Compatible plaque induction, avec résistance électrique ou porte-brûleur avec gel combustible

*Compatible with induction, electrical and/or «sterno» fuel heating system*

**BAC PORCELAINE**  
PORCELAIN TRAY



**BAC INOX**  
STAINLESS STEEL TRAY



35,5 cm 14 in

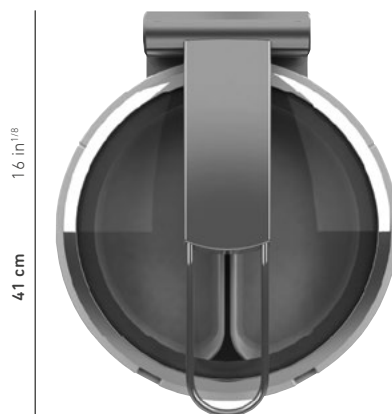

41 cm 16 in

**2 FINITIONS - FINISHES**

**MIROIR**  
MIRROR



**BROSSÉ**  
BRUSHED



Ø 35,5 cm Ø 14 in  
P 41 cm D 16 in<sup>1/8</sup>  
H 15 cm H 5 in<sup>7/8</sup>

CERTAINES PIÈCES SONT DISPONIBLES EN PIÈCES DÉTACHÉES  
SOME ITEMS ARE AVAILABLE INDIVIDUALLY





**FINITION MIROIR**  
MIRROR FINISH



**236195\***  
CHAFING DISH INOX SANS BAC + COUVERCLE AVEC  
GOUTTIÈRE EN VERRE TREMPÉ - MIROIR  
CHAFING DISH WITHOUT INSERT WITH TEMPERED GLASS  
LID WITH SS GUTTER - MIRROR FINISH

**FINITION BROSSÉE**  
BRUSHED FINISH



**236194\***  
CHAFING DISH INOX SANS BAC + COUVERCLE VERRE  
TREMPÉ AVEC GOUTTIÈRE - BROSSÉ  
CHAFING DISH WITHOUT INSERT WITH TEMPERED GLASS  
LID WITH SS GUTTER - BRUSHED FINISH



**203470**  
COUVERCLE AVEC GOUTTIÈRE ACIER - VERRE TREMPÉ  
LID WITH STAINLESS STEEL GUTTER - TEMPERED GLASS  
Ø 33 cm Ø 13 in



**203005**  
SUPPORT CHAFING DISH POUR RÉSISTANCE  
ÉLECTRIQUE OU PORTE-BRÛLEUR - MIROIR  
CHAFING STAND FOR ELECTRICAL AND/OR STERNO  
HEATING PURPOSES - MIRROR FINISH  
Ø 35 cm Ø 13 in<sup>3/4</sup>



**202859**  
SUPPORT CHAFING DISH POUR RÉSISTANCE  
ÉLECTRIQUE OU PORTE-BRÛLEUR - BROSSÉ  
CHAFING STAND FOR ELECTRICAL AND/OR STERNO  
HEATING PURPOSES - BRUSHED FINISH  
Ø 35 cm Ø 13 in<sup>3/4</sup>



**216142**  
BAC INOX POUR CHAFING DISH  
STAINLESS STEEL INSERT FOR CHAFING DISH  
3 L 101 oz<sup>7/16</sup>  
L 35,5 cm L 14 in  
H 7 cm H 2 in<sup>3/4</sup>  
l 6,3 cm W 2 in<sup>1/2</sup>  
Ø 35 cm Ø 13 in<sup>3/4</sup>



**215721**  
BAC PORCELAINE POUR CHAFING DISH  
PORCELAIN INSERT FOR CHAFING DISH  
3 L 101 oz<sup>7/16</sup>  
H 7 cm H 2 in<sup>3/4</sup>  
Ø 35 cm Ø 13 in<sup>3/4</sup>



**202635**  
1/2 BAC PORCELAINE POUR CHAFING DISH  
1/2 PORCELAIN INSERT FOR CHAFING DISH  
1 L 33 oz<sup>13/16</sup>  
L 29 cm L 11 in<sup>7/16</sup>  
H 4,5 cm H 1 in<sup>3/4</sup>  
l 15 cm W 5 in<sup>7/8</sup>  
Ø 29 cm Ø 11 in<sup>7/16</sup>



**202860**  
RÉSISTANCE AVEC RÉGULATEUR DE TEMPÉRATURE  
HEATING ELEMENT WITH ADJUSTABLE HEAT

**246341**  
RÉSISTANCE 110V/120V  
HEATING ELEMENT 110/120V HEAT AJUSTABLE 500W



**243950**  
PORTE BRULEUR POUR GEL COMBUSTIBLE  
BURNER HOLDER FOR FUEL GEL

CERTAINES PIÈCES SONT DISPONIBLES EN PIÈCES DÉTACHÉES  
SOME ITEMS ARE AVAILABLE INDIVIDUALLY

\*A COMMANDER AVEC LE BAC POUR CHAFING DISH (216142 OU 215721)  
MUST BE ORDERED WITH THE CHAFING INSERT (216142 OR 215721)



# MODULES FROIDS REFRIGERATED UNITS

56,5 cm 22 in<sup>1/4</sup>



L 56,5 cm L 22 in<sup>1/4</sup>  
P 36 cm D 14 in<sup>3/16</sup>  
H 9,5 cm H 3 in<sup>3/4</sup>

## 3 FINITIONS - FINISHES

**MIROIR**  
MIRROR



**BROSSÉ**  
BRUSHED



**NOIR MÉTALLISÉ**  
METALLIC BLACK



Le module réfrigéré reçoit une large gamme de contenants, plateaux et accessoires multi-matériaux au format GN en porcelaine, verre, acier, acrylique, mélamine pierre et mélamine bois. Ils permettent une infinité de combinaisons.

*The refrigerated unit will hold a wide range of platters and multi-material accessories in Industry standard format in porcelain, glass, steel, acrylic stone and wood melamine allowing endless combinations.*



202864<sup>(1)</sup>  
**MODULE FROID GN 1/1 - MIROIR**  
REFRIGERATED SET GN 1/1 - MIRROR FINISH  
L 56,5 cm L 22 in<sup>1/4</sup>  
H 9,5 cm H 3 in<sup>3/4</sup>  
l 36 cm W 14 in<sup>3/16</sup>



202865<sup>(1)</sup>  
**MODULE FROID GN 1/1 - BROSSÉ**  
REFRIGERATED SET GN 1/1 - BRUSHED FINISH  
L 56,5 cm L 22 in<sup>1/4</sup>  
H 9,5 cm H 3 in<sup>3/4</sup>  
l 36 cm W 14 in<sup>3/16</sup>



202869<sup>(1)</sup>  
**MODULE FROID GN 1/1 - NOIR MÉTALLISÉ**  
REFRIGERATED SET GN 1/1 - METALLIC BLACK  
L 56,5 cm L 22 in<sup>1/4</sup>  
H 9,5 cm H 3 in<sup>3/4</sup>  
l 36 cm W 14 in<sup>3/16</sup>



235356<sup>(1)</sup>  
**MODULE RÉFRIGÉRÉ GN 1/2 - MIROIR**  
REFRIGERATED SET GN 1/2 - MIRROR FINISH  
L 35,6 cm L 14 in  
l 29,5 cm W 11 in<sup>5/8</sup>



235361<sup>(1)</sup>  
**MODULE RÉFRIGÉRÉ GN 1/2 - BROSSÉ**  
REFRIGERATED SET GN 1/2 - BRUSHED FINISH  
L 35,6 cm L 14 in  
l 29,5 cm W 11 in<sup>5/8</sup>



235362<sup>(1)</sup>  
**MODULE RÉFRIGÉRÉ GN 1/2 - NOIR MÉTALLISÉ**  
REFRIGERATED SET GN 1/2 - METALLIC BLACK  
L 35,6 cm L 14 in  
l 29,5 cm W 11 in<sup>5/8</sup>



202871  
**COUVERCLE MODULE RÉFRIGÉRÉ**  
LID FOR REFRIGERATED SET  
L 56 cm L 22 in<sup>1/16</sup>  
H 19 cm H 7 in<sup>1/2</sup>  
l 35 cm W 13 in<sup>3/4</sup>



208357  
**PLAQUE EUTECTIQUE POUR MODULE FROID GN 1/1**  
EUTECTIC PLATE FOR GN 1/1 COOLING MODULE  
L 48 cm L 18 in<sup>7/8</sup>  
H 3 cm H 1 in<sup>3/16</sup>  
l 28 cm W 11 in



239786  
**PLAQUE EUTECTIQUE POUR MODULE FROID GN 1/2**  
EUTECTIC PLATE FOR GN 1/2 COOLING MODULE  
L 27 cm L 10 in<sup>5/8</sup>  
H 3 cm H 1 in<sup>3/16</sup>  
l 21 cm W 8 in<sup>1/4</sup>

CERTAINES PIÈCES SONT DISPONIBLES EN PIÈCES DÉTACHÉES  
SOME ITEMS ARE AVAILABLE INDIVIDUALLY

(1) BAC PLASTIQUE GARANTI LAVE-VAISSELLE  
PLASTIC CONTAINER DISHWASHER SAFE

# PLATEAUX POUR MODULES FROIDS

## PLATTERS FOR REFRIGERATED UNITS

MÉLAMINE BOIS<sup>(1)</sup>

WOOD MELAMINE TRAY

MÉLAMINE PIERRE<sup>(1)</sup>

STONE MELAMINE TRAY

ACIER 18/10 FINITION MIROIR

18/10 STAINLESS STEEL TRAY  
MIRROR FINISH



**234546**  
**PLATEAU GN 1/1**  
TRAY GN 1/1  
L 53 cm L 20 in<sup>7/8</sup>  
l 32,5 cm W 12 in<sup>13/16</sup>



**234547**  
**PLATEAU GN 1/1**  
TRAY GN 1/1  
L 53 cm L 20 in<sup>7/8</sup>  
l 32,5 cm W 12 in<sup>13/16</sup>



**238962**  
**PLATEAU RECTANGULAIRE**  
RECTANGULAR TRAY  
L 53 cm L 20 in<sup>7/8</sup>  
l 32,5 cm W 12 in<sup>13/16</sup>



**234548**  
**PLATEAU GN 2/3**  
TRAY GN 2/3  
L 35,4 cm L 13 in<sup>15/16</sup>  
l 32,5 cm W 12 in<sup>13/16</sup>



**234549**  
**PLATEAU GN 2/3**  
TRAY GN 2/3  
L 35,4 cm L 13 in<sup>15/16</sup>  
l 32,5 cm W 12 in<sup>13/16</sup>



**234551**  
**PLATEAU GN 1/2**  
TRAY GN 1/2  
L 32,5 cm L 12 in<sup>13/16</sup>  
l 26,4 cm W 10 in<sup>3/8</sup>



**234552**  
**PLATEAU GN 1/2**  
TRAY GN 1/2  
L 32,5 cm L 12 in<sup>13/16</sup>  
l 26,4 cm W 10 in<sup>3/8</sup>



**238960**  
**PLATEAU RECTANGULAIRE**  
RECTANGULAR TRAY  
L 32,5 cm L 12 in<sup>13/16</sup>  
l 26,5 cm W 10 in<sup>7/16</sup>



**234553**  
**PLATEAU GN 1/3**  
TRAY GN 1/3  
L 32,5 cm L 12 in<sup>13/16</sup>  
l 17,5 cm W 6 in<sup>7/8</sup>



**234554**  
**PLATEAU GN 1/3**  
TRAY GN 1/3  
L 32,5 cm L 12 in<sup>13/16</sup>  
l 17,5 cm W 6 in<sup>7/8</sup>



**234557**  
**PLATEAU GN 1/6 - 3 TROUS**  
TRAY GN 1/6 - 3 HOLES  
L 32,5 cm L 12 in<sup>13/16</sup>  
l 8,7 cm W 3 in<sup>7/16</sup>



**234558**  
**PLATEAU GN 1/6 - 3 TROUS**  
TRAY GN 1/6 - 3 HOLES  
L 32,5 cm L 12 in<sup>13/16</sup>  
l 8,7 cm W 3 in<sup>7/16</sup>

(1) COMPATIBLE LAVE-VAISSELLE, NON COMPATIBLE MICRO-ONDES  
DISH WASHER SAFE, DONT USE WITH MICRO-WAVE

**VERRE**  
TEMPERED GLASS



**230752**  
**PLATEAU GN 1/1**  
TRAY GN 1/1  
L 53 cm L 20 in<sup>7/8</sup>  
l 32,5 cm W 12 in<sup>13/16</sup>  
E 0,6 cm T 0 in<sup>1/4</sup>



**230753**  
**PLATEAU GN 2/3**  
TRAY GN 2/3  
L 35,4 cm L 13 in<sup>15/16</sup>  
l 32,5 cm W 12 in<sup>13/16</sup>  
E 0,6 cm T 0 in<sup>1/4</sup>

**ACRYLIQUE**  
ACRYLIC

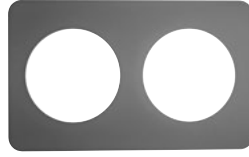

**230756**  
**PLATEAU GN 1/1 - 2 TROUS**  
TRAY GN 1/1 - 2 HOLES  
L 53 cm L 20 in<sup>7/8</sup>  
l 32,5 cm W 12 in<sup>13/16</sup>  
E 0,6 cm T 0 in<sup>1/4</sup>



**230757**  
**PLATEAU GN 1/3 - 2 TROUS**  
TRAY GN 1/3 - 2 HOLES  
L 32,5 cm L 12 in<sup>13/16</sup>  
l 17,5 cm W 6 in<sup>7/8</sup>  
E 0,6 cm T 0 in<sup>1/4</sup>

COMPATIBLE AVEC LES BOLS  
COMPATIBLE WITH THE BOWLS



**136511**  
**BOL**  
BOWL  
130 cl 43 oz<sup>15/16</sup>  
H 9,5 cm H 3 in<sup>3/4</sup>  
Ø 20 cm Ø 7 in<sup>7/8</sup>

**136529**  
**BOL**  
BOWL  
200 cl 67 oz<sup>5/8</sup>  
H 11 cm H 4 in<sup>5/16</sup>  
Ø 24 cm Ø 9 in<sup>7/16</sup>

**GRÈS ONYX (2)**  
ONYX STONEWARE



**245097**  
**PLATEAU GN 2/3**  
TRAY GN 2/3  
L 35,4 cm L 13 in<sup>15/16</sup>  
l 32,5 cm W 12 in<sup>13/16</sup>



**245098**  
**PLATEAU GN 1/3**  
TRAY GN 1/3  
L 32,5 cm L 12 in<sup>13/16</sup>  
l 17,5 cm W 6 in<sup>7/8</sup>



**245099**  
**PLAT CREUX GN 1/3**  
DEEP DISH GN 1/3  
L 32,5 cm L 12 in<sup>13/16</sup>  
l 17,5 cm W 6 in<sup>7/8</sup>

**PORCELAINÉ (2)**  
WHITE ENAMELLED  
PORCELAIN



**202628**  
**PLATEAU GN 2/3**  
TRAY GN 2/3  
L 35,4 cm L 13 in<sup>15/16</sup>  
l 32,5 cm W 12 in<sup>13/16</sup>



**202629**  
**PLATEAU GN 1/2**  
TRAY GN 1/2  
L 32,5 cm L 12 in<sup>13/16</sup>  
l 26,5 cm W 10 in<sup>7/16</sup>



**202627**  
**PLATEAU GN 1/3**  
TRAY GN 1/3  
L 32,5 cm L 12 in<sup>13/16</sup>  
l 17,5 cm W 6 in<sup>7/8</sup>

(2) COMPATIBLE LAVE-VAISSELLE, COMPATIBLE MICRO-ONDES  
DISH WASHER SAFE, MICROWAVE SAFE

# URNE À JUS DE FRUITS FRUIT JUICE DISPENSER

Urne à jus de fruit dotée d'un tube central en acier pour glace pilée : parfait maintien de la fraîcheur

*Fruit juice urn with central steel tube to hold crushed ice, for perfect freshness*



## FINITION MIROIR MIRROR FINISH

**231303**  
**URNE À JUS DE FRUITS**  
JUICE DISPENSER  
4 L 135 oz<sup>1/4</sup>  
L 20 cm L 7 in<sup>7/8</sup>  
H 45 cm H 17 in<sup>11/16</sup>  
l 32 cm W 12 in<sup>5/8</sup>

## FINITION BROSSÉE BRUSHED FINISH

**231304**  
**URNE À JUS DE FRUITS**  
JUICE DISPENSER  
4 L 135 oz<sup>1/4</sup>  
L 20 cm L 7 in<sup>7/8</sup>  
H 45 cm H 17 in<sup>11/16</sup>  
l 32 cm W 12 in<sup>5/8</sup>

**CRISTALLIN**  
**SOUFFLÉ BOUCHE**  
HAND BLOWN  
CRYSTALLINE



**202639**  
**CARAFE**  
120 cl 40 oz<sup>9/16</sup>  
H 27,5 cm H 10 in<sup>13/16</sup>  
Ø 10,5 cm Ø 4 in<sup>1/8</sup>

**PORCELAINE**  
WHITE ENAMELLED  
PORCELAIN



**202636**  
**CARAFE À LAIT**  
MILK JUG  
1,2 L 40 oz<sup>9/16</sup>  
H 27,5 cm H 10 in<sup>13/16</sup>  
Ø 10,5 cm Ø 4 in<sup>1/8</sup>

**BOUCHON VERSEUR,**  
**POUR UNE MEILLEURE HYGIÈNE**  
HYGIENIC POURING STOPPER



**202855**  
**BOUCHON DE CARAFE SILICONE**  
STOPPER FOR CARAFE SILICONE  
H 4,2 cm H 1 in<sup>5/8</sup>  
Ø 6,5 cm Ø 2 in<sup>9/16</sup>

# DISTRIBUTEURS À CÉRÉALES CEREAL DISPENSERS

Distributeurs à céréales 1 ou 3 tubes avec ailettes souples pour ne pas casser les céréales  
Cereal dispenser 1 or 3 tubs with flexible spout so as not to break the cereals



**231300**  
DISTRIBUTEUR À CÉRÉALES X 3  
CEREAL DISPENSER X 3  
3 x 3,5 L 101 oz<sup>7/16</sup>  
L 50 cm L 19 in<sup>11/16</sup>  
H 55 cm H 21 in<sup>5/8</sup>  
I 20 cm W 7 in<sup>7/8</sup>



**231299**  
DISTRIBUTEUR À CÉRÉALES  
CEREAL DISPENSER  
3,5 L 118 oz<sup>3/8</sup>  
L 20 cm L 7 in<sup>7/8</sup>  
H 55 cm H 21 in<sup>5/8</sup>  
I 20 cm W 7 in<sup>7/8</sup>



**237501**  
RAFRACHISSEUR DOUBLE  
PAROI  
DOUBLE WALL WINE COOLER



**154245**  
BOL  
BOWL  
55 cl 18 oz<sup>5/8</sup>  
H 8 cm H 3 in<sup>1/8</sup>  
Ø 14 cm Ø 5 in<sup>1/2</sup>



**202626**  
BOL  
BOWL  
39 cl 13 oz<sup>3/16</sup>  
Ø 13,5 cm Ø 5 in<sup>5/16</sup>



**202632**  
ETIQUETTE PORCELAIN  
MAGNÉTIQUE + SUPPORT ACIER  
MAGNETIC PORCELAIN NAME  
PLATE + STAINLESS STEEL  
STAND  
L 10 cm L 3 in<sup>15/16</sup>  
I 5 cm W 1 in<sup>15/16</sup>

CERTAINES PIÈCES SONT DISPONIBLES EN PIÈCES DÉTACHÉES (VOIR PAGE 287)  
SOME ITEMS ARE AVAILABLE INDIVIDUALLY (SEE PAGE 287)





# SUPPORTS DE PRÉSENTATION

## DISPLAY STANDS



Panière reversible pour une présentation droite ou inclinée  
*Reversible basket for a level or titled display*

# SUPPORTS DE PRÉSENTATION RECTANGULAIRES

## RECTANGULAR DISPLAY STANDS

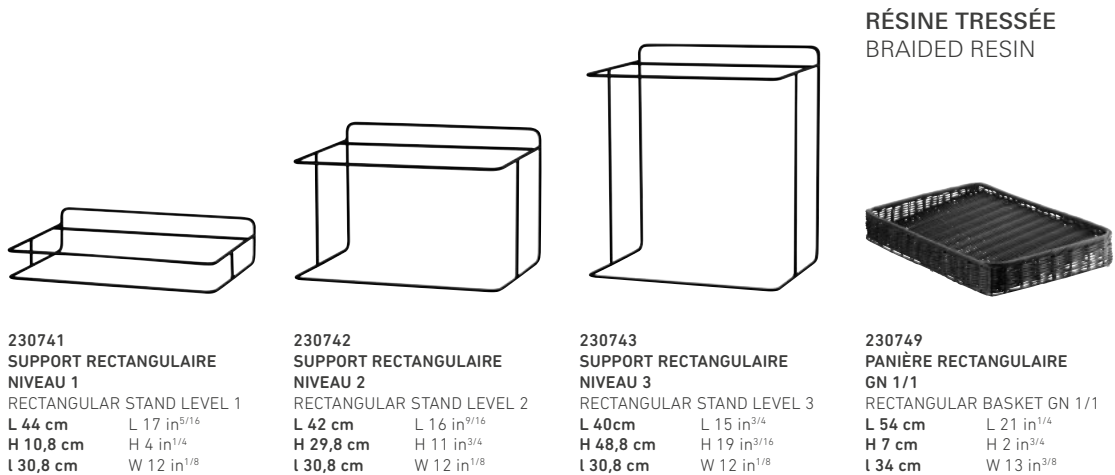

RÉSINE TRESSÉE  
BRAIDED RESIN

**230741**  
SUPPORT RECTANGULAIRE  
NIVEAU 1  
RECTANGULAR STAND LEVEL 1  
L 44 cm L 17 in<sup>5/16</sup>  
H 10,8 cm H 4 in<sup>1/4</sup>  
l 30,8 cm W 12 in<sup>1/8</sup>

**230742**  
SUPPORT RECTANGULAIRE  
NIVEAU 2  
RECTANGULAR STAND LEVEL 2  
L 42 cm L 16 in<sup>9/16</sup>  
H 29,8 cm H 11 in<sup>3/4</sup>  
l 30,8 cm W 12 in<sup>1/8</sup>

**230743**  
SUPPORT RECTANGULAIRE  
NIVEAU 3  
RECTANGULAR STAND LEVEL 3  
L 40 cm L 15 in<sup>3/4</sup>  
H 48,8 cm H 19 in<sup>3/16</sup>  
l 30,8 cm W 12 in<sup>1/8</sup>

**230749**  
PANIÈRE RECTANGULAIRE  
GN 1/1  
RECTANGULAR BASKET GN 1/1  
L 54 cm L 21 in<sup>1/4</sup>  
H 7 cm H 2 in<sup>3/4</sup>  
l 34 cm W 13 in<sup>3/8</sup>

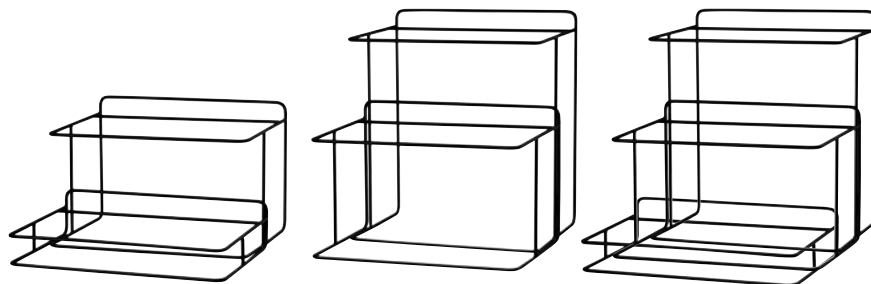

**230741+230742**  
SUPPORT RECTANGULAIRE  
NIVEAU 1+2  
RECTANGULAR TRAY, LEVEL  
1 + 2  
L 44 cm W 17 in<sup>5/16</sup>  
P 50 cm D 19 in<sup>11/16</sup>  
H 29,8 cm H 11 in<sup>3/4</sup>

**230742+230743**  
SUPPORT RECTANGULAIRE  
NIVEAU 2+3  
RECTANGULAR TRAY, LEVEL  
2 + 3  
L 42 cm W 16 in<sup>9/16</sup>  
P 50 cm D 19 in<sup>11/16</sup>  
H 48,8 cm H 19 in<sup>3/16</sup>

**230741+230742+230743**  
SUPPORT RECTANGULAIRE  
NIVEAU 1+2+3  
RECTANGULAR TRAY, LEVEL  
+ 2 + 3  
L 44 cm W 17 in<sup>5/16</sup>  
P 68,2 cm D 26 in<sup>7/8</sup>  
H 48,8 cm H 19 in<sup>3/16</sup>

# SUPPORTS DE PRÉSENTATION ROND

## ROUND DISPLAY STAND



GRÈS ONYX<sup>(1)</sup>  
ONYX STONEWARE

RÉSINE TRESSÉE - BRAIDED RESIN

**230745**  
SUPPORT ROND BAS  
ROUND STAND LOW LEVEL  
H 13 cm H 5 in<sup>1/8</sup>  
Ø 25 cm Ø 9 in<sup>13/16</sup>

**230746**  
SUPPORT ROND HAUT  
ROUND STAND HIGH LEVEL  
H 26 cm H 10 in<sup>1/4</sup>  
Ø 25 cm Ø 9 in<sup>13/16</sup>

**245100**  
SALADIER  
SALAD BOWL  
H 7 cm H 2 in<sup>3/4</sup>  
Ø 25,4 cm Ø 10 in

**230750**  
PANIÈRE RONDE  
ROUND BASKET  
H 6 cm H 2 in<sup>3/8</sup>  
Ø 18 cm Ø 7 in<sup>1/16</sup>

**230748**  
PANIÈRE RONDE  
ROUND BASKET  
H 8 cm H 3 in<sup>1/8</sup>  
Ø 32 cm Ø 12 in<sup>5/8</sup>



**230744**  
**CADRE ACIER NOIR POUR**  
**SUPPORT RECTANGULAIRE**  
 BLACK STEEL FRAME FOR  
 RECTANGULAR STAND  
**L 55,5 cm**    L 21 in<sup>7/8</sup>  
**H 4,5 cm**    H 1 in<sup>3/4</sup>  
**L 35 cm**    W 13 in<sup>3/4</sup>

**202854**  
**PLANCHE À PAIN BAMBOU AVEC**  
**RÉCUPÉRATEUR DE MIETTES**  
 BAMBOO BREAD BOARD WITH  
 CRUMB TRAY  
**L 53 cm**    L 20 in<sup>7/8</sup>  
**L 32,5 cm**    W 12 in<sup>13/16</sup>

**MÉLAMINE BOIS<sup>(1)</sup>**  
 WOOD MELAMINE TRAY

**MÉLAMINE PIERRE<sup>(1)</sup>**  
 STONE MELAMINE TRAY

**ACIER 18/10**  
**FINITION MIROIR**  
 18/10 STAINLESS STEEL  
 TRAY MIRROR FINISH

**VERRE**  
 TEMPERED GLASS



**234546**  
**PLATEAU GN 1/1**  
 TRAY GN 1/1  
**L 53 CM**    L 20 IN<sup>7/8</sup>  
**L 32,5 CM**    W 12 IN<sup>13/16</sup>

**234547**  
**PLATEAU GN 1/1**  
 TRAY GN 1/1  
**L 53 cm**    L 20 in<sup>7/8</sup>  
**L 32,5 cm**    W 12 in<sup>13/16</sup>

**238962**  
**PLATEAU RECTANGULAIRE**  
 RECTANGULAR TRAY  
**L 53 cm**    L 20 in<sup>7/8</sup>  
**L 32,5 cm**    W 12 in<sup>13/16</sup>

**230752**  
**PLATEAU GN 1/1**  
 TRAY GN 1/1  
**L 53 cm**    L 20 in<sup>7/8</sup>  
**L 32,5 cm**    W 12 in<sup>13/16</sup>  
**E 0,6 cm**    T 0 in<sup>1/4</sup>

**PORCELAINE<sup>(2)</sup>**  
 PORCELAIN



**234561**  
**PLATEAU ROND**  
 ROUND TRAY  
**Ø 32 cm**    Ø 12 in<sup>5/8</sup>

**234562**  
**PLATEAU ROND**  
 ROUND TRAY  
**Ø 32 cm**    Ø 12 in<sup>5/8</sup>

**136524**  
**PLAT À TARTE**  
 PIE DISH  
**Ø 32 cm**    Ø 12 in<sup>5/8</sup>

(1) COMPATIBLE LAVE-VAISSELLE, NON COMPATIBLE MICRO-ONDES  
 DISH WASHER SAFE, DONT USE WITH MICRO-WAVE

(2) COMPATIBLE LAVE-VAISSELLE, COMPATIBLE MICRO-ONDES  
 DISH WASHER SAFE, MICROWAVE SAFE



# PLANCHES LES ESSENCES

## BOARDS LES ESSENCES



CHÊNE - OAK



242942  
PLANCHE RONDE - CHÊNE  
ROUND BOARD - OAK  
Ø 29 cm    Ø 11 in<sup>7/16</sup>

COMPATIBLE AVEC  
COMPATIBLE WITH



247583  
CLOCHE EN VERRE  
GLASS DOME COVER  
H 20,5 cm    H 8 in<sup>1/16</sup>  
Ø 28 cm    Ø 11 in

NOYER - WALNUT



242946  
PLANCHE RONDE - NOYER  
ROUND BOARD - WALNUT  
Ø 29 cm    Ø 11 in<sup>7/16</sup>



242941  
PLANCHE FORME BAHIA -  
CHÊNE  
BAHIA BOARD - OAK  
L 35 cm    L 13 in<sup>3/4</sup>  
l 21 cm    W 8 in<sup>1/4</sup>



242945  
PLANCHE FORME BAHIA -  
NOYER  
BAHIA BOARD - WALNUT  
L 35 cm    L 13 in<sup>3/4</sup>  
l 21 cm    W 8 in<sup>1/4</sup>



242940  
PLANCHE CARRÉE - CHÊNE  
SQUARE BOARD - OAK  
L 37 cm    L 14 in<sup>7/16</sup>  
l 30 cm    W 11 in<sup>13/16</sup>



242944  
PLANCHE CARRÉE - NOYER  
SQUARE BOARD - WALNUT  
L 37 cm    L 14 in<sup>7/16</sup>  
l 30 cm    W 11 in<sup>13/16</sup>



242939  
PLANCHE ALLONGÉE - CHÊNE  
LONG BOARD - OAK  
L 50 cm    L 19 in<sup>11/16</sup>  
l 21 cm    W 8 in<sup>1/4</sup>



242943  
PLANCHE ALLONGÉE - NOYER  
LONG BOARD - WALNUT  
L 50 cm    L 19 in<sup>11/16</sup>  
l 21 cm    W 8 in<sup>1/4</sup>

ÉPAISSEUR 2 CM  
THICKNESS IN<sup>9/16</sup>

# ACCESSOIRES ACCESSORIES



**142722**  
**SALADIER**  
SERVING BOWL  
250 cl 84 oz<sup>9/16</sup>  
H 12,4 cm H 4 in<sup>7/8</sup>  
Ø 28 cm Ø 11 in



**209382**  
**PRÉSENTOIR À GÂTEAUX**  
CAKE STAND  
Ø 32 cm Ø 12 in<sup>5/8</sup>



**247581**  
**CLOCHE EN VERRE**  
GLASS DOME COVER  
H 13 cm H 5 in<sup>1/8</sup>  
Ø 16 cm Ø 6 in<sup>5/16</sup>



**247582**  
**CLOCHE EN VERRE**  
GLASS DOME COVER  
H 16,5 cm H 6 in<sup>1/2</sup>  
Ø 23 cm Ø 9 in<sup>1/16</sup>



**247583**  
**CLOCHE EN VERRE**  
GLASS DOME COVER  
H 20,5 cm H 8 in<sup>1/16</sup>  
Ø 28 cm Ø 11 in



**202633**  
**SUPPORT COUVERTS DE SERVICE**  
SERVING CUTLERY DISPLAY  
L 21 cm L 8 in<sup>1/4</sup>  
H 5 cm H 1 in<sup>15/16</sup>  
L 10 cm W 3 in<sup>15/16</sup>



**202632**  
**ETIQUETTE PORCELAINE MAGNÉTIQUE + SUPPORT ACIER**  
MAGNETIC PORCELAIN NAME PLATE + STAINLESS STEEL STAND  
L 10 cm L 3 in<sup>15/16</sup>  
L 5 cm W 1 in<sup>15/16</sup>

## MÉLAMINE BOIS<sup>(2)</sup> WOOD MELAMINE TRAY



**234559**  
**PLANCHA AVEC MANCHE (1)**  
BOARD WITH HANDLE  
L 45 CM L 17 IN<sup>11/16</sup>  
L 17,5 CM W 6 IN<sup>7/8</sup>

## MÉLAMINE PIERRE<sup>(2)</sup> STONE MELAMINE TRAY



**234560**  
**PLANCHA AVEC MANCHE**  
BOARD WITH HANDLE  
L 45 cm L 17 in<sup>11/16</sup>  
L 17,5 cm W 6 in<sup>7/8</sup>



■ **204496**  
■ **101494**  
**Ciseaux à gâteaux**  
PASTRY SCISSOR  
L 195 mm L 7 in<sup>11/16</sup>



■ **204499**  
■ **1184355**  
**PINCE À SERVIR**  
SERVING TONG  
L 295 mm L 11 in<sup>5/8</sup>



■ **204498**  
■ **101492**  
**PINCE À PAIN**  
BREAD TONG  
L 231 mm L 9 in<sup>1/8</sup>



■ **153193**  
**LOUCHE**  
SOUP LADLE  
L 297 mm L 11 in<sup>11/16</sup>

(1) PLANCHE DE PRÉSENTATION UNIQUEMENT, NE PAS FAIRE DE DÉCOUPE  
PRESENTATION BOARD, DONT CUT ON IT

(2) COMPATIBLE LAVE-VAISSELLE, NON COMPATIBLE MICRO-ONDES  
DISH WASHER SAFE, DONT USE WITH MICRO-WAVE

**PIERRE DE LUNE**  
MOONSTONE  
PORCELAIN - PORCELAIN



**239325**  
**SALADIER**  
SERVING BOWL  
400 ct 135 oz<sup>1/4</sup>  
Ø 28 cm Ø 11 in

**DUNE**  
BEIGE DUNE  
GRÈS - STONEWARE



**235223**  
**SALADIER**  
SERVING BOWL  
400 ct 135 oz<sup>1/4</sup>  
Ø 28 cm Ø 11 in

**BLEU DE ROCHE**  
BLUE STONE  
GRÈS - STONEWARE



**235222**  
**SALADIER**  
SERVING BOWL  
400 ct 135 oz<sup>1/4</sup>  
Ø 28 cm Ø 11 in

**ONYX**  
BLACK ONYX  
GRÈS - STONEWARE

**ARGILE VERTE**  
GREEN CLAY  
GRÈS - STONEWARE



**242055**  
**PLANCHE RONDE**  
ROUND BOARD  
Ø 29 cm Ø 11 in<sup>7/16</sup>



**242057**  
**PLANCHE RONDE**  
ROUND BOARD  
Ø 29 cm Ø 11 in<sup>7/16</sup>



**242053**  
**PLANCHE RONDE**  
ROUND BOARD  
Ø 29 cm Ø 11 in<sup>7/16</sup>



**242054**  
**PLANCHE**  
BOARD  
L 35 cm L 13 in<sup>3/4</sup>  
l 21 cm W 8 in<sup>1/4</sup>



**242056**  
**PLANCHE**  
BOARD  
L 35 cm L 13 in<sup>3/4</sup>  
l 21 cm W 8 in<sup>1/4</sup>



**242052**  
**PLANCHE**  
BOARD  
L 35 cm L 13 in<sup>3/4</sup>  
l 21 cm W 8 in<sup>1/4</sup>



**237206**  
**PLANCHE**  
BOARD  
L 25 cm L 9 in<sup>13/16</sup>  
l 13,5 cm W 5 in<sup>5/16</sup>



**234949**  
**PLANCHE**  
BOARD  
L 25 cm L 9 in<sup>13/16</sup>  
l 13,5 cm W 5 in<sup>5/16</sup>

**234948**  
**PLANCHE**  
BOARD  
L 25 cm L 9 in<sup>13/16</sup>  
l 13,5 cm W 5 in<sup>5/16</sup>

**234950**  
**PLANCHE**  
BOARD  
L 25 cm L 9 in<sup>13/16</sup>  
l 13,5 cm W 5 in<sup>5/16</sup>



**PLATS À FOUR**  
BAKING DISHES

**241833**  
L 15,5 cm L 6 in<sup>1/8</sup>  
H 4,4 cm H 1 in<sup>3/4</sup>  
l 10,7 cm W 4 in<sup>3/16</sup>

**241834**  
L 22,8 cm L 9 in  
H 5,4 cm H 2 in<sup>1/8</sup>  
l 16,2 cm W 6 in<sup>3/8</sup>



**PLATS À FOUR**  
BAKING DISHES

**237594**  
L 22,8 cm L 9 in  
H 5,4 cm H 2 in<sup>1/8</sup>  
l 16,2 cm W 6 in<sup>3/8</sup>

**237593**  
L 15,5 cm L 6 in<sup>1/8</sup>  
H 4,4 cm H 1 in<sup>3/4</sup>  
l 10,7 cm W 4 in<sup>3/16</sup>

# PIÈCES DÉTACHÉES

## CHAFING DISH



**203470**  
**COUVERCLE AVEC GOUTTIÈRE ACIER - VERRE TREMPÉ**  
LID WITH STAINLESS STEEL GUTTER - TEMPERED GLASS  
**Ø 33 cm**      Ø 13 in

**230050**  
**JOINT POUR CHAFING DISH**  
SEAL FOR CHAFING DISH

**247023**  
**KIT RÉPARATION CHARNIÈRES CHAFING DISH**  
CHAFING DISH HINGE REPAIR KIT

## MODULES FROID REFRIGERATED UNIT



**202866**  
**BAC PLASTIQUE MODULE FROID GN 1/1**  
PLASTIC CONTAINER GN 1/1 REFRIGERATED SET  
**L 56 cm**      L 22 in<sup>1/16</sup>  
**H 8 cm**      H 3 in<sup>1/8</sup>  
**l 35,5 cm**      W 14 in



**235357**  
**BAC PLASTIQUE MODULE FROID GN 1/2**  
PLASTIC CONTAINER GN 1/2 REFRIGERATED SET  
**L 35,6 cm**      L 14 in  
**H 8 cm**      H 3 in<sup>1/8</sup>  
**l 29,5 cm**      W 11 in<sup>5/8</sup>



# PIÈCES DÉTACHÉES

## URNE À JUS DE FRUITS FRUIT JUICE URN

MIROIR - MIRROR

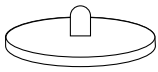

202881  
COUVERCLE URNE À JUS -  
ACIER 18-10  
LID FOR JUICE URN - STAINLESS  
STEEL  
Ø 17,9 cm    Ø 7 in<sup>1/16</sup>

BROSSÉ - BRUSHED

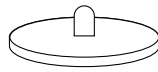

202891  
COUVERCLE URNE À JUS -  
ACIER 18-10  
LID FOR JUICE DISPENSER -  
STAINLESS STEEL  
Ø 17,9 cm    Ø 7 in<sup>1/16</sup>

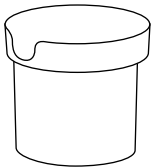

202890  
BASE ACIER URNE À JUS  
STAINLESS STEEL STAND FOR  
JUICE DISPENSER  
H 19 cm    H 7 in<sup>1/2</sup>  
Ø 17,6 cm    Ø 6 in<sup>15/16</sup>

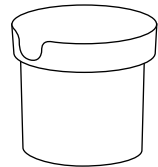

202889  
BASE ACIER URNE À JUS  
STAINLESS STEEL STAND FOR  
JUICE DISPENSER  
H 19 cm    H 7 in<sup>1/2</sup>  
Ø 17,6 cm    Ø 6 in<sup>15/16</sup>

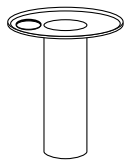

202884  
TUBE ACIER POUR GLACE  
ICE TUBE STAINLESS STEEL  
H 22 cm    H 8 in<sup>11/16</sup>  
Ø 9 cm    Ø 3 in<sup>9/16</sup>

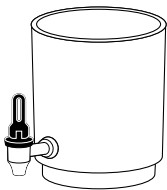

202883  
FUT CYLINDRIQUE POUR URNE  
À JUS  
CYLINDRICAL TUBE FOR JUICE  
CONTAINER  
Ø 17,7 cm    Ø 6 in<sup>15/16</sup>

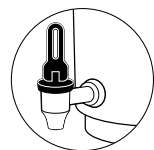

214724  
ROBINET POUR URNE À JUS -  
POIGNÉE NOIRE  
FAUCET FOR JUICE DISPENSER -  
BLACK HANDLE



045963  
GRILLE ACIER  
STAINLESS STEEL GRID  
Ø 9 cm    Ø 3 in<sup>9/16</sup>

230758  
SOCLE ACRYLIQUE NOIR URNE  
À JUS  
BLACK ACRYLIC STAND FOR  
JUICE DISPENSER  
L 32 cm    L 12 in<sup>5/8</sup>  
l 20 cm    W 7 in<sup>7/8</sup>

## DISTRIBUTEURS À CÉRÉALES CEREAL DISPENSER

MIROIR - MIRROR



213078  
COUVERCLE DISTRIBUTEUR À  
CÉRÉALES - ACIER 18-10  
LID FOR CEREAL DISPENSER -  
STAINLESS STEEL  
Ø 12,5 cm    Ø 4 in<sup>15/16</sup>

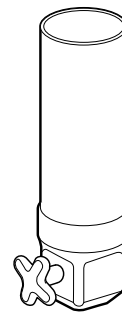

213076  
FUT CYLINDRIQUE AVEC  
AILETTE ET POIGNÉE  
DISTRIBUTEUR À CÉRÉALES  
BARREL + HANDLE + ROLLING  
TAP FOR CEREAL DISPENSER

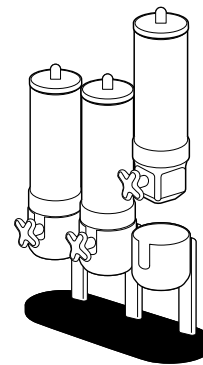

231302  
BASE + TUBE + SOCLE X3  
DISTRIBUTEUR À CÉRÉALES  
STAINLESS STEEL STAND + TUB  
+ ACRYLIC STAND FOR CEREAL  
DISPENSER X3  
L 50 cm    L 19 in<sup>11/16</sup>  
H 27,5 cm    H 10 in<sup>13/16</sup>

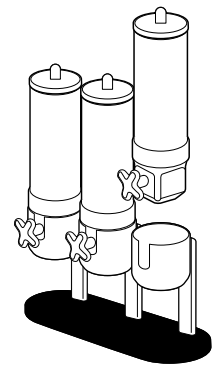

231301  
BASE + TUBE + SOCLE X1  
DISTRIBUTEUR À CÉRÉALES  
STAINLESS STEEL STAND + TUB  
+ ACRYLIC STAND FOR CEREAL  
DISPENSER X  
L 50 cm    L 19 in<sup>11/16</sup>  
H 27,5 cm    H 10 in<sup>13/16</sup>



**ARGENTURE CLASSE 1 - 33 MICRONS**  
(POUR LES ARTICLES À USAGE FRÉQUENT)  
CLASS 1 SILVER PLATED - 33 MICRONS



**ÉPAISSEUR FOURCHETTE DE TABLE**  
THICKNESS TABLE FORK



**VERRE**  
GLASS



**ARGENTURE QUALITÉ HÔTELIÈRE**  
**10 MICRONS**  
SILVER PLATED HOTEL QUALITY- 10 MICRONS



**PVD** **REVÊTEMENT PVD**  
PVD COATING



**CRISTALLIN HAUTE QUALITÉ**  
HQ LOW LEAD CRYSTAL



**FINITION MIROIR**  
MIRROR FINISH



**P** **PORCELAINE**  
PORCELAIN



**VERRE SOUFFLÉ BOUCHE**  
**TEINTÉ DANS LA MASSE**  
HAND-BLOWN INTEGRALLY DYED GLASS



**FINITION SATINÉE**  
SATIN FINISH



**GRÈS**  
STONEWARE



**1000 CYCLES GARANTIS MINIMUM**  
1000 WASH CYCLES GUARANTEED



**FINITION BROSSÉE**  
BRUSHED FINISH



**EMPILABILITÉ**  
STACKABLE



**500 CYCLES GARANTIS MINIMUM**  
500 WASH CYCLES GUARANTEED



**FINITION VINTAGE**  
VINTAGE FINISH



**RÉSISTE AUX CHOCS**  
SHOCK RESISTANT



**VERRE TAILLÉ**  
CUT GLASS



**F** **FORGÉ**  
FORGED



**RÉSISTE AUX TACHES**  
STAIN RESISTANT



**GARANTIE MICRO-ONDES**  
MICROWAVE SAFE



**18%** **ACIER INOXYDABLE 18%**  
STAINLESS STEEL 18%



**MÉTAL PRÉCIEUX PEINT À LA MAIN**  
HAND-PAINTED PRECIOUS METAL



**GARANTIE LAVE-VAISSELLE**  
DISHWASHER SAFE



**18-10** **ACIER INOXYDABLE 18-10**  
STAINLESS STEEL 18-10



**FABRIQUÉ EN FRANCE**  
MADE IN FRANCE



**FABRIQUÉ EN EUROPE**  
MADE IN EUROPE

**FRANCE USA**

**SIÈGE SOCIAL/HEAD OFFICE**  
**SERVICE CLIENTS/CUSTOMER SERVICES**

**FILIALE USA/US SUBSIDIARY**

**RUE GUY DEGRENNE - BP 50056**  
**14502 VIRE CEDEX**  
**TEL : +33 02 31 66 44 15**

**DNA/DEGRENNE NORTH AMERICA INC.**  
**301 OXFORD VALLEY ROAD, SUITE 1903-B,**  
**YARDLEY, PA 19067**

**OTHER COUNTRIES**  
**TEL : +33 02 31 66 44 00**

**TEL : +1 732 565 0820**  
**FAX : +1 732 565 0828**

**infohotel@guydegrenne.fr**

**csvr.dna@guydegrenne.com**  
**www.degrennenorthamerica.com**

**SHOWROOM (BY APPOINTMENT)**  
**41 MADISON AVENUE, 15TH FLOOR**  
**NEW YORK, NY 10010**

**WWW.PRO.GUYDEGRENNE.FR**



